

CATALOG
HEAVY LINE
2022
REVIEW-1

• OIL SEAL • GASKETS • SCREWS

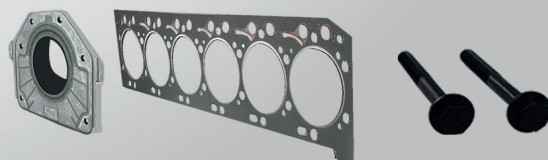

DESCRIPTION	PAGE
TORQUE	4
TORQUE	5
INDEX	6
INDEX - CUMMINS	7
INDEX - MERCEDES	8
INDEX - MERCEDES - MWM	9
INDEX - MAXION PERKINS	10
INDEX - IVECO - SCANIA - JOHN DEERE	11
INDEX - FORD	12
INDEX - VALTRA - NEW RELEASES	13
SUBTITLES AND SPECIFICATIONS	14



TORQUE

TORQUE - HEAVY LINE

LINE	Nº ABR	CYLINDER HEAD GASKET APPLICATION	GASKET	TIGHTENING SEQUENCE	MOUNTING TORQUE	Ø CYLINDER
VOLKSWAGEN	58512701	KOMBI DIESEL 1.6			1 PHASE 2 KGFM 2 PHASE 4 KGFM 3 PHASE 6 KGFM 4 PHASE 180° 5 PHASE 90°	Ø 76,5 MM
MERCEDES BENZ	56131803	MERCEDES OM - 314			1 PHASE 6 KGFM 2 PHASE 9 KGFM 3 PHASE 12 A 13 KGFM	Ø 97,0 MM
MERCEDES BENZ	56108701	MERCEDES OM -364			1 PHASE 6 KGFM 2 PHASE 9 KGFM 3 PHASE 12 A 13 KGFM 4 PHASE PARAFUSO DODCAGONAL 90°	Ø 97,5 MM
MERCEDES BENZ	56137200	MERCEDES OM - 447 / 449			1 PHASE 1 KGFM 2 PHASE 5 KGFM 3 PHASE 10 KGFM 4 PHASE 14 KGFM 5 PHASE 18 A 19 KGFM 6 PHASE 90° A 100°	Ø 128,0 MM
MERCEDES BENZ	56169405	MERCEDES OM 457 ELETRÔNICO			1 PHASE 2 KGFM 2 PHASE 6 KGFM 3 PHASE 12 KGFM 4 PHASE 18 KGFM 5 PHASE 90° A 100° 6 PHASE 90° A 100°	Ø 128,0 MM
MERCEDES BENZ	56149603	MERCEDES OM 352 / 352A			1 PHASE 6 KGFM 2 PHASE 9 KGFM 3 PHASE 12 A 13 KGFM	Ø 97,5 MM
MERCEDES BENZ	56150201	MERCEDES OM 352A / OM 366 / OM 366A / OM 366 LA			1 PHASE 6 KGFM 2 PHASE 9 KGFM 3 PHASE 12 A 13 KGFM 4 PHASE PARAFUSO DODECAGONAL 90°	Ø 97,5 MM
MERCEDES BENZ	56173905 56173105	MERCEDES OM 904 ELETRÔNICO MERCEDES OM 924 ELETRÔNICO			1 PHASE 2 KGFM 2 PHASE 7 KGFM 3 PHASE 17 KGFM 4 PHASE 28 KGFM 5 PHASE 90° A 100° 6 PHASE 90° A 100°	Ø 904-102,0MM Ø 924-106,0MM
MERCEDES BENZ	56173005 56173205	MERCEDES OM 906 ELETRÔNICO MERCEDES OM 926 ELETRÔNICO			1 PHASE 2 KGFM 2 PHASE 7 KGFM 3 PHASE 17 KGFM 4 PHASE 28 KGFM 5 PHASE 90° A 100° 6 PHASE 90° A 100°	Ø 904-102,0MM Ø 924-106,0MM
MERCEDES BENZ	56111903	MERCEDES OM 355			1 PHASE 4 KGFM 2 PHASE 8 KGFM 3 PHASE 12 KGFM	Ø 128,0 MM
CUMMINS	58312601	CUMMINS ENGINE 4BT 4.9 4CYLINDERS			1 PHASE 8 KGFM (TODOS) 2 PHASE -90°+9KGFM (TODOS) 3 PHASE 12 KGFM (PARAFUSOS LONGOS) 4 PHASE 90° (TODOS)	Ø 102,0 MM
PERKINS	58312601	CUMMINS ENGINE 6BT 5.9 6CYLINDERS			1 PHASE 8 KGFM (TODOS) 2 PHASE -90°+9KGFM (TODOS) 3 PHASE 12 KGFM (PARAFUSOS LONGOS) 4 PHASE 90° (TODOS)	Ø 102,0 MM
PERKINS	56310501	CUMMINS ENGINE 6CT 8.3 6CYLINDERS			1 PHASE 7 KGFM 2 PHASE 15 KGFM 3 PHASE 22 KGFM	Ø 114,0 MM

LINE	Nº ABR	CYLINDER HEAD GASKET APPLICATION	GASKET	TIGHTENING SEQUENCE	MOUNTING TORQUE	Ø CYLINDER
MWM	50965300	MAXION HSD 2.5			1 PHASE 4 KGFM 2 PHASE 4 KGFM 3 PHASE -90°-4 KGFM 4 PHASE 60° 5 PHASE 60° 6 PHASE 20° PARAFUSO M20X140	Ø 114,0 MM
MWM	50971600	MAXION 6354.4 - Q208 6354.4			1 PHASE 4 KGFM 2 PHASE 8 KGFM 3 PHASE 13,5 KGFM 4 PHASE -90°-13,5 KGFM AFTER1000KM REPETIR 4° PHASE	MBB Ø 90,5 MM GM/FORD Ø 90,75 MM
MWM	50965504	PERKINS 4236/4248 Q20B 4236			1 PHASE 4 KGFM 2 PHASE 8 KGFM 3 PHASE 13 A 13,8 KGFM	Ø 98,48 MM
MWM	50953304	MAXION S4/S4T/S4T PLUS/P 4000			1 PHASE 3 KGFM 2 PHASE 120° 3 PHASE 180°	Ø 98,48 MM
MWM	50911701 50911601	PERKINS 4203(INJEÇÃO DIRETA) PERKINS 4203(INJEÇÃO INDIRETA)			1 PHASE 2 KGFM 2 PHASE 4 KGFM 3 PHASE 7 KGFM 4 PHASE 9 A 9,7 KGFM	Ø 100,0 MM
MWM	54395700	MWM SPRINT 4.07 4			1 PHASE 3 KGFM 2 PHASE 6 KGFM 3 PHASE 10 KGFM 4 PHASE 90° 5 PHASE 90°	Ø 91,48 MM
MWM	54395800	MWM SPRINT 6.07			1 PHASE 7 KGFM 2 PHASE 15 KGFM 3 PHASE 22 KGFM 1 PHASE 7 KGFM 2 PHASE 15 KGFM	Ø 93,0 MM
MWM	54319000	MWM D-229/TD 229			1 PHASE PARAFUSO 22MM 10 KGFM 2 PHASE PARAFUSO 22MM 15 KGFM 3 PHASE PARAFUSO 22MM 21 KGFM 1 PHASE PARAFUSO 17MM 6 A 7 KGFM 2 PHASE PARAFUSO 17MM 57° A 63° 3 PHASE PARAFUSO 17MM 57° A 63°	Ø 93,0 MM
MWM	54364904	MWM 4.10/6.10 9(X-10)			1 PHASE 6 A 7 KGFM 2 PHASE 60° 3 PHASE 60°	Ø 103,0 MM
MWM	543119202	MWM 4.12/6.12 (ACTEON)			1 PHASE 6 A 7 KGFM 2 PHASE 60° 3 PHASE 60°	Ø 105,0 MM



INDEX

CUMMINS

Nº ABR	ENGINE	DESCRIPTION		PAGE
68313943	4B/4BT	FULL GASKET SET	WITHOUT OIL SEAL	18
78313943	4B/4BT	FULL GASKET SET	WITH OIL SEAL	18
68333941	4B/4BT	HEAD GASKET SET	WITHOUT OIL SEAL	18
78333941	4B/4BT	HEAD GASKET SET	WITH OIL SEAL	18
68333940	4B/4BT	BOTTOM GASKET SET	WITHOUT OIL SEAL	18
78333940	4B/4BT	BOTTOM GASKET SET	WITH OIL SEAL	18
78310643	ISBe4 3.9L	FULL GASKET SET	WITH OIL SEAL	20
78330641	ISBe4 3.9L	HEAD GASKET SET	WITH OIL SEAL	20
78330640	ISBe4 3.9L	BOTTOM GASKET SET	WITH OIL SEAL	20
78310648	ISBe4 3.9L	FULL GASKET SET	WITH OIL SEAL WITHOUT JET COOLER	20
78330648	ISBe4 3.9L	HEAD GASKET SET	WITH OIL SEAL WITHOUT JET COOLER	20
68315943	6B/6BT	FULL GASKET SET	WITHOUT OIL SEAL	22
78315943	6B/6BT	FULL GASKET SET	WITH OIL SEAL	22
68335941	6B/6BT	HEAD GASKET SET	WITHOUT OIL SEAL	22
78335941	6B/6BT	HEAD GASKET SET	WITH OIL SEAL	22
68335940	6B/6BT	BOTTOM GASKET SET	WITHOUT OIL SEAL	22
78335940	6B/6BT	BOTTOM GASKET SET	WITH OIL SEAL	24
68310663	ISBe6 5.9L	FULL GASKET SET	WITHOUT OIL SEAL	24
78310663	ISBe6 5.9L	FULL GASKET SET	WITH OIL SEAL	24
68330661	ISBe6 5.9L	HEAD GASKET SET	WITHOUT OIL SEAL	24
78330661	ISBe6 5.9L	HEAD GASKET SET	WITH OIL SEAL	24
68330660	ISBe6 5.9L	BOTTOM GASKET SET	WITHOUT OIL SEAL	24
78330660	ISBe6 5.9L	BOTTOM GASKET SET	WITH OIL SEAL	24
78310668	ISBe6 5.9L	FULL GASKET SET	WITH OIL SEAL WITHOUT JET COOLER	24
68314943	6C/6CTA	FULL GASKET SET	WITHOUT OIL SEAL	26
78314943	6C/6CTA	FULL GASKET SET	WITH OIL SEAL	26
68334941	6C/6CTA	HEAD GASKET SET	WITHOUT OIL SEAL	26
78334941	6C/6CTA	HEAD GASKET SET	WITH OIL SEAL	26
68334940	6C/6CTA	BOTTOM GASKET SET	WITHOUT OIL SEAL	26
78334940	6C/6CTA	BOTTOM GASKET SET	WITH OIL SEAL	26
78314949	6C/6CTA	FULL GASKET SET	WITH OIL SEAL WITH O RINGS	26
78334949	6C/6CTA	BOTTOM GASKET SET	WITH OIL SEAL WITH O RINGS	26
68310593	ISC 8.3L/ ISL 8.9L	FULL GASKET SET	WITHOUT OIL SEAL	30
78310593	ISC 8.3L/ ISL 8.9L	FULL GASKET SET	WITH OIL SEAL	30
68330591	ISC 8.3L/ ISL 8.9L	HEAD GASKET SET	WITHOUT OIL SEAL	30
78330591	ISC 8.3L/ ISL 8.9L	HEAD GASKET SET	WITH OIL SEAL	30
68330590	ISC 8.3L/ ISL 8.9L	BOTTOM GASKET SET	WITHOUT OIL SEAL	30
78330590	ISC 8.3L/ ISL 8.9L	BOTTOM GASKET SET	WITH OIL SEAL	30
68310772	ISB4.5 / QSB4.5	FULL GASKET SET	WITHOUT OIL SEAL	32
78310772	ISB4.5 / QSB4.5	FULL GASKET SET	WITH OIL SEAL	32
68330771	ISB4.5 / QSB4.5	HEAD GASKET SET	WITHOUT OIL SEAL	32
78330771	ISB4.5 / QSB4.5	HEAD GASKET SET	WITH OIL SEAL	32
68330770	ISB4.5 / QSB4.5	BOTTOM GASKET SET	WITHOUT OIL SEAL	32
78330770	ISB4.5 / QSB4.5	BOTTOM GASKET SET	WITH OIL SEAL	32
68310752	ISB6.7/QSB6.7	FULL GASKET SET	WITHOUT OIL SEAL	32
78310778	ISB4.5 / QSB4.5	FULL GASKET SET	WITH OIL SEAL WITHOUT JET COOLER	32
78330778	ISB4.5 / QSB4.5	BOTTOM GASKET SET	WITH OIL SEAL WITHOUT JET COOLER	32
78310752	ISB6.7/QSB6.7	FULL GASKET SET	WITH OIL SEAL	34
68330751	ISB6.7/QSB6.7	HEAD GASKET SET	WITHOUT OIL SEAL	34
78330751	ISB6.7/QSB6.7	HEAD GASKET SET	WITH OIL SEAL	34
68330750	ISB6.7/QSB6.7	BOTTOM GASKET SET	WITHOUT OIL SEAL	34
78330750	ISB6.7/QSB6.7	BOTTOM GASKET SET	WITH OIL SEAL	34
78310758	ISB6.7/QSB6.7	FULL GASKET SET	WITH OIL SEAL WITHOUT JET COOLER	34
78330758	ISB6.7/QSB6.7	BOTTOM GASKET SET	WITH OIL SEAL WITHOUT JET COOLER	34
78310732	ISF 4 CYLINDERS.3.8L	FULL GASKET SET	WITH OIL SEAL	36
78330732	ISF 4 CYLINDERS.3.8L	HEAD GASKET SET	WITH OIL SEAL	36
78330730	ISF 4 CYLINDERS.3.8L	BOTTOM GASKET SET	WITH OIL SEAL	36
78310712	ISF 4 CYLINDERS.2.8L	FULL GASKET SET	WITH OIL SEAL	38
78330712	ISF 4 CYLINDERS.2.8L	HEAD GASKET SET	WITH OIL SEAL	38
78330710	ISF 4 CYLINDERS.2.8L	BOTTOM GASKET SET	WITH OIL SEAL	38

MERCEDES

Nº ABR	ENGINE	DESCRIPTION	PAGE	
66116081	OM314	FULL GASKET SET	WITHOUT OIL SEAL WITH CYLINDER HEAD GASKET 98,5 MM	40
76116081	OM314	FULL GASKET SET	WITH OIL SEAL WITH CYLINDER HEAD GASKET 98,5 MM	40
76126081	OM314	FULL GASKET SET	WITH OIL SEAL WITH CYLINDER HEAD GASKET 100,0 MM	40
76136081	OM314	HEAD GASKET SET	WITH OIL SEAL WITH CYLINDER HEAD GASKET 98,5 MM	40
76121681	OM364	FULL GASKET SET	WITH OIL SEAL WITH CYLINDER HEAD GASKET 98,5 MM	46
76111681	OM364	FULL GASKET SET	WITH OIL SEAL WITH CYLINDER HEAD GASKET 100,0 MM	46
76121671	OM364A	FULL GASKET SET	WITH OIL SEAL WITH CYLINDER HEAD GASKET 98,5 MM	46
76111671	OM364A	FULL GASKET SET	WITH OIL SEAL WITH CYLINDER HEAD GASKET 100,0 MM	46
76131671	OM364/364A	HEAD GASKET SET	WITH OIL SEAL WITH CYLINDER HEAD GASKET 98,5 MM	46
76131681	OM364/364A	HEAD GASKET SET	WITH OIL SEAL WITH CYLINDER HEAD GASKET 100,0 MM	46
76141721	OM352	FULL GASKET SET	WITH OIL SEAL WITH CYLINDER HEAD GASKET 98,5 MM	50
76121721	OM352	FULL GASKET SET	WITH OIL SEAL WITH CYLINDER HEAD GASKET 100,0 MM	50
76141031	OM352A/LA	FULL GASKET SET	WITH OIL SEAL WITH CYLINDER HEAD GASKET 98,5 MM	50
76121031	OM352A/LA	FULL GASKET SET	WITH OIL SEAL WITH CYLINDER HEAD GASKET 100,0 MM	50
76131721	OM352A/LA	HEAD GASKET SET	WITH OIL SEAL WITH CYLINDER HEAD GASKET 98,5 MM	50
76131031	OM352A/LA	HEAD GASKET SET	WITH OIL SEAL WITH CYLINDER HEAD GASKET 100,0 MM	50
66113121	OM355/5 CYLINDERS	FULL GASKET SET	WITHOUT OIL SEAL	54
76113121	OM355/5 CYLINDERS	FULL GASKET SET	WITH OIL SEAL	54
76133121	OM355/5 CYLINDERS	HEAD GASKET SET	WITH OIL SEAL	54
66112501	OM355/6 CYLINDERS	FULL GASKET SET	WITHOUT OIL SEAL	58
76112501	OM355/6 CYLINDERS	FULL GASKET SET	WITH OIL SEAL	58
76132501	OM355/6 CYLINDERS	HEAD GASKET SET	WITH OIL SEAL	58
76121691	OM366	FULL GASKET SET	WITH OIL SEAL WITH CYLINDER HEAD GASKET 98,5 MM	62
76111691	OM366	FULL GASKET SET	WITH OIL SEAL WITH CYLINDER HEAD GASKET 100,0 MM	62
76121701	OM366A	FULL GASKET SET	WITH OIL SEAL WITH CYLINDER HEAD GASKET 98,5 MM	62
76141701	OM366A	FULL GASKET SET	WITH OIL SEAL WITH CYLINDER HEAD GASKET 100,0 MM	62
76112791	OM366LA	FULL GASKET SET	WITH OIL SEAL WITH CYLINDER HEAD GASKET 100,0 MM	62
76131701	OM366A/366LA	HEAD GASKET SET	WITH OIL SEAL WITH CYLINDER HEAD GASKET 98,5 MM	62
76131691	OM366A/366LA	HEAD GASKET SET	WITH OIL SEAL WITH CYLINDER HEAD GASKET 100,0 MM	62
76196115	OM447A/447LA	FULL GASKET SET	WITH OIL SEAL	66
66196115	OM447A/447LA	FULL GASKET SET	WITHOUT OIL SEAL	66
76196125	OM449A/449LA	FULL GASKET SET	WITH OIL SEAL	66
66196125	OM449A/449LA	FULL GASKET SET	WITHOUT OIL SEAL	66
76136125	OM447/OM449	MONOCYLINDER GASKET SET	WITH OIL SEAL	66
66136125	OM447/OM449	MONOCYLINDER GASKET SET	WITHOUT OIL SEAL	66
66114611	OM457LA	FULL GASKET SET	WITHOUT OIL SEAL WITHOUT O RING (UP TO ENGINE 32558)	68
76114611	OM457LA	FULL GASKET SET	WITH OIL SEAL WITHOUT O RING (UP TO ENGINE 32558)	68
76114619	OM457LA	FULL GASKET SET	WITH OIL SEAL WITH O RING (UP TO ENGINE 32558)	68
66134611	OM457LA	MONOCYLINDER GASKET SET	WITHOUT OIL SEAL WITHOUT O RING (UP TO ENGINE 32558)	68
76134611	OM457LA	MONOCYLINDER GASKET SET	WITH OIL SEAL WITHOUT O RING (UP TO ENGINE 32558)	68
76134619	OM457LA	MONOCYLINDER GASKET SET	WITH OIL SEAL WITH O RING (UP TO ENGINE 32558)	68
66114631	OM457LA	FULL GASKET SET	WITHOUT OIL SEAL WITHOUT O RING (AFTER ENGINE 32559)	70
76114631	OM457LA	FULL GASKET SET	WITH OIL SEAL WITHOUT O RING (AFTER ENGINE 32559)	70
76114639	OM457LA	FULL GASKET SET	WITH OIL SEAL WITH O RING (AFTER ENGINE 32559)	70
76134599	OM457LA	MONOCYLINDER GASKET SET	WITH OIL SEAL WITH O RING (AFTER ENGINE 32559)	70
76134609	OM457LA	MONOCYLINDER GASKET SET	WITH OIL SEAL WITH O RING (AFTER ENGINE 32559)	70
76114651	OM611	FULL GASKET SET	WITH OIL SEAL	72
76134651	OM611	HEAD GASKET SET	WITH OIL SEAL	72
76119041	OM904	FULL GASKET SET	WITH OIL SEAL FOR PLASTIC VALVE COVER	74
66119041	OM904	FULL GASKET SET	WITHOUT OIL SEAL FOR PLASTIC VALVE COVER	74
76119241	OM924	FULL GASKET SET	WITH OIL SEAL FOR PLASTIC VALVE COVER	74
66119241	OM924	FULL GASKET SET	WITHOUT OIL SEAL FOR PLASTIC VALVE COVER	74
76139041	OM904	HEAD GASKET SET	WITH OIL SEAL FOR PLASTIC VALVE COVER	74
76139241	OM904	HEAD GASKET SET	WITH OIL SEAL FOR PLASTIC VALVE COVER	74
76119061	OM906	FULL GASKET SET	WITH OIL SEAL FOR PLASTIC VALVE COVER	76
66119061	OM906	FULL GASKET SET	WITHOUT OIL SEAL FOR PLASTIC VALVE COVER	76
76119261	OM926	FULL GASKET SET	WITH OIL SEAL FOR PLASTIC VALVE COVER	76
66119291	OM926	FULL GASKET SET	WITHOUT OIL SEAL FOR PLASTIC VALVE COVER	76
76136061	OM906	HEAD GASKET SET	WITH OIL SEAL FOR PLASTIC VALVE COVER	76
76139261	OM926	HEAD GASKET SET	WITH OIL SEAL FOR PLASTIC VALVE COVER	76
76114682	OM612	FULL GASKET SET	WITH OIL SEAL WITH REAR OIL SEAL FLANGE	78
76134682	OM612	HEAD GASKET SET	WITH OIL SEAL	78
76112702	OM651	FULL GASKET SET	WITH OIL SEAL	80
76132702	OM651	HEAD GASKET SET	WITH OIL SEAL	80
76114735	OM501(ENGINE 012091 UP TO 084423)	FULL GASKET SET	WITH OIL SEAL WITHOUT O RING	82
76114745	OM501(ENGINE 084424 UP TO 155295)	FULL GASKET SET	WITH OIL SEAL WITHOUT O RING	82
76114715	OM501(ENGINE 155296 UP TO 377748)	FULL GASKET SET	WITH OIL SEAL WITHOUT O RING	82
76114725	OM501(AFTER ENGINE 377749)	FULL GASKET SET	WITH OIL SEAL WITHOUT O RING	82

N° ABR	ENGINE	DESCRIPTION	PAGE
76134735	OM501/502(ENGINE 012091 UP TO 084423)	HEAD GASKET SET WITH OIL SEAL	82
76134745	OM501/502 (ENGINE 084424 UP TO 155295)	HEAD GASKET SET WITH OIL SEAL	82
76134715	OM501/502 (ENGINE 155296 UP TO 377748)	HEAD GASKET SET WITH OIL SEAL	82
76134725	OM501/502 (AFTER ENGINE 377749)	HEAD GASKET SET WITH OIL SEAL	82
76134730	OM501 ALL ENGINES	BOTTOM GASKET SET WITH OIL SEAL WITHOUT OIL PAN GASKET	82
76134720	OM501 (UP TO ENGINE 012090)	BOTTOM GASKET SET WITH OIL SEAL WITH OIL PAN GASKET	82
76134710	OM501 (AFTER ENGINE 012091)	BOTTOM GASKET SET WITH OIL SEAL WITH RUBBER OIL PANS	82
76114755	OM502 (ENGINE 012091 UP TO 084423)	FULL GASKET SET WITH OIL SEALWITHOUT O RING	84
76114765	OM502 (ENGINE 084424 UP TO 155295)	FULL GASKET SET WITH OIL SEALWITHOUT O RING	84
76114775	OM502 (ENGINE 155296 UP TO 377748)	FULL GASKET SET WITH OIL SEALWITHOUT O RING	84
76114785	OM502 (AFTER ENGINE 377749)	FULL GASKET SET WITH OIL SEALWITHOUT O RING	84
76134735	OM501/502 (ENGINE 012091 UP TO 084423)	HEAD GASKET SET WITH OIL SEAL	84
76134745	OM501/502 (ENGINE 084424 UP TO 155295)	HEAD GASKET SET WITH OIL SEAL	84
76134715	OM501/502 (ENGINE 155296 UP TO 377748)	HEAD GASKET SET WITH OIL SEAL	84
76134725	OM501/502 (AFTER ENGINE 377749)	HEAD GASKET SET WITH OIL SEAL	84
76134760	OM502 (ALL)	BOTTOM GASKET SET WITH OIL SEAL WITHOUT OIL PAN GASKET	84
76134750	OM502 (UP TO ENGINE 012090)	BOTTOM GASKET SET WITH OIL SEAL WITH SOFT OIL PAN GASKET	84
76134740	OM502 (AFTER ENGINE 012091)	BOTTOM GASKET SET WITH OIL SEAL WITH OIL RUBBER PAN GASKET	84

MWM

N° ABR	ENGINE	DESCRIPTION	PAGE
64311871	D226	FULL GASKET SET WITHOUT OIL SEAL	88
74311871	D226	FULL GASKET SET WITH OIL SEAL	88
64314181	D229	FULL GASKET SET WITHOUT OIL SEAL	90
74314181	D229	FULL GASKET SET WITH OIL SEAL	90
64414511	D229	FULL GASKET SET WITHOUT OIL SEAL	90
74414511	D229	FULL GASKET SET WITH OIL SEAL	90
64314193	TD229	FULL GASKET SET WITHOUT OIL SEAL	94
74314193	TD229	FULL GASKET SET WITH OIL SEAL	94
64414543	TD229	FULL GASKET SET WITHOUT OIL SEAL	94
74414543	TD229	FULL GASKET SET WITH OIL SEAL	94
64315061	X10	FULL GASKET SET WITHOUT OIL SEAL	98
74315061	X10	FULL GASKET SET WITH OIL SEAL	98
64315071	X10	FULL GASKET SET WITHOUT OIL SEAL	98
74315071	X10	FULL GASKET SET WITH OIL SEAL	98
64315032	4.12TCE X12	FULL GASKET SET WITHOUT OIL SEAL	102
74315032	4.12TCE X12	FULL GASKET SET WITH OIL SEAL	102
64315042	6.12TCE X12	FULL GASKET SET WITHOUT OIL SEAL	102
74315042	6.12TCE X12	FULL GASKET SET WITH OIL SEAL	102
64315083	SPRINT 407	FULL GASKET SET WITHOUT OIL SEAL	106
74315083	SPRINT 407	FULL GASKET SET WITH OIL SEAL	106
74385081	SPRINT 407	FULL GASKET SET WITH OIL SEAL	106
64315103	SPRINT 407	FULL GASKET SET WITHOUT OIL SEAL	106
74315103	SPRINT 407	FULL GASKET SET WITH OIL SEAL	106
74385103	SPRINT 407	FULL GASKET SET WITH OIL SEAL	106
64315093	SPRINT 6.07	FULL GASKET SET WITH OIL SEAL	108
74315093	SPRINT 6.07	FULL GASKET SET WITH OIL SEAL	108
74335093	SPRINT 6.07	FULL GASKET SET WITH OIL SEAL	108
64315093	SPRINT 6.07	FULL GASKET SET WITHOUT OIL SEAL	112
74315093	SPRINT 6.07	HEAD GASKET SET WITH OIL SEAL	112
74335093	SPRINT 6.07	BOTTOM GASKET SET WITH OIL SEAL	112
64315145	MWM MAX FORCE TURBO EURO 5	FULL GASKET SET WITHOUT OIL SEAL	116
74315145	MWM MAX FORCE TURBO EURO 5	FULL GASKET SET WITH OIL SEAL	116
74335145	MWM MAX FORCE TURBO EURO 5	HEAD GASKET SET WITH OIL SEAL	116
64315165	MWM MAX FORCE TURBO EURO 5	FULL GASKET SET WITHOUT OIL SEAL	116
74315165	MWM MAX FORCE TURBO EURO 5	FULL GASKET SET WITH OIL SEAL	116
74335165	MWM MAX FORCE TURBO EURO 5	HEAD GASKET SET WITH OIL SEAL	116
84335465	MWM MAX FORCE TURBO EURO 5	MONOCYLINDER GASKET SET WITH OIL SEAL	116

MAXION PERKINS

Nº ABR	ENGINE	DESCRIPTION		PAGE
70910572	NGD 3.0	FULL GASKET SET	WITH OIL SEAL	122
70930572	NGD 3.0	HEAD GASKET SET	WITH OIL SEAL	122
60910359	3152	FULL GASKET SET	WITH INDIRECT INJECTION WITHOUT OIL SEAL	124
70910359	3152	FULL GASKET SET	WITH INDIRECT INJECTION WITH OIL SEAL	124
70930359	3152	FULL GASKET SET	WITH INDIRECT INJECTION WITH OIL SEAL	124
60910361	D3152	FULL GASKET SET	WITH INDIRECT INJECTION WITHOUT OIL SEAL	124
70910361	D3152	FULL GASKET SET	WITH INDIRECT INJECTION WITH OIL SEAL	124
60930361	D3152	FULL GASKET SET	WITH INDIRECT INJECTION WITHOUT OIL SEAL	124
70910831	4203	FULL GASKET SET	WITH INDIRECT INJECTION WITHOUT OIL SEAL	128
70932931	4203	FULL GASKET SET	WITH INDIRECT INJECTION WITHOUT OIL SEAL	128
60912931	4203	FULL GASKET SET	WITH INDIRECT INJECTION WITHOUT OIL SEAL	128
70912931	4203	FULL GASKET SET	WITH INDIRECT INJECTION WITHOUT OIL SEAL	128
60913001	4203	FULL GASKET SET	WITH INDIRECT INJECTION WITHOUT OIL SEAL	132
70913001	4203	FULL GASKET SET	WITH INDIRECT INJECTION WITHOUT OIL SEAL	132
70932791	4203	HEAD GASKET SET	WITH INDIRECT INJECTION WITHOUT OIL SEAL	132
60912981	D4236/4238	FULL GASKET SET	WITHOUT OIL SEAL	136
70912981	D4236/4238	FULL GASKET SET	WITH OIL SEAL	136
70913981	T4236	FULL GASKET SET	WITH OIL SEAL	136
60913031	T4236	FULL GASKET SET	WITHOUT OIL SEAL	136
60916151	D4236/4248	FULL GASKET SET	WITHOUT OIL SEAL	140
70916151	D4236/4248	FULL GASKET SET	WITH OIL SEAL	140
70916151	4236 / 4248	FULL GASKET SET	WITH OIL SEAL	140
70933031	4236 / 4248	HEAD GASKET SET	WITH OIL SEAL	140
70930051	4236 / 4248	FULL GASKET SET	WITH OIL SEAL	144
60910151	Q20B/4236	FULL GASKET SET	WITHOUT OIL SEAL	144
70910151	Q20B/4236	FULL GASKET SET	WITH OIL SEAL	144
60930051	Q20B/D4236/4248	FULL GASKET SET	WITHOUT OIL SEAL	144
70930051	Q20B/D4236/4248	FULL GASKET SET	WITH OIL SEAL	148
60914763		FULL GASKET SET	WITHOUT OIL SEAL	148
70914763		FULL GASKET SET	WITH OIL SEAL	148
60934763		HEAD GASKET SET	WITHOUT OIL SEAL	148
60914053		FULL GASKET SET	WITHOUT OIL SEAL	148
70914053		FULL GASKET SET	WITH OIL SEAL	148
60934053		HEAD GASKET SET	WITHOUT OIL SEAL	152
60914753	P4000/94000T	FULL GASKET SET	WITHOUT OIL SEAL	152
70914753	P4000/94000T	FULL GASKET SET	WITH OIL SEAL	152
70934751	P4000/94000T	FULL GASKET SET	WITH OIL SEAL	156
60914733	S4/S4T	FULL GASKET SET	WITH OIL SEAL	156
70914733	S4/S4T	FULL GASKET SET	WITH OIL SEAL	156
70934731	S4/S4T	HEAD GASKET SET	WITH OIL SEAL	160
60914773	HS 2.5	FULL GASKET SET	WITHOUT OIL SEAL	160
70914773	HS 2.5	FULL GASKET SET	WITH OIL SEAL	160
60934773	HS 2.5	HEAD GASKET SET	WITHOUT OIL SEAL	160
70934773	HS 2.5	HEAD GASKET SET	WITH OIL SEAL	164
60914873	HS 2.8	FULL GASKET SET	WITH OIL SEAL	164
70914873	HS 2.8	FULL GASKET SET	WITH OIL SEAL	164
60934873	HS 2.8	HEAD GASKET SET	WITH OIL SEAL	164
70934873	HS 2.8	HEAD GASKET SET	WITH OIL SEAL	168
60913761	P6354.4	FULL GASKET SET	WITH OIL SEAL	168
70913761	P6354.4	FULL GASKET SET	WITH OIL SEAL	168
70933761	P6354.4	HEAD GASKET SET	WITH OIL SEAL	168
60913763	P6354.4	FULL GASKET SET	WITHOUT OIL SEAL	172
60913761	P6354.4	FULL GASKET SET	WITHOUT OIL SEAL	172
70913761	P6354.4	FULL GASKET SET	WITH OIL SEAL	172
70933761	P6354.4	FULL GASKET SET	WITH OIL SEAL	172
60913763	P6354.4	HEAD GASKET SET	WITHOUT OIL SEAL	176
60912881	P6357	FULL GASKET SET	WITH OIL SEAL	176
70912881	P6357	FULL GASKET SET	WITH OIL SEAL	176
70932881	P6357	HEAD GASKET SET	WITH OIL SEAL	178
60913439	P6358	FULL GASKET SET	WITHOUT OIL SEAL	178
70913439	P6358	FULL GASKET SET	WITH OIL SEAL	178
70933431	P6358	HEAD GASKET SET	WITH OIL SEAL	178

IVECO

Nº ABR	ENGINE	DESCRIPTION	PAGE
63510101	DUCATO 2.5/2.8	FULL GASKET SET WITHOUT OIL SEAL	186
73510101	DUCATO 2.5/2.8	FULL GASKET SET WITHOUT OIL SEAL	186
63510121	DUCATO 2.5/2.8	FULL GASKET SET WITHOUT OIL SEAL	186
73510121	DUCATO 2.5/2.8	FULL GASKET SET WITHOUT OIL SEAL	186
73530101	DUCATO 2.5/2.8	HEAD GASKET SET WITHOUT OIL SEAL	186
73510131	DUCATO 2.8	FULL GASKET SET WITH INDIRECT INJECTION WITH OIL SEAL	190
63540131	DUCATO 2.8	HEAD GASKET SET WITH INDIRECT INJECTION WITHOUT OIL SEAL	190
73540131	DUCATO 2.8	HEAD GASKET SET WITH INDIRECT INJECTION WITHOUT OIL SEAL	190
73530101	DUCATO 2.5/2.8	HEAD GASKET SET WITH DIRECT INJECTION WITHOUT OIL SEAL	190
73510162	JTD 2.3	FULL GASKET SET WITH OIL SEAL	194
73530162	JTD 2.3	HEAD GASKET SET WITH OIL SEAL	194
73510182	FICE0481D	FULL GASKET SET WITH OIL SEAL	196
73530182	FICE0481D	HEAD GASKET SET WITH OIL SEAL	196
73510202	CURSOR 8	FULL GASKET SET WITH OIL SEAL	198
73530202	CURSOR 8	HEAD GASKET SET WITH OIL SEAL	198
73510252	CURSOR 9	FULL GASKET SET WITH OIL SEAL	200
73530252	CURSOR 9	HEAD GASKET SET WITH OIL SEAL	200
73510352	CURSOR 10	FULL GASKET SET WITH OIL SEAL	202
73530352	CURSOR 10	HEAD GASKET SET WITH OIL SEAL	202
73510302	CURSOR 13	FULL GASKET SET WITH OIL SEAL	204
73530302	CURSOR 13	HEAD GASKET SET WITH OIL SEAL	204

SCANIA

Nº ABR	ENGINE	DESCRIPTION	PAGE
73716300	DN11/DS11	FULL GASKET SET WITH OIL SEAL WITH LINER RINGS	208
63714745	DN11/DS11	FULL GASKET SET WITHOUT OIL SEAL WITHOUT LINER RINGS	208
73714745 L111/112	DN11/DS11	FULL GASKET SET WITH OIL SEAL WITH LINER RINGS	208
63734745	DN11/DS11	HEAD GASKET SET WITHOUT OIL SEAL WITHOUT LINER RINGS	208
73796310	DS11/DSC11	FULL GASKET SET WITHOUT OIL SEAL WITHOUT LINER RINGS	212
63796315	DS11/DSC11	FULL GASKET SET WITH OIL SEAL WITHOUT LINER RINGS	212
73796315	DS11/DSC11	HEAD GASKET SET WITH OIL SEAL WITH LINER RINGS	212
63736345	DS11/DSC11	HEAD GASKET SET WITHOUT OIL SEAL WITHOUT LINER RINGS	212
73710430	DN11/DS11/DSC11	FULL GASKET SET WITH OIL SEAL WITH LINER RINGS	216
63710435	DN11/DS11/DSC11	FULL GASKET SET WITHOUT OIL SEAL WITHOUT LINER RINGS	216
73710435	DN11/DS11/DSC11	FULL GASKET SET WITH OIL SEAL WITHOUT LINER RINGS	220
63730435	DN11/DS11/DSC11	HEAD GASKET SET WITHOUT OIL SEAL WITHOUT LINER RINGS	220
63710129	DC11	FULL GASKET SET WITHOUT OIL SEAL WITH LINER RINGS	224
73710129	DC11	FULL GASKET SET WITH OIL SEAL WITH LINER RINGS	224
63710429	DSC12	FULL GASKET SET WITHOUT OIL SEAL WITH LINER RINGS	224
73710429	DSC12	FULL GASKET SET WITH OIL SEAL WITH LINER RINGS	224
63710109	DSC12	FULL GASKET SET WITHOUT OIL SEAL WITH LINER RINGS	224
73710109	DSC12	FULL GASKET SET WITH OIL SEAL WITH LINER RINGS	224
63730121	DC11	MONOCYLINDER GASKET SET WITHOUT OIL SEAL WITHOUT LINER RINGS	228
73730121	DC11	MONOCYLINDER GASKET SET WITH OIL SEAL WITHOUT LINER RINGS	228
63730421	DSC12	MONOCYLINDER GASKET SET WITHOUT OIL SEAL WITHOUT LINER RINGS	228
73730421	DSC12	MONOCYLINDER GASKET SET WITH OIL SEAL WITHOUT LINER RINGS	228
63730101	DSC12	MONOCYLINDER GASKET SET WITHOUT OIL SEAL WITHOUT LINER RINGS	228
73730101	DSC12	MONOCYLINDER GASKET SET WITH OIL SEAL WITHOUT LINER RINGS	228
73712535	DS14/LK140/LK141	FULL GASKET SET WITH OIL SEAL WITHOUT LINER RINGS	230
63732535	DS14/LK140/LK141	MONOCYLINDER GASKET SET WITHOUT OIL SEAL WITHOUT LINER RINGS	230

JOHN DEERE

Nº ABR	ENGINE	DESCRIPTION	PAGE
60210401	3029D	FULL GASKET SET WITHOUT OIL SEAL	234
60230401	3029D	HEAD GASKET SET WITHOUT OIL SEAL	234
60210301	4045T	FULL GASKET SET WITHOUT OIL SEAL	236
70210301	4045T	FULL GASKET SET WITH OIL SEAL	236
60230301	4045T	HEAD GASKET SET WITHOUT OIL SEAL	236
60210201	6068D	FULL GASKET SET WITHOUT OIL SEAL	238
70210201	6068D	FULL GASKET SET WITH OIL SEAL	238
60230201	6068D	HEAD GASKET SET WITHOUT OIL SEAL	238
60210501	6090T	FULL GASKET SET WITHOUT OIL SEAL	240
60230501	6090T	HEAD GASKET SET WITHOUT OIL SEAL	240

FORD

N° ABR	ENGINE	DESCRIPTION	PAGE
64113401	4630	FULL GASKET SET WITHOUT OIL SEAL	244
74113401	4630	FULL GASKET SET WITH OIL SEAL	244
64133401	4630	HEAD GASKET SET WITHOUT OIL SEAL	244
74133401	4630	HEAD GASKET SET WITH OIL SEAL	244
64113301	4600/4610/4810	FULL GASKET SET WITHOUT OIL SEAL	248
74113301	4600/4610/4810	FULL GASKET SET WITH OIL SEAL	248
64133301	4600/4610/4810	HEAD GASKET SET WITHOUT OIL SEAL	248
74133301	4600/4610/4810	HEAD GASKET SET WITH OIL SEAL	248
64113601	F4000/6600/7610	FULL GASKET SET WITHOUT OIL SEAL	252
74113601	F4000/6600/7610	FULL GASKET SET WITH OIL SEAL	252
64133601	F4000/6600/7610	HEAD GASKET SET WITHOUT OIL SEAL	252
64114361	F4000/6600/7610	FULL GASKET SET WITHOUT OIL SEAL	252
64114361	F4000/5610/6600/6610	FULL GASKET SET WITHOUT OIL SEAL	256
64113181	F4000/5610/6600/6610	FULL GASKET SET WITH OIL SEAL	256
74113181	F4000/5610/6600/6610	FULL GASKET SET WITHOUT OIL SEAL	256
64133181	F4000/5610/6600/6610	HEAD GASKET SET WITHOUT OIL SEAL	256
64113651	7630	FULL GASKET SET WITHOUT OIL SEAL	260
74113651	7630	FULL GASKET SET WITH OIL SEAL	260
64133651	7630	FULL GASKET SET WITHOUT OIL SEAL	260
64113501	5030/5630/6630	FULL GASKET SET WITHOUT OIL SEAL	260
74113501	5030/5630/6630	FULL GASKET SET WITH OIL SEAL	260
64133501	7630	FULL GASKET SET WITHOUT OIL SEAL	260
64111093	7830/8030	FULL GASKET SET WITHOUT OIL SEAL	264
74111093	7830/8030	FULL GASKET SET WITH OIL SEAL	264
64133091	7830/8030	HEAD GASKET SET WITHOUT OIL SEAL	264
64111081	PHASE 1	FULL GASKET SET WITHOUT OIL SEAL	266
74111081	PHASE 1	HEAD GASKET SET WITH OIL SEAL	266
64131081	PHASE 1	HEAD GASKET SET WITHOUT OIL SEAL	266
64131061	PHASE 2	HEAD GASKET SET WITHOUT OIL SEAL	266
64111061	PHASE 2	FULL GASKET SET WITHOUT OIL SEAL	266
74111061	PHASE 2	FULL GASKET SET WITH OIL SEAL	266
64115132	TRANSIT 2.4 TDCI	FULL GASKET SET WITHOUT OIL SEAL	270
74115132	TRANSIT 2.4 TDCI	FULL GASKET SET WITH OIL SEAL	270
64135132	TRANSIT 2.4 TDCI	HEAD GASKET SET WITHOUT OIL SEAL	270
74135132	TRANSIT 2.4 TDCI	HEAD GASKET SET WITH OIL SEAL	270
64115142	OUMA 3.2 TDCI	FULL GASKET SET WITHOUT OIL SEAL	272
74115142	OUMA 3.2 TDCI	FULL GASKET SET WITH OIL SEAL	272
64135142	OUMA 3.2 TDCI	HEAD GASKET SET WITHOUT OIL SEAL	272
74135142	OUMA 3.2 TDCI	HEAD GASKET SET WITH OIL SEAL	272
74115282	TRANSIT 2.2	FULL GASKET SET WITH OIL SEAL	274
74118282	TRANSIT 2.2	FULL GASKET SET WITH OIL SEAL	274

VALTRA

N° ABR	ENGINE	DESCRIPTION		PAGE
64410121	420 DS	FULL GASKET SET	WITHOUT OIL SEAL	278
64410141	420 DS	FULL GASKET SET	WITHOUT OIL SEAL	278
64430121	420 DS	HEAD GASKET SET	WITHOUT OIL SEAL	278
74410121	420 DS	FULL GASKET SET	WITH OIL SEAL	278
74410141	420 DS	FULL GASKET SET	WITH OIL SEAL	278
64410131	620 DS	FULL GASKET SET	WITHOUT OIL SEAL	282
64410151	620 DS	FULL GASKET SET	WITHOUT OIL SEAL	282
64430131	620 DS	HEAD GASKET SET	WITHOUT OIL SEAL	282
64410161	620 DS	FULL GASKET SET	WITHOUT OIL SEAL	282
64430161	620 DS	HEAD GASKET SET	WITHOUT OIL SEAL	282
74410161	620 DS	HEAD GASKET SET	WITH OIL SEAL	282

NEW RELEASES

N° ABR	ENGINE	DESCRIPTION		PAGE
74012532	2.8LITER 16 VALVE	FULL GASKET SET	WITH OIL SEAL	284
74032532	2.8LITER 16 VALVE	HEAD GASKET SET	WITH OIL SEAL	284

LEGENDS AND SPECIFICATIONS

MATERIAL CODE	MATERIAL	DESCRIPTION - CYLINDER HEAD GASET
00	HTM-S	HIGH TORQUE RETENTION MATERIAL - SOLID
01	HTM-P	HIGH TORQUE RETENTION MATERIAL - PERFORATED
02	ML	MULTI - LAYER
03	HTM-PT	HIGH TORQUE RETENTION MATERIAL - PERFORATED TURBO
04	HTM-P	HIGH TORQUE RETENTION MATERIAL - PERFORATED
05	HTM-ME	HTM - METAL - RUBBER ELASTOMER
MATERIAL CODE	MATERIAL	DESCRIPTION - CYLINDER HEAD GASET
16	HTM-P	HIGH TORQUE RETENTION MATERIAL - PERFORATED
17 OU 18	FF	STEEL SHEET / PH / STEEL SHEET
19	LT	BRASS
20 / 24	CU	COPPER
25 / 29	AL	ALUMINUM
30 / 39	AC	RUBBER WITH STEEL AND METAL
31		WOLVERINE
40 / 45	BO	RUBBER
47	HTM-P	HIGH TORQUE RETENTION MATERIAL - PERFORATED

CÓDIGO DO MATERIAL	MATERIAL	DESCRIPTION - GASKETS DIVERSAS
48	GX	GASKET
49	RT	OIL SEAL
50 / 58	CE	RUBBER AND CORK
59	CL	RUBBER CORK WITH CANVAS
60 / 64	FI	FIBERS
65	FE	FILTER
66	PVC	PVC
67	PH	HYDRAULIC CARDBOARD
68	BQT	PH COATED BAKELITE
70 / 73	PP	PRESBAN
75	PK	KRAFT PAPER
77	PH	ALTERNATIVE HYDRAULIC CARDBOARD
80 / 89	GA	GUARNITAL
90 / 99	PH	HYDRAULIC CARDBOARD

THE IDENTIFICATION CODE OF PARTS MANUFACTURED BY ABR IS COMPOSED OF THE NUMBER ACCORDING TO THE EXAMPLES BELOW :

1) IN THE CASE OF SINGLE GASKETS: FIRE CRANKCASE GASKET 5 . 73 . 856 . 40

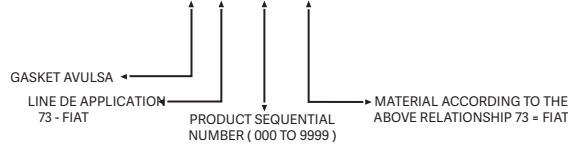

2) IN CASE OF GASKETS: FIAT FIRE COMPLETE SET 1.0/1.3 8 VALVES 6 . 73 . 1 605 . 1

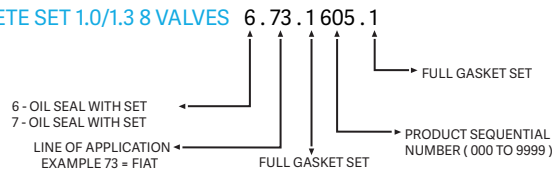

ADDITIONAL INFORMATION ON GASKET GAMES IDENTIFICATION CODES:

1 DIGIT	6 - INDICATES MISCELLANEOUS SET WITHOUT OIL SEAL / PARTIALS
	7 - INDICATE SET WITH OIL SEAL / PARTIALS
	8 - INDICATE MISCELLANEOUS SET : OIL PAN, EXCAHANGE, TURBO, ...
4 DIGIT	1 - INDICATE COMLETE SET
	3 - INDICATE / BOTTOM SET
8 DIGIT	1 OR 3 - INDICATE FULL / HEAD SET
	0 - INDICATE BOTTOM SET

ALL NAMES AND LOGOMARKS OF THIRD PARTIES PRESENTED IN THIS CATALOG ARE THE PROPERTY OF THEIR RESPECTIVE COMPANIES. ALL RIGHTS RESERVED.
THIS CATALOG MAY NOT BE REPRODUCED, ARCHIVED OR USED, NOR COPIED BY ANY MEANS, ELECTRONIC, PRINTED, PHOTOCOPIED, ENGRAVED, REWORKED OR ANY OTHER MEANS WITHOUT PRIOR PERMISSION OF ABR INDÚSTRIA E COMÉRCIO DE AUTO PEÇAS LTDA. ALL INFORMATION CONTAINED IN THIS CATALOG WAS EXTRACTED FROM SECURE SOURCES. DESPITE ALL OUR. DESPITE ALL OUR EFFORT TO PREPARE A HIGHLY RELIABLE CATALOG, WE CANNOT GUARANTEE COMPLETE ACCURACY OF THE INFORMATION, AND AS A RESULT, WE ARE NOT RESPONSIBLE FOR ANY ERRORS, OMISSIONS, OR DAMAGE OR LOSS THAT MAY OCCUR.

The image shows the Cummins logo, which consists of two parallel blue diagonal lines followed by the word "CUMMINS" in a bold, blue, sans-serif font. The logo is centered horizontally and vertically within a white rectangular frame defined by blue lines.

//CUMMINS

CUMMINS

N° ABR	ENGINE	DESCRIPTION		PAGE
68313943	4B/4BT	FULL GASKET SET	WITHOUT OIL SEAL	18
78313943	4B/4BT	FULL GASKET SET	WITH OIL SEAL	18
68333941	4B/4BT	HEAD GASKET SET	WITHOUT OIL SEAL	18
78333941	4B/4BT	HEAD GASKET SET	WITH OIL SEAL	18
68333940	4B/4BT	BOTTOM GASKET SET	WITHOUT OIL SEAL	18
78333940	4B/4BT	BOTTOM GASKET SET	WITH OIL SEAL	18
78310643	ISBe4 3.9L	FULL GASKET SET	WITH OIL SEAL	20
78330641	ISBe4 3.9L	HEAD GASKET SET	WITH OIL SEAL	20
78330640	ISBe4 3.9L	BOTTOM GASKET SET	WITH OIL SEAL	20
78310648	ISBe4 3.9L	FULL GASKET SET	WITH OIL SEAL WITHOUT JET COOLER	20
78330648	ISBe4 3.9L	HEAD GASKET SET	WITH OIL SEAL WITHOUT JET COOLER	20
68315943	6B/6BT	FULL GASKET SET	WITHOUT OIL SEAL	22
78315943	6B/6BT	FULL GASKET SET	WITH OIL SEAL	22
68335941	6B/6BT	HEAD GASKET SET	WITHOUT OIL SEAL	22
78335941	6B/6BT	HEAD GASKET SET	WITH OIL SEAL	22
68335940	6B/6BT	BOTTOM GASKET SET	WITHOUT OIL SEAL	22
78335940	6B/6BT	BOTTOM GASKET SET	WITH OIL SEAL	24
68310663	ISBe6 5.9L	FULL GASKET SET	WITHOUT OIL SEAL	24
78310663	ISBe6 5.9L	FULL GASKET SET	WITH OIL SEAL	24
68330661	ISBe6 5.9L	HEAD GASKET SET	WITHOUT OIL SEAL	24
78330661	ISBe6 5.9L	HEAD GASKET SET	WITH OIL SEAL	24
68330660	ISBe6 5.9L	BOTTOM GASKET SET	WITHOUT OIL SEAL	24
78330660	ISBe6 5.9L	BOTTOM GASKET SET	WITH OIL SEAL	24
78310668	ISBe6 5.9L	FULL GASKET SET	WITH OIL SEAL WITHOUT JET COOLER	24
68314943	6C/6CTA	FULL GASKET SET	WITHOUT OIL SEAL	26
78314943	6C/6CTA	FULL GASKET SET	WITH OIL SEAL	26
68334941	6C/6CTA	HEAD GASKET SET	WITHOUT OIL SEAL	26
78334941	6C/6CTA	HEAD GASKET SET	WITH OIL SEAL	26
68334940	6C/6CTA	BOTTOM GASKET SET	WITHOUT OIL SEAL	26
78334940	6C/6CTA	BOTTOM GASKET SET	WITH OIL SEAL	26
78314949	6C/6CTA	FULL GASKET SET	WITH OIL SEAL WITH O RINGS	26
78334949	6C/6CTA	BOTTOM GASKET SET	WITH OIL SEAL WITH O RINGS	26
68310593	ISC 8.3L/ ISL 8.9L	FULL GASKET SET	WITHOUT OIL SEAL	30
78310593	ISC 8.3L/ ISL 8.9L	FULL GASKET SET	WITH OIL SEAL	30
68330591	ISC 8.3L/ ISL 8.9L	HEAD GASKET SET	WITHOUT OIL SEAL	30
78330591	ISC 8.3L/ ISL 8.9L	HEAD GASKET SET	WITH OIL SEAL	30
68330590	ISC 8.3L/ ISL 8.9L	BOTTOM GASKET SET	WITHOUT OIL SEAL	30
78330590	ISC 8.3L/ ISL 8.9L	BOTTOM GASKET SET	WITH OIL SEAL	30
68310772	ISB4.5 / QSB4.5	FULL GASKET SET	WITHOUT OIL SEAL	32
78310772	ISB4.5 / QSB4.5	FULL GASKET SET	WITH OIL SEAL	32
68330771	ISB4.5 / QSB4.5	HEAD GASKET SET	WITHOUT OIL SEAL	32
78330771	ISB4.5 / QSB4.5	HEAD GASKET SET	WITH OIL SEAL	32
68330770	ISB4.5 / QSB4.5	BOTTOM GASKET SET	WITHOUT OIL SEAL	32
78330770	ISB4.5 / QSB4.5	BOTTOM GASKET SET	WITH OIL SEAL	32
68310752	ISB6.7/QSB6.7	FULL GASKET SET	WITHOUT OIL SEAL	32
78310778	ISB4.5 / QSB4.5	FULL GASKET SET	WITH OIL SEAL WITHOUT JET COOLER	32
78330778	ISB4.5 / QSB4.5	BOTTOM GASKET SET	WITH OIL SEAL WITHOUT JET COOLER	32
78310752	ISB6.7/QSB6.7	FULL GASKET SET	WITH OIL SEAL	34
68330751	ISB6.7/QSB6.7	HEAD GASKET SET	WITHOUT OIL SEAL	34
78330751	ISB6.7/QSB6.7	HEAD GASKET SET	WITH OIL SEAL	34
68330750	ISB6.7/QSB6.7	BOTTOM GASKET SET	WITHOUT OIL SEAL	34
78330750	ISB6.7/QSB6.7	BOTTOM GASKET SET	WITH OIL SEAL	34
78310758	ISB6.7/QSB6.7	FULL GASKET SET	WITH OIL SEAL WITHOUT JET COOLER	34
78330758	ISB6.7/QSB6.7	BOTTOM GASKET SET	WITH OIL SEAL WITHOUT JET COOLER	34
78310732	ISF 4 CYLINDERS.3.8L	FULL GASKET SET	WITH OIL SEAL	36
78330732	ISF 4 CYLINDERS.3.8L	HEAD GASKET SET	WITH OIL SEAL	36
78330730	ISF 4 CYLINDERS.3.8L	BOTTOM GASKET SET	WITH OIL SEAL	36
78310712	ISF 4 CYLINDERS.2.8L	FULL GASKET SET	WITH OIL SEAL	38
78330712	ISF 4 CYLINDERS.2.8L	HEAD GASKET SET	WITH OIL SEAL	38
78330710	ISF 4 CYLINDERS.2.8L	BOTTOM GASKET SET	WITH OIL SEAL	38

/// ABBR

CUMMINS 4B/4BT 4 CYLINDERS 3.9LITER 8VALVES (EURO 2)

N° SET		DESCRIPTION				
68313943		FULL GASKET SET CUMMINS 4B / 4BT WITHOUT OIL SEAL				1
78313943		FULL GASKET SET CUMMINS 4B / 4BT WITH OIL SEAL				2
68333941		HEAD GASKET SET CUMMINS 4B / 4BT WITHOUT OIL SEAL				3
78333941		HEAD GASKET SET CUMMINS 4B / 4BT WITH OIL SEAL				4
68333940		BOTTOM GASKET SET CUMMINS 4B / 4BT WITHOUT OIL SEAL				5
78333940		BOTTOM GASKET SET CUMMINS 4B / 4BT WITH OIL SEAL				6
N° ABR	N° CUMMINS	DESCRIPTION				
58312601	3283569	CYLINDER HEAD GASKET Ø106MM	1	1	1	1
58311343	3902660	VALVE COVER GASKET	4	4	4	4
58310431	3927154	EXHAUST MANIFOLD GASKET	4	4	4	4
58313067	3938153	INTAKE MANIFOLD GASKET	1	1	1	1
58312967	3938162	OIL PAN GASKET	1	1	1	1
58309516	3914385	DISTRIBUTION COVER GASKET	1	1	1	1
RE05287T	3909410	REAR OIL SEAL 130X150X14MM	1		1	
RE07647T	3904353	FRONT OIL SEAL 63,5X79,5X8MM	1		1	
RE09006S	3921640	VALVE STEM SEAL 7,5X12X12MM		8	8	
56121231	3901356	TURBOCHARGING GASKET	1	1	1	1
58303790	3931350	OIL DRAINAGE PIPE GASKET	1	1	1	1
58303850	3908096	PLATE COVER GASKET	1	1	1	1
58304616	3939258	FUEL PUMP GASKET	1	1	1	1
58307016	3931348	TERMOSTATS GASKET				
58308066	3930120	STOM COOLING NOZZLE	4	4	4	4
58308390	3931607	INJECTION PUMP GASKET	1	1	1	1
58309616	3942914	COOLER COVER GASKET	1	1	1	1
58309767	3938159	REAR COVER GASKET	1	1	1	1
58309867	3938156	GEAR COVER HOUSING GASKET	1	1	1	1
58310266	3930139	STOM COOLING NOZZLE	4	4	4	4
58310616	154916	HYDRAULIC PUMP GASKET	1	1	1	1
58310767	3938157	OIL PUMP GASKET	1	1	1	1
58310816	3931349	OIL PUMP GASKET	1	1	1	1
58310916	3008400	OIL PUMP GASKET	1	1	1	1
58311632	3912220	OUTLET CONNECTION EXHAUST GASKET		1	1	1
58312432	3354864	TURBINE RING	2	2	2	2
58314516	3929792	OIL FILTER CYLINDER HEAD GASKET	1	1	1	1
58314640	3283767	SIDE COVER GASKET	1	1	1	1
58317416	3920336	THERMOSTATS VALVE GASKET		1	1	1
58318467	3937604	EXHAUST COLLECTOR GASKET		2	2	2
88310546		HEAD KIT RUBBERS		1	1	1
88310726		BOTTOM KIT WASHERS	1	1	1	1
88310746		BOTTOM KIT RUBBERS	1	1	1	1
88319126		HEAD KIT WASHERS		1	1	1

• SOLD SEPARATELY

APPLICATION

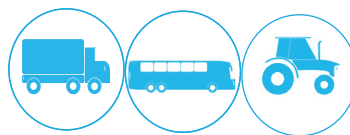

FORD CARGO 814 1996/01 815/815S 2001/05 F250/F350 1998/05 F4000 1996/05

CASE 580H 1994/...

FIAT-ALLIS RETRO FB80.4 / FB100.4

CUMMINS 4B/4BT 4 CYLINDERS 3.9LITER 8VALVES (EURO 2)

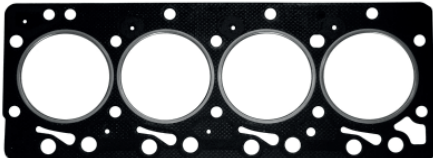

58312601 - THCKNESS 106 MM

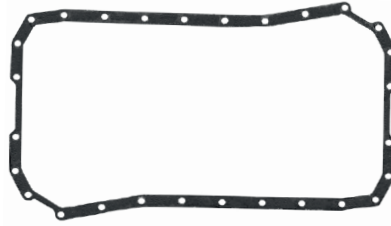

58312967

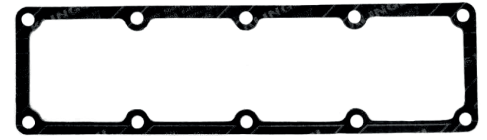

58313067



58314640

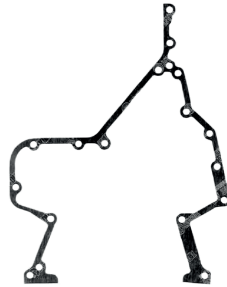

58309867

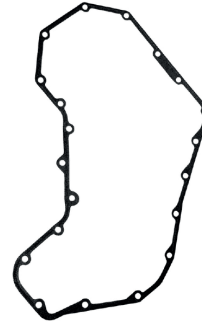

58309547



58311343



58318567



58310431

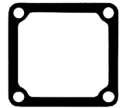

58318467



58317416



58308390



58310616



58310916



58310847



58310767



58309767

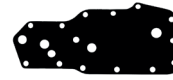

58314516

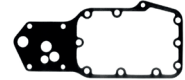

58309616



56121231



58303790



58308066



58304616



58312432

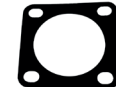

58311632



58303850



RE07647T



RE05287T

1. ARRUELA DE COBRE
RE09006S



58307016



58310266

88310726 BOTTOM KIT WASHERS		
N° ABR	DESCRIPTION	QTD
50072424	COPPER WASHER 22,5 X 26,7 X 1,50MM	2
50025124	COPPER WASHER 18,2X 23,5 X 1,5MM	4

88310746 BOTTOM KIT RUBBERS		
N° ABR	DESCRIPTION	QTD
50037341	RING 15,0X2,50MM	1
54355544	O RING 74,0X85,0X9,8X10,2MM	1
58311140	O RING 98,7X88,1X5,2MM	1
58307741	O RING 29,7X33,8X2,0MM	1
58312140	O RING 25,0X28,0X1,6MM	1
58311240	O RING 60,7X50,1X5,2MM	1
58312240	O RING 44,5X41,0X2,5MM	1
58316440	OIL SEAL 122,6X119,3X2,6MM	1
	O RING 157,10X163,10X7,1MM	1

88310546 HEAD KIT RUBBERS		
N° ABR	DESCRIPTION	QTD
58315240	O RING 50,0X59,25X16,25MM	1
58315140	O RING 9,75X19,0X8,6MM	4
50033541	OIL SEAL 9,0 X 1,90MM	4
58311840	O RING 48,0X30,0X3,0MM	1
58311940	O RING 72,9X69,5X1,7MM	1

88319126 HEAD KIT WASHERS		
N° ABR	DESCRIPTION	QTD
	STEEL WASHER 9,5 X 20,0 X 2,0MM	4
50072424	COPPER WASHER 22,5 X 27,2 X 1,50MM	2
50072429	ALUMINUM WASHER 22,5 X 26,7 X 1,5MM	1
58309224	COPPER WASHER 6,3X10X1,0MM (PAIR)	4
50011024	COPPER WASHER 7,3X15,0X2,0MM	4
50011020	COPPER WASHER 7,3X15,0X1,0MM	4
	COPPER WASHER 9,6 X 16,0 X 1,5MM	4

CUMMINS ISBe4 3.9L 16V ELETRONICO (EURO 3)

N° SET		DESCRIPTION			
78310643		FULL GASKET SET CUMMINS ISBe4 WITH OIL SEAL			1
78330641		HEAD GASKET SET CUMMINS ISBe4 WITH OIL SEAL			2
78330640		BOTTOM GASKET SET CUMMINS ISBe4 WITH OIL SEAL			3
78310648		FULL GASKET SET CUMMINS ISBe4 WITH OIL SEAL WITHOUT JET COOLER			4
78330648		HEAD GASKET SET CUMMINS ISBe4 WITH OIL SEAL WITHOUT JET COOLER			5
N° ABR	N° CUMMINS	DESCRIPTION			
58328902	2830706	CYLINDER HEAD GASKET Ø107,5MM 1.25 MM	1	1	1
58328904	2830707	CYLINDER HEAD GASKET Ø107,5MM 1.15 MM			
58329340	4899228	VALVE COVER GASKET	1	1	1
58325431	3955339	EXHAUST MANIFOLD GASKET	4	4	4
58327940	4897877	OIL PAN GASKET	1	1	1
RE08428T	4890833	REAR OIL SEAL 130X155X14MM	1	1	1
RE08427T	4890832	FRONT OIL SEAL 70X100X12,5/16MM	1	1	1
RE08429V	3955393	VALVE STEM SEAL 6,25X12,6X14MM	16	16	16
50951490	36832135	OIL DRAINAGE PIPE GASKET	1	1	1
58328030	4898301	OIL SUCTION CONNECTION GASKET	1	1	1
58328130	4890024	STOM COOLING NOZZLE	4	4	4
58328247	4895742	OIL COOLER GASKET	1	1	1
58328347	4896409	OIL FILTER GASKET	1	1	1
58328431	48 96897	HYDRAULIC PUMP GASKET	1	1	1
58328832	3919369	TURBOCHARGING GASKET	1	1	1
58329132	3932475	TURBOCHARGING GASKET	1	1	1
58329440	4899230	BOTTOM COVER VALVE GASKET	1	1	1
88321346		BOTTOM KIT RUBBERS	1	1	1
88321446		HEAD KIT RUBBERS	1	1	1
88321726		HEAD KIT WASHERS	1	1	1

• SOLD SEPARATELY

APPLICATION

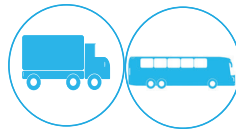

AGRALE MA 12.0 2006/12
FORD 712E 2007/12 F350/815E/1317E/1517E/1717E/1722E/2422E/2622E 2005/2012 F4000 2005/12 F4 MILHA 2009/12 F250 2006/12
VOLKSWAGEN 8150/13170/15170 2003/06 DELIVERY 8150 PLUS/9150 2005/12 9150 2007/...

CUMMINS ISBe4 3.9L 16V ELETRONICO (EURO 3)



58328902 - THCKNESS 1,25 MM

58328904 - THCKNESS 1,15 MM



58327940



58329340



58329440



58328130



58328030



58325431



50951490



58328467



58328832



58329132



RE08427T



RE08428T



58328347



58328247



RE08429V

88321346 BOTTOM KIT RUBBERS		
N° ABR	DESCRIPTION	QTD
	OIL SEAL 12,30 X 2,40MM	1
	OIL SEAL 56,74 X 3,50MM	1
	OIL SEAL 62,00 X 1,50MM	1
	OIL SEAL 24,00 X 2,50MM	1
	OIL SEAL 21,89 X 2,65MM	1
	OIL SEAL 20,35 X 1,78MM	1
	OIL SEAL 30,00 X 2,50MM	1
	OIL SEAL 29,74 X 3,50MM	1
	OIL SEAL 14,00 X 2,50MM	1
	OIL SEAL 25,50 X 2,50MM	1

88321726 HEAD KIT WASHERS		
N° ABR	DESCRIPTION	QTD
	ALUMINUM WASHER 12 X 18 X 1,50MM	2
	ALUMINUM WASHER 14 X 24 X 1,50MM	2
	COPPER WASHER 12 X 16 X 1,50MM	2

88321446 HEAD KIT RUBBERS		
N° ABR	DESCRIPTION	QTD
	OIL SEAL 13,30 X 2,40MM	2
	OIL SEAL 17,00 X 3,00MM	2
	OIL SEAL 85,00 X 2,50MM	1
	OIL SEAL 11,50 X 3,00MM	6
	OIL SEAL 54,00 X 4,00MM	1
	OIL SEAL 88,27 X 98,6 X 5,20MM	1
	OIL SEAL 105,00 X 111,60 X 3,50MM	1
	OIL SEAL 21,00 X 2,50MM	1
	OIL SEAL 14,10 X 20,10 X 3,00MM	2
	OIL SEAL 15,50 X 18,20 X 2,80MM	1
	OIL SEAL 8,00 X 2,40MM	12
	OIL SEAL 9,80 X 1,90MM	2
	OIL SEAL 21,30 X 3,00MM	6
	OIL SEAL 25,00 X 2,50MM	3

CUMMINS 6B/6BT 6 CYLINDERS 5.9L 12V (EURO 2)

N° SET	DESCRIPTION
68315943	FULL GASKET SET CUMMINS 6B/6BT WITHOUT OIL SEAL
78315943	FULL GASKET SET CUMMINS 6B/6BT WITH OIL SEAL
68335941	HEAD GASKET SET CUMMINS 6B/6BT WITHOUT OIL SEAL
78335941	HEAD GASKET SET CUMMINS 6B/6BT WITH OIL SEAL
68335940	BOTTOM GASKET SET CUMMINS 6B/6BT WITHOUT OIL SEAL
78335940	BOTTOM GASKET SET CUMMINS 6B/6BT WITH OIL SEAL

N° ABR	N° CUMMINS	DESCRIPTION	6	5	4	3	2	1
58310501	3283570	CYLINDER HEAD GASKET Ø106MM				1	1	1
58311343	3902666	VALVE COVER GASKET				6	6	6
58310431	3927154	EXHAUST COLLECTOR GASKET				6	6	6
58310067	3931347	EXHAUST COLLECTOR GASKET				1	1	1
58307290	3931346	OIL PAN GASKET	1	1				1
58309416	3918673	DISTRIBUTION COVER GASKET WITH INJECTION PUMP	1	1				1
58309516	3914385	DISTRIBUTION COVER GASKET	1	1				1
RE05287T	3909410	REAR OIL SEAL 130X150X14MM	1					1
RE07647T	3904353	FRONT OIL SEAL 63,5X79,5X8MM	1					1
RE09006S	3921640	VALVE STEM SEAL 7,5X12X12MM				12		12
56121231	3901356	TUBOCHARGING GASKET				1	1	1
58303790	3931350	OIL DRAINAGE PIPE GASKET				1	1	1
58303850	3908096	PLATE COVER GASKET	1	1				1
58304616	3939258	FUEL PUMP GASKET	1	1				1
58307016	3931348	THERMOSTATS GASKET	1	1				1
58308066	3901020	STOM COOLING NOZZLE	6	6				6
58308390	3931607	INJECTION PUMP GASKET	1	1				1
58309616	3942914	COOLER COVER GASKET	1	1				1
58309767	3928493	REAR COVER GASKET	1	1				1
58309867	3916131	GEAR COVER HOUSING GASKET	1	1				1
58310266	3930139	STOM COOLING NOZZLE	6	6				6
58310616	154916	HYDRAULIC PUMP GASKET	1	1				1
58310767	3914383	OIL PUMP GASKET	1	1				1
58310847	3931349	OIL PUMP GASKET	1	1				1
58310916	3008400	COMPRESSOR GASKET	1	1				1
58311016	3942915	FILTER GASKET	1	1				1
58311632	3912220	OUTLET CONNECTION EXHAUST GASKET				1	1	1
58312432	3354864	TURBINE RING				2	2	2
58314516	3929792	OIL FILTER GASKET	1	1				1
58315040	3928832	SIDE COVER GASKET	1	1				1
58317447	3920336	THERMOSTATS VALVE GASKET				1	1	1
58318467	3931604	EXHAUST COLLECTOR GASKET				1	1	2
58318567		OIL DRAINAGE PIPE GASKET				1	1	1
88310846		HEAD KIT RUBBERS				1	1	1
88310946		BOTTOM KIT RUBBERS	1	1				1
88319226		HEAD KIT WASHERS				1	1	1
88310926		BOTTOM KIT WASHERS	1	1				1

• SOLD SEPARATELY

APPLICATION

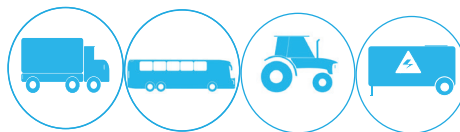

VOLKSWAGEN 12170BT/14170BT 1997/00 16200 1997/03 13170/15170 2000/02 17170 2000/03
13190/15190/15210/23210 2002/05 16170BT 1994/99 16200 1998/00 17210 2000/06
FORD C-1215 1992/01 C-1217 2001/02 C-1415 1992/00 C-1417 2001/02 C-1421 2000/02 C-1517
1992/05 C-1521 2003/06 C-1617 2000/02 C-1621 2000/02 C-1717 2003/05 C-2421 2004/05 F12000 1992/05 F16000 1999/04
CUMMINS C90 D5 / C110 D5 / C150 D5 / C170 D5. CASE IH2188 1998/...A4000 2006/... CASE MAXXUM 135/150 2002/06
VALMET / VALTRA 1180 1991/95 FIAT-ALLIS TRACTOR FD130/FW140/FG140B/FX215C

CUMMINS 6B/6BT 6 CYLINDERS 5.9L 12V (EURO 2)

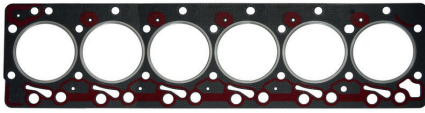

58310501 - THCKNESS 106 MM

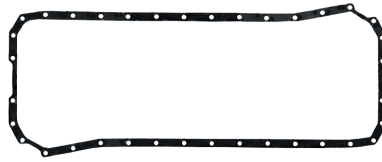

58307290



58310067



58315040

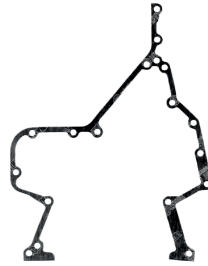

58309867



58311343

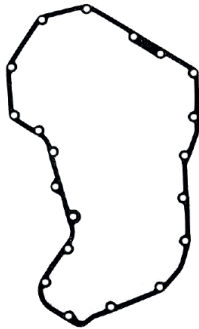

58309447

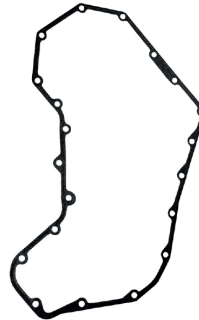

58309547



58309767



58316730



58318467



58311632



58317447



58303850



58308390



58310767



58310816



58303790



58310431



58304616



58310916



58310616



RE05287T



RE07647T

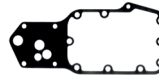

58309647



58311047



58314516



58307016



58312432



58310266



58308066



RE09006S

88310846 HEAD KIT RUBBERS		
N° ABR	DESCRIPTION	QTD
58315240	O RING 50,0X59,25X16,25MM	1
58315140	O RING 9,75 X 19,0 X 8,6 MM	6
50033541	OIL SEAL 9,0 X 1,90MM	6
58311840	O RING 48,0 X 30,0 X 3,0 MM	1
58311940	O RING 72,9 X 69,5 X 1,7 MM	1

88319226 HEAD KIT WASHERS		
N° ABR	DESCRIPTION	QTD
	COPPER WASHER 22,5 X 27,0 X 1,50MM	1
	ALUMINUM WASHER 22,5 X 27,0 X 1,5MM	1
58309224	COPPER WASHER 6,3X10X1,0MM (DUPLA)	6
50011024	COPPER WASHER 7,3 X 15,0 X 2,0 MM	6
50011020	COPPER WASHER 7,3 X 15,0 X 1,0 MM	6
50014424	COPPER WASHER 9,6 X 15,3 X 1,5 MM	6
	STEEL WASHER 9,5 X 20,0 X 2,0 MM	6

88310946 BOTTOM KIT RUBBERS		
N° ABR	DESCRIPTION	QTD
50037341	RING 15,0X2,50MM	1
54355544	O RING 74,0X85,0X9,8/10,2MM	1
58311140	O RING 98,7X88,1X5,2MM	1
58307741	O RING 29,7X33,8X2,0MM	1
58312140	O RING 25,0X28,0X1,6MM	1
58311240	O RING 60,7X50,1X5,2MM	1
58312240	O RING 44,5X41,0X2,5MM	1

88310926 BOTTOM KIT WASHERS		
N° ABR	DESCRIPTION	QTD
50072424	COPPER WASHER 22,5 X 26,7 X 1,50MM	2
	COPPER WASHER 18,2 X 24,0 X 1,5MM	1

CUMMINS ISBe6 5.9L 24V ELETRONIC (EURO 3)

N° SET	DESCRIPTION
68310663	FULL GASKET SET CUMMINS ISBe6 5.9L 24V WITHOUT OIL SEAL
78310663	FULL GASKET SET CUMMINS ISBe6 5.9L 24V WITH OIL SEAL
68330661	HEAD GASKET SET CUMMINS ISBe6 5.9L 24V WITHOUT OIL SEAL
78330661	HEAD GASKET SET CUMMINS ISBe6 5.9L 24V WITH OIL SEAL
68330660	BOTTOM GASKET SET CUMMINS ISBe6 5.9L 24V WITHOUT OIL SEAL
78330660	BOTTOM GASKET SET CUMMINS ISBe6 5.9L 24V WITH OIL SEAL
78310668	FULL GASKET SET CUMMINS ISBe6 5.9L 24V WITH OIL SEAL WITHOUT JET COOLER

N° ABR	N° CUMMINS	DESCRIPTION	1	2	3	4	5	6	7
58329002	2830704	CYLINDER HEAD GASKET Ø107MM – 1,25MM	1						
58329004	2830705	CYLINDER HEAD GASKET Ø107MM – 1,15MM							
58328740	4899231	VALVE COVER GASKET	1		1	1	1	1	
58325431	3955339	EXHAUST MANIFOLD GASKET	6		6	6	6	6	
58328540	4897861	OIL PAN GASKET	1	1	1				1
RE08428T	4890833	REAR OIL SEAL 130X155X14MM		1					1
RE08427T	4890832	FRONT OIL SEAL 70X100X12,5/16MM		1					1
RE08429V	3955393	VALVE STEM SEAL 6,25X12,6X14MM				24	24		
50951490	36832135	OIL DRAINAGE PIPE GASKET	1		1	1	1	1	
58328030	4898301	OIL SUCTION CONNECTION GASKET	1	1	1				1
58328130	4890024	STOM COOLING NOZZLE	6	6	6				6
58328231	4895742	OIL COOLER GASKET	1	1	1				1
58328347	4896409	OIL FILTER GASKET	1	1	1				1
58328431	48 96897	HYDRAULIC PUMP GASKET	1	1	1				1
58328640	4899226	BOTTOM COVER VALVE GASKET	1			1	1	1	1
58328832	3919369	TURBOCHARGING GASKET	1			1	1	1	1
58329132	3932475	TURBOCHARGING GASKET	1			1	1	1	1
88321346		BOTTOM KIT RUBBERS	1	1	1				1
88321446		HEAD KIT RUBBERS	1			1	1	1	1
88321726		HEAD KIT WASHERS	1			1	1	1	1

• SOLD SEPARATELY

APPLICATION



VOLKSWAGEN 17250/23250 2003/...CONSTELLATION 17250/24250/2006/...17250 2007/...

FORD 2428E/2628E 2006/12

AGRALE MT 12.0 LE 2006/12 ; MT 12.0 SB 2004/12

CUMMINS ISBe6 5.9L 24V ELETRONIC (EURO 3)



58329002 - THCKNESS 1,25 MM

58329004 - THCKNESS 1,15 MM



58328540

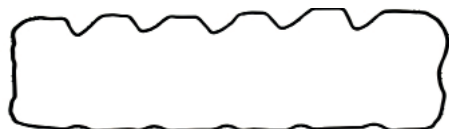

58328640



58328740



58328130



58328030



58325431



50951490



58328431



58355432



58329132



RE08427T



RE08428T



58328347



58328231



RE08429V

88321346 BOTTOM KIT RUBBERS		
N° ABR	DESCRIPTION	QTD
	OIL SEAL 12,30 X 2,40MM	12
	OIL SEAL 56,74 X 3,50MM	1
	OIL SEAL 62,00 X 1,50MM	1
	OIL SEAL 24,00 X 2,50MM	1
	OIL SEAL 21,89 X 2,65MM	1
	OIL SEAL 20,35 X 1,78MM	1
	OIL SEAL 30,00 X 2,50MM	1
	OIL SEAL 29,74 X 3,50MM	1
	OIL SEAL 14,00 X 2,50MM	1
	OIL SEAL 25,50 X 2,50MM	1
	OIL SEAL 11,00 X 1,50MM	1
	OIL SEAL 23,50 X 2,62MM	2
	OIL SEAL 50,00 X 3,00MM	1

88321446 HEAD KIT WASHERS		
N° ABR	DESCRIPTION	QTD
	OIL SEAL 13,30 X 2,40MM	2
	OIL SEAL 17,00 X 3,00MM	2
	OIL SEAL 85,00 X 2,50MM	1
	OIL SEAL 11,50 X 3,00MM	6
	OIL SEAL 54,00 X 4,00MM	1
	OIL SEAL 88,27 X 98,6 X 5,20MM	1
	OIL SEAL 105,00 X 111,60 X 3,50MM	1
	OIL SEAL 21,00 X 2,50MM	1
	OIL SEAL 14,10 X 20,10 X 3,00MM	2
	OIL SEAL 15,50 X 18,20 X 2,80MM	1
	OIL SEAL 8,00 X 2,40 MM	12
	OIL SEAL 9,80 X 1,90 MM	2
	OIL SEAL 21,30 X 3,00MM	6
	OIL SEAL 25,00 X 2,50MM	3

88321726 HEAD KIT WASHERS		
N° ABR	DESCRIPTION	QTD
	ALUMINUM WASHER 12 X 18 X 1,50MM	2
	ALUMINUM WASHER 14 X 24 X 1,50MM	2
	COPPER WASHER 12 X 16 X 1,50MM	2

CUMMINS 6C/6CTA 6 CYLINDERS 8.3L 12V (EURO 2)

Nº SET	DESCRIPTION
68314943	FULL GASKET SET CUMMINS 6C/6CTA WITHOUT OIL SEAL
78314943	FULL GASKET SET CUMMINS 6C/6CTA WITH OIL SEAL
68334941	HEAD GASKET SET CUMMINS 6C/6CTA WITHOUT OIL SEAL
78334941	HEAD GASKET SET CUMMINS 6C/6CTA WITH OIL SEAL
68334940	BOTTOM GASKET SET CUMMINS 6C/6CTA WITHOUT OIL SEAL
78334940	BOTTOM GASKET SET CUMMINS 6C/6CTA WITH OIL SEAL
78314949	FULL GASKET SET CUMMINS 6C/6CTA WITH OIL SEAL WITH O RINGS
78334949	BOTTOM GASKET SET CUMMINS 6C/6CTA WITH OIL SEAL WITH O RINGS

Nº ABR	Nº CUMMINS	Nº VW	DESCRIPTION						
58308101	3935585	2SO103383A	CYLINDER HEAD GASKET EM HTM-S Ø123,5MM –	1		1	1	1	1
58308102	3935586	2RK103383D	CYLINDER HEAD GASKET EM HTM-S Ø123,5MM –						
58308104	3935587	2RK103383E	CYLINDER HEAD GASKET EM HTM-S Ø123,5MM – 2,15MM						
58307443	3905449	TE310483	VALVE COVER GASKET	1		1	1	1	1
58303630	3929012	2RK129589	STEEL COOLER EXHAUST GASKET	6		6	6	6	6
58303098	3914311	2SO129717	EXHAUST COLLECTOR GASKET	1		1	1	1	1
58305798	3934044	2TO103609	OIL PAN GASKET	1	1	1	1		1
58304216	3917780	2RL109289	DISTRIBUTION COVER GASKET	1	1	1	1		1
58304398	3929253	TJG109235	GEAR COVER HOUSING GASKET	1	1	1	1		1
RE05287T	3909410	2SO103085A	REAR OIL SEAL	1	1	1			1
RE05536T	3353977	2RK109215	FRONT OIL SEAL	1	1	1			1
RE09005S	3915707 / 3919038	2RK109675	VALVE STEM SEAL (WITH METAL SUPPORT)	12		12			12
50950890	3931350		TUBE SUCTION GASKET	1		1	1	1	1
58303198	3914301	TJG103037	REAR COVER GASKET	1	1	1	1		1
58303290	3916042	2TO145818A	COMPRESSOR GASKET	1	1	1	1		1
58303316	3918174	TJG115441	FILTER GASKET DE ÓLEO	1	1	1	1		1
58303790	3901805	2SO145757	OIL DRAINAGE PIPE GASKET	1		1	1	1	1
58303998	3914302	TJG115259	OIL PIPE GASKET	1	1	1	1		1
58304016	3914308	2RK115441	FILTER GASKET DE ÓLEO (OLD)	1	1	1	1		1
58304616	3939258	2TD130123A	FUEL PUMP GASKET	1	1	1	1		1
58306331	3352494	TE3253135A	OIL RETURN TURBO GASKET	2		2	2	2	2
58306490	3914310	TJG121119	TERMOSTATIC HOUSING GASKET	1		1	1	1	1
58306590	3917892	TF3145647	INTAKE CONEXION GASKET	1		1	1	1	1
58306790	3060912	2RK121809	INTAKE CONEXION GASKET	1		1	1	1	1
58307016	3931348	TAF130123	THERMOSTATS GASKET	1	1	1	1		1
58307390	3921440	TJG129719	INTAKE COVER MANIFOLD GASKET	1		1	1	1	1
58307536	3911941	TF3145453	EXHAUST PIPE GASKET	1		1	1	1	1
58307966	3905928	TJG113117	STOM COOLING NOZZLE(UP TO 1990)	6	6	6	6		6
58308390	3931607	2SO130119	INJECTION PUMP GASKET	1	1	1	1		1
58308490	176027	2RL145617A	AIR COMPRESSOR SUPPORT GASKET	1	1	1	1		1
58308531	3575909	TRA145453	TURBINE RING	1		1	1	1	1
58310116	3929011	2RK115441A	OIL FILTER GASKET (MODER)	1	1	1	1		1
58310266	3930139	TJG103117	STOM COOLING NOZZLE(AFTER 1990)	12	12	12	12		12
58310341	3912473	TF3103221	O RING	1	1	1	1		1
58314445	3907177	TE3107125	LINER RING	6	6				
58316267	3354398	TLG129717	INTAKE COVER MANIFOLD GASKET	1	1		1	1	1
58316367	TJG103609	TJG103609	GASKET	1	1	1			1
58317830	3914708	TJG129789	BLOCK COVER GASKET	12		12	12	12	12
88310146			HEAD KIT RUBBERS	1	1		1	1	1
88310126			HEAD KIT WASHERS	1	1		1	1	1
88310246			BOTTOM KIT RUBBERS	1	1	1	1		1
88310226			BOTTOM KIT RUBBERS	1	1	1	1		1

• SOLD SEPARATELY

APPLICATION

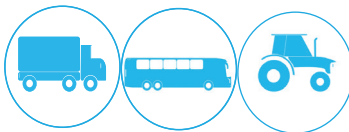

VOLKSWAGEN 14210 1988/91 ; 16210/16210H 1989/91 ; 16170 1988/93 ; 16220 1990/00 ; 24220 1990/01 ; 35300 1991/99 ;
 14220 1991/98 ; 40300 1999/01 ; 17300 2000/02 ; 23310/26310/26220/26260 2002/04 ; 17310/18310 2002/06 ; 23220 2002/06 ;
 24250 1992/01 ; 16300 1996/00 ; 17220 2000/12 ; 26300 2001/01 ; 22210 1988/88 ; 24220 2006/12 ;

VOLKSWAGEN 17210 OD 2001/...18310 OT 2003/...

FORD TRUCK C-1422 1991/00 ; C-1617 1992/99 ; C-1622 1991/02 ; C-1722 1999/02 ; C-2322 1991/96 ; C-2422 1993/05 ;
 C-3621/22 1994/01 ; C-1731/C-3222 2003/05 ; C-2324/C-3224 1992/97 ; C-2425 1996/02 ; C-2622 2002/05 ; C-2626 2002/06 ;
 C-2630 1998/02 ; C-2831 2005/05 ; C-3530 1991/97 ; C-4030 1994/02 ; C-4031 2002/05 ; C-4331 2003/06 ; C-5031 2005/05 ;
 C-1630 2001/02 ; C-1721 2002/05 ; C-1722 2002/05 ; C-2631 2002/05 ;

FORD COMBINE CS660 2004/16 ; CS6090 2015/...TC5090 2008/16 ;

CASE COMBINE IH2155 1998/...AF2166 1996/99 ; AF2366 1998/03 ; AF2388 1998/10 ; AF2399 2006/10 ; AF2566 2011/15 ;
 AF2688/2799 2010/15 ; A7000/A7700 2001/08;

MASSEY FERGUSON COMBINE MF34 1998/11 ; MF38 1998/06 ; FIAT TRACTOR FD170 1995/05

CASE TRACTOR MAXXUM 165/180 ; MAGNUM 240/270 2002/06 ; 220 2002/...305 2009/...8920/8940 1992/...

CUMMINS 6C/6CTA 6 CYLINDERS 8.3L 12V (EURO 2)

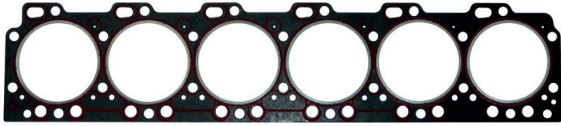

58308101 - THCKNESS 1,65 MM
58308102 - THCKNESS 1,90 MM
58308104 - THCKNESS 2,15 MM



58305798



58307443



58303098

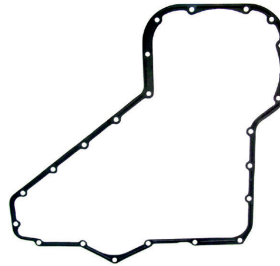

58304216

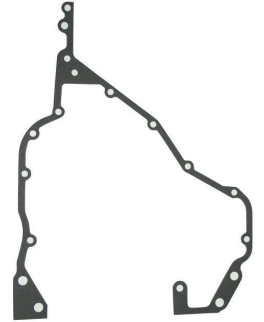

58304398



58307390



58316267

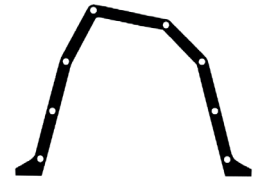

58303198

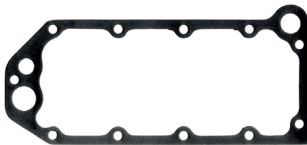

58303316

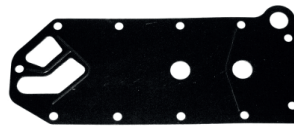

58304016

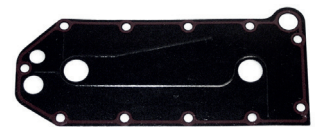

58310116



58306790



58303630



58304616



58303290



58317830



58303790

CUMMINS 6C/6CTA 6 CYLINDERS 8.3L 12V (EURO 2)



58303998



50950890

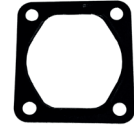

58307536



58316367



58308390



58306590



58306331



RE05536T



RE05287T



58308531



58306490



RE09005S



58307016



58308490



58310266



58307966

88310246 BOTTOM KIT RUBBERS		
N° ABR	DESCRIPTION	QTD
50007841	OIL SEAL 27,0 X 3,3MM	1
58307741	OIL SEAL 29,7X33,8X2,0MM	1
58307641	OIL SEAL 39X59,8X2,0MM	1
50046541	OIL SEAL 101,3 X 3,0MM	1
50026941	OIL SEAL 75,0 X 3,0MM	1
50046041	OIL SEAL 102,0X2,0MM	1
50010841	OIL SEAL 25,5 X 2,8MM	1
50037341	OIL SEAL 15,0X2,50MM	1
54386740	OIL SEAL 12,5X2,6MM	1
58310341	OIL SEAL 157,00X163,1X7,0MM	1

88310226 BOTTOM KIT WASHERS		
N° ABR	DESCRIPTION	QTD
50028724	COPPER WASHER 22,3 X 27,9 X 1,50MM	1
50030720	COPPER WASHER 26,3 X 30,9 X 2,00MM	1
50025124	COPPER WASHER 18,2 X 23,5 X 1,50MM	1

88310126 HEAD KIT WASHERS		
N° ABR	DESCRIPTION	QTD
50951720	COPPER WASHER 7,3X15,3X1,98/2,08MM	6
58309224	COPPER WASHER 6,3X10X1,0MM (PAIR)	7
	COPPER WASHER 22,3 X 28,2 X 1,50MM	2
50070729	ALUMINUM WASHER 12,7 X 17,8 X 1,5MM	4
50084029	ALUMINUM WASHER 14,6 X 20,8 X 1,5MM	2

88310146 HEAD KIT RUBBERS		
N° ABR	DESCRIPTION	QTD
50004341	OIL SEAL 14,0X19,0X3,2MM	1
50040041	OIL SEAL 18,0 X 2,50MM	1
50033541	OIL SEAL 9,0 X 1,90MM	6
50046141	OIL SEAL 68,1X 2,0MM	1

CUMMINS ISC 8.3LITRO 24V ELETRONIC(EURO 3)/ISL 8.9L 24V ELETRONICEURO 5)

SET	DESCRIPTION				
68310593	FULL GASKET SET CUMMINS ISC 8.3L/ ISL 8.9L WITHOUT OIL SEAL				1
78310593	FULL GASKET SET CUMMINS ISC 8.3L/ ISL 8.9L WITH OIL SEAL				2
68330591	HEAD GASKET SET CUMMINS ISC 8.3L/ ISL 8.9L WITHOUT OIL SEAL				3
78330591	HEAD GASKET SET CUMMINS ISC 8.3L/ ISL 8.9L WITH OIL SEAL				4
68330590	BOTTOM GASKET SET CUMMINS ISC 8.3L/ ISL 8.9L WITHOUT OIL SEAL				5
78330590	BOTTOM GASKET SET CUMMINS ISC 8.3L/ ISL 8.9L WITH OIL SEAL				6
Nº ABR	Nº CUMMINS	DESCRIPTION			
58325701	3967059	CYLINDER HEAD GASKET Ø123,5MM -1,70MM		1	1 1 1
58327140	3959798	VALVE COVER GASKET		1	1 1 1
58325531	3937479	EXHAUST MANIFOLD GASKET		6	6 6 6
58329667	3944646	EXHAUST COLLECTOR GASKET		1	1 1 1
58305767	3938160	OIL PAN GASKET		1	1 1
58303198	3939353	REAR COVER GASKET		1	1 1
58327447	3944293	GEAR HOUSING GASKET		1	1 1
RE05287T	3909410	REAR OIL SEAL		1	1
RE05536T	3353977	FRONT OIL SEAL		1	1
RE08432V	3943888	VALVE STEM SEAL		24	24
56121231	3901356	TURBOCHARGING GASKET		1	1 1 1
58303347	3918174	OIL COOLER GASKET		1	1 1
58303790	3937706	OIL DRAINAGE PIPE GASKET		1	1 1 1
58303998	3914302	OIL PIPE GASKET		1	1 1
58310116	3929011	FILTER GASKET DE ÓLEO		1	1 1
58327067	3967891	INTAKE MANIFOLD GASKET		1	1 1 1
58327340	3966708	BOTTOM COVER VALVE GASKET		1	1 1 1
58327567	3940245	OIL COOLER GASKET		1	1 1
58327647	3945603	INTAKE WATER CONECTION GASKET		1	1 1
58327730	4902952	FUEL PUMP GASKET		1	1 1
58327830	3755843	TURBOCHARGING GASKET		1	1 1 1
58329767	3992090	INTAKE COVER MANIFOLD GASKET		1	1 1 1
88321546		HEAD KIT RUBBERS		1	1 1 1
88321646		BOTTOM KIT RUBBERS		1	1 1
88321826		HEAD KIT WASHERS		1	1 1 1
88321926		BOTTOM KIT WASHERS AND RUBBERS		1	1 1

• SOLD SEPARATELY

APPLICATION

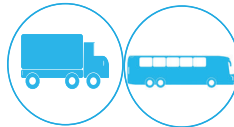

VOLKSWAGEN TRUCK ISC 31310 2005/...19320 2006/...25320 2008/...31320 2007/...VW BUS ISC 18320 EOT 2006/12
VOLKSWAGEN TRUCK ISL 24330/19420/25420/26420 2013/...19330/30330/19360 2015/...17330/19390/25360/25390/26390 2017/...
VOLKSWAGEN BUS ISL 18330 OT 2018/...
FORD TRUCK ISC C-2831E/C4331E/C-5031E 2005/06 ; C-1932E/C-3132E 2011/12 ; C-4432E 2006/07 ; C-4532E 2007/11 ;
C-6632E 2008/11 ; C-2632E/C-2932E/C-5032E 2006/08 ; C-1832E 2010/11 ; FORD TRUCK ISL 1933E 2014/2018 ; 3133E 2012/...

CUMMINS ISC 8.3L 24V ELETRONIC(EURO 3)/ISL 8.9L 24V ELETRONIC(EURO 5)

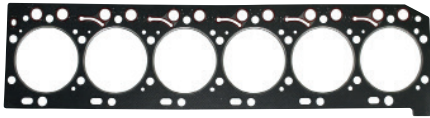

58325701 - THCKNESS 1,70 MM



58305767



58329667



58327340



58327140

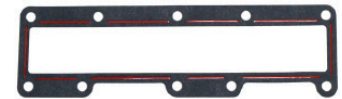

58329767

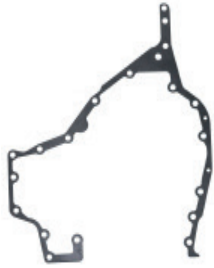

58327447

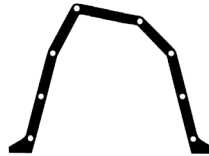

58303198



58327730



58303790



58303998



58325531



58327830



RE05287T



RE05536T



58121231



58327067



58327647



58327567



58303347



58310116



RE08432V

88321546 HEAD KIT RUBBERS		
N° ABR	DESCRIPTION	QTD
	OIL SEAL 11,50 X 2,70MM	6
	OIL SEAL 11,20 X 2,50MM	3
	OIL SEAL 9,50X 2,00MM	2
	OIL SEAL 8,00 X 1,70 MM	1
	OIL SEAL 15,60 X 2,30MM	1
	OIL SEAL 16,50 X 2,62MM	2
	OIL SEAL 85,00 X 2,50MM	1
	OIL SEAL 61,66 X 2,62MM	1
	OIL SEAL 19,00 X 1,50MM	1
	OIL SEAL 48,50 X 3,00MM	1
	OIL SEAL 30,00 X 2,50MM	1
	OIL SEAL 25,00 X 2,60MM	2
	OIL SEAL 21,00 X 3,00MM	6

88321826 HEAD KIT WASHERS		
N° ABR	DESCRIPTION	QTD
	COPPER WASHER 8 X 15 X 1,50MM	6
	COPPER WASHER 18 X 24 X 1,50MM	1
	ALUMINUM WASHER 14 X 24 X 1,50MM	1
	ALUMINUM WASHER 14 X 22,50 X 1,50MM	5
	ALUMINUM WASHER 12 X 19,50 X 1,50MM	25

88321646 BOTTOM KIT RUBBERS		
N° ABR	DESCRIPTION	QTD
	OIL SEAL 21,82 X 3,50MM	1
	OIL SEAL 66,40 X 1,78MM	2
	OIL SEAL 25,00 X 2,60MM	1
	OIL SEAL 110,72 X 3,53MM	1
	OIL SEAL 8,00 X 1,50MM	1
	OIL SEAL 7,50 X 2,50MM	2
	OIL SEAL 9,25 X 1,78MM	1
	OIL SEAL 11,30 X 2,00MM	4
	OIL SEAL 15,50 X 2,00MM	1
	OIL SEAL 19,25 X 2,20MM	3
	OIL SEAL 18,72 X 2,62MM	1
	OIL SEAL 20,35 X 1,78MM	1
	OIL SEAL 62,00 X 2,50MM	1
	OIL SEAL 152,85X158,85X7,0MM	1

88321926 BOTTOM KIT WASHERS		
N° ABR	DESCRIPTION	QTD
	COPPER WASHER 18 X 24 X 1,50MM	1
	ALUMINUM WASHER 14 X 22,50 X 1,50MM	3
	ALUMINUM WASHER 12 X 19,50 X 1,50MM	13

CUMMINS ISB4.5/QSB4.5 16V ELETRONIC(EURO 5)

N° SET	DESCRIPTION
68310772	FULL GASKET SET CUMMINS ISB4.5 / QSB4.5 WITHOUT OIL SEAL
78310772	FULL GASKET SET CUMMINS ISB4.5 / QSB4.5 WITH OIL SEAL
68330771	HEAD GASKET SET CUMMINS ISB4.5 / QSB4.5 WITHOUT OIL SEAL
78330771	HEAD GASKET SET CUMMINS ISB4.5 / QSB4.5 WITH OIL SEAL
68330770	BOTTOM GASKET SET CUMMINS ISB4.5 / QSB4.5 WITHOUT OIL SEAL
78330770	BOTTOM GASKET SET CUMMINS ISB4.5 / QSB4.5 WITH OIL SEAL
78310778	FULL GASKET SET CUMMINS ISB4.5 / QSB4.5 WITH OIL SEAL WITHOUT JET COOLER
78330778	BOTTOM GASKET SET CUMMINS ISB4.5 / QSB4.5 WITH OIL SEAL WITHOUT JET COOLER

N° ABR	N° CUMMINS	DESCRIPTION	1	2	3	4	5	6	7	8
58330402	4932209	CYLINDER HEAD GASKET Ø 110 MM	1	1						
58329340	4899228	VALVE COVER GASKET	1	1						
58325431	3955339	EXHAUST MANIFOLD GASKET	4	4						
58313067	3938153	EXHAUST COLLECTOR GASKET	1	1						
58327940	4899877	OIL PAN GASKET		1	1	1				
RE05287T	3909410	REAR OIL SEAL		1	1					
RE08427T	4890832	FRONT OIL SEAL		1	1					
RE08429V	3955393	VALVE STEM SEAL	16	16						
58304616	3939258	FUEL PUMP GASKET		1	1	1				
58310616	4898280	HYDRAULIC PUMP GASKET		1	1	1				
58318467	3969988	INTAKE COVER MANIFOLD GASKET	1	1						
58328030	4898301	OIL SUCTION CONNECTION GASKET		1	1	1				
58328130	4890024	STOM COOLING NOZZLE		4	4	4				
58328247	4895742	OIL COOLER GASKET		1	1	1				
58328347	4896409	OIL FILTER GASKET	1	1						
58328467	4896897	HYDRAULIC PUMP GASKET		1	1	1				
58329132	3932475	TURBOCHARGING GASKET	1	1						
58329440	4899230	VALVE COVER GASKET INFERIOR	1	1						
58330767	3819900	TUBE SUCTION GASKET	1	1						
58330830	4896254	TURBOCHARGING GASKET	1	1						
58330967	3949562	OIL PIPE GASKET		1	1	1				
88320440		HEAD KIT RUBBERS	1	1						
88320540		BOTTOM KIT WASHERS AND RUBBERS	1	1	1					

• SOLD SEPARATELY

APPLICATION

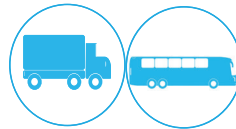

FORD 1119E 2014/...1319E 2012/17 ; 1419E 2016/...1519E 2013/...816E 2012/...

AGRALE 14000 2013/...14000S 2017...AGRALE BUS MA 15.0 2013/...

CUMMINS ISB4.5/QSB4.5 16V ELETTRONIC(EURO 5)



58330402 - THCKNESS 110 MM

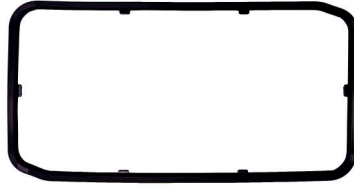

58327940

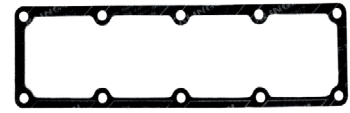

58313067



58329340



58329440



58328130



58328467



58310616



RE08427T



RE05287T



58328347



58328247



58330830



58325431



58304616



58330767



58318467



58329132



58330967



58328030



RE08429V



88320540



88320440

CUMMINS ISB6.7/QSB6.7 24V ELETRONIC(EURO 5)

N° SET	DESCRIPTION
68310752	FULL GASKET SET CUMMINS ISB6.7/QSB6.7 24V WITHOUT OIL SEAL
78310752	FULL GASKET SET CUMMINS ISB6.7/QSB6.7 24V WITH OIL SEAL
68330751	HEAD GASKET SET CUMMINS ISB6.7/QSB6.7 24V WITHOUT OIL SEAL
78330751	HEAD GASKET SET CUMMINS ISB6.7/QSB6.7 24V WITH OIL SEAL
68330750	BOTTOM GASKET SET CUMMINS ISB6.7/QSB6.7 24V WITHOUT OIL SEAL
78330750	BOTTOM GASKET SET CUMMINS ISB6.7/QSB6.7 24V WITH OIL SEAL
78310758	FULL GASKET SET CUMMINS ISB6.7/QSB6.7 24V WITH OIL SEAL WITHOUT JET COOLER
78330758	BOTTOM GASKET SET CUMMINS ISB6.7/QSB6.7 24V WITH OIL SEAL WITHOUT JET COOLER

N° ABR	N° CUMMINS	DESCRIPTION	1	2	3	4	5	6	7	8
58330302	4932210	CYLINDER HEAD GASKET Ø 110 MM	1	1	1	1	1	1	1	1
58328740	4899231	VALVE COVER GASKET	1	1	1	1	1	1	1	1
58325431	3955339	EXHAUST MANIFOLD GASKET	6	6	6	6	6	6	6	6
58310067	3947530/3931347	EXHAUST COLLECTOR GASKET	1	1	1	1	1	1	1	1
58328540	4897861/4948344	OIL PAN GASKET	1	1	1				1	1
RE05287T	390940	REAR OIL SEAL Ø 130X150X14MM	1	1					1	
RE08427T	480832	FRONT OIL SEAL Ø 78X100X12,5/16MM	1	1					1	
RE08429V	3955393	VALVE STEM SEAL	24	24	24	24				
58304616	3939258	FUEL PUMP GASKET	1	1	1				1	1
58310616	4898280	HYDRAULIC PUMP GASKET	1	1	1				1	1
58318467	3969988	INTAKE COVER MANIFOLD GASKET	1	1		1	1		1	1
58328030	4898301	OIL SUCTION CONNECTION GASKET	1	1	1				1	1
58328130	4890024	STOM COOLING NOZZLE	1	6	6				1	1
58328247	4895742	OIL COOLER GASKET	1	1	1				1	1
58328347	4896409	OIL FILTER GASKET	1	1	1				1	1
58328467	4896897	HYDRAULIC PUMP GASKET	1	1	1				1	1
58328640	4899226	VALVE COVER GASKET INFERIOR	1	1		1	1		1	1
58329132	3932475	TURBOCHARGING GASKET	1	1		1	1		1	1
58330767	3819900	TUBE SUCTION GASKET	1	1		1	1		1	1
58330830	4896254	EXHAUST MANIFOLD GASKET	1	1		1	1		1	1
58330967	3949562	OIL PIPE GASKET	1	1	1				1	1
88320640		HEAD KIT WASHERS AND RUBBERS	1	1		1	1		1	1
88321226		BOTTOM KIT WASHERS	1	1	1				1	1
88321346		BOTTOM KIT RUBBERS	1	1	1				1	1

• SOLD SEPARATELY

APPLICATION

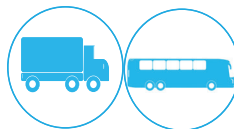

FORD 1723E/2423E/2429E/2629E 2012/...1729E 2014/2018 ; 1731E/2431E/2631E/3031E/3131E 2018/...2623E 2013/...
3129E 2016/...AGRALE MA 17.0 2013/...

CUMMINS ISB6.7/QSB6.7 24V ELETRONIC(EURO 5)

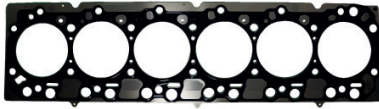

58330302 - THCKNESS 110 MM



58328540

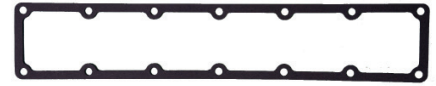

58310067



58328640



58328740



58328130



58328467



58310616



RE08427T



RE20528T



58328347



58328247



58330830



58325431



58304616



58330767



58318467



58329132



58330967



58328030



RE08429T

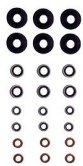

88320640

88321346 BOTTOM KIT RUBBERS		
N° ABR	DESCRIPTION	QTD
	OIL SEAL 12,30 X 2,40MM	12
	OIL SEAL 56,74 X 3,50MM	1
	OIL SEAL 62,00 X 1,50MM	1
	OIL SEAL 24,00 X 2,50MM	1
	OIL SEAL 21,89 X 2,65MM	1
	OIL SEAL 20,35 X 1,78MM	1
	OIL SEAL 30,00 X 2,50MM	1
	OIL SEAL 29,74 X 3,50MM	1
	OIL SEAL 14,00 X 2,50MM	1
	OIL SEAL 25,50 X 2,50MM	1
	OIL SEAL 11,00 X 1,50MM	1
	OIL SEAL 23,50 X 2,62MM	2
	OIL SEAL 50,00 X 3,00MM	1

88321226 BOTTOM KIT WASHERS		
N° ABR	DESCRIPTION	QTD
	ALUMINUM WASHER 14 X 22 X 1,50MM	6
	ALUMINUM WASHER 8 X 13,5 X 1,00MM	6
	COPPER WASHER 8,5 X 14 X 1,50MM	6

CUMMINS ISF 4 CYLINDERS 3.8L 16V (EURO 5)

N° SET	DESCRIPTION		
78310732	FULL GASKET SET CUMMINS ISF 4 CYLINDERS 3.8L WITH OIL SEAL		1
78330732	HEAD GASKET SET CUMMINS ISF 4 CYLINDERS 3.8L WITH OIL SEAL		2
78330730	BOTTOM GASKET SET CUMMINS ISF 4 CYLINDERS 3.8L WITH OIL SEAL		3

N° ABR	N° CUMMINS	DESCRIPTION		
58330502	5257187	CYLINDER HEAD GASKET Ø 107MM	1	1
58332040	5255312	VALVE COVER GASKET	1	1
58332330	5261421	EXHAUST MANIFOLD GASKET	4	4
56332267	4983654	EXHAUST COLLECTOR GASKET	1	1
58331240	4995750	OIL PAN GASKET 1 BOCAL	1	1
58332140	5256541	OIL PAN GASKET 2 BOCAL	1	1
RE09122T	5265267	REAR OIL SEAL 130X150X14MM	1	1
RE09118T	5265266	FRONT OIL SEAL 70X100X12,5/16MM	1	1
RE09119F	4976170	VALVE STEM SEAL 6,25X12,6X14MM	16	16
58329132	3932475	HYDRAULIC PUMP GASKET	1	1
58330767	3819900	TURBOCHARGING GASKET	1	1
58331730	5255538	TUBE SUCTION GASKET	1	1
58331830	4995186	OIL PUMP GASKET	1	1
58331940		OIL FILTER GASKET	1	1
58332440	5255313	VALVE COVER GASKET	4	4
58332540	5255314	TURBO CHARGING GASKET	1	1
58332630	5262686	OIL PUMP GASKET	1	1
58332730	5264426	KIT WASHERS AND RUBBERS		1
58332840	5264477	HEAD KIT WASHERS AND RUBBERS	1	
58332940	5262903	OIL COOLER GASKET 24X40X7MM		1

• SOLD SEPARATELY

APPLICATION



VOLKSWAGEN 8160/9160 2012/...10160 2013/...13160 2015/...DELIVERY 9170/11180/13180 2018/...
VOLKSWAGEN 8160 OD 2012/...9160 OD 2014/...10160 ODR 2017/...
AGRALE 8700 LX/10000 LX 2016/17 8700/10000 2013/...A7500/A8700/A10000 2016/...8700S/8700TR/10000S 2017/...
VOLARE V5/V6/V8 2012/14 W6 FLY/W7 FLY 2013/14 V6L 2014/17 W6/W7/V8L 2014/...V9L 2017/...
FOTON 10-16DT 2017/...

CUMMINS ISF 4 CYLINDERS.3.8L 16V (EURO 5)

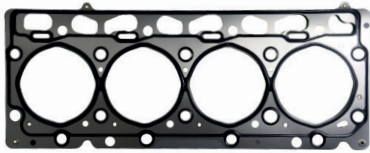

58330602 - THCKNESS 107 MM

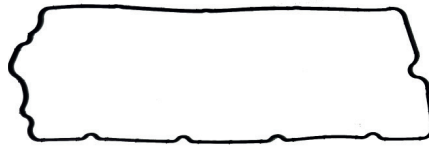

58331140

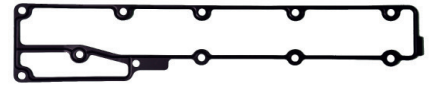

58331330

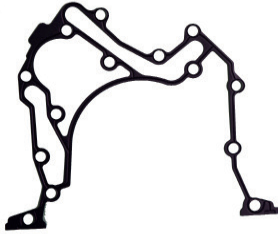

58331430

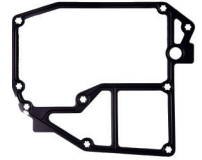

58331530

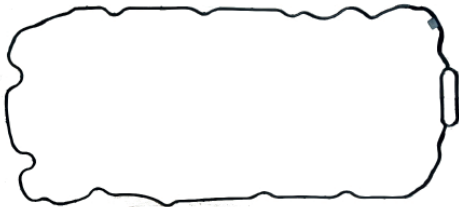

58331240



58332140



58328467



58325431



58331730



58331830



58330767



58329132



RE08427T



RE05287T



RE09123F



58331640



RE08429V

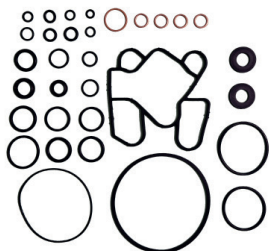

88520840

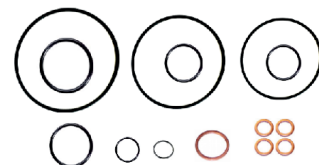

88321140

CUMMINS ISF 4 CYLINDERS.2.8L 16V (EURO 5)

N° SET		DESCRIPTION		
78310712		FULL GASKET SET CUMMINS ISF 4 CYLINDERS 2.8L WITH OIL SEAL	1	
78330712		HEAD GASKET SET CUMMINS ISF 4 CYLINDERS 2.8L WITH OIL SEAL	2	
78330710		BOTTOM GASKET SET CUMMINS ISF 4 CYLINDERS 2.8L WITH OIL SEAL	3	
N° ABR	N° CUMMINS	DESCRIPTION		
58330502	5257187	CYLINDER HEAD GASKET Ø 95,6 MM	1	1
58332040	5255312	VALVE COVER GASKET	1	1
58332330	5261421	EXHAUST MANIFOLD GASKET	1	1
56332267	4983654	EXHAUST COLLECTOR GASKET	1	1
58331040	4980644	OIL PAN GASKET 1 BOCAL	1	1
58332140	5256541	OIL PAN GASKET 2 BOCAL	1	1
RE09122T	5265267	REAR OIL SEAL	1	1
RE09118T	5265266	FRONT OIL SEAL	1	1
RE09119F	4976170	VALVE STEM SEAL 6,25X12,6X14MM	16	16
58329132	3932475	TURBOCHARGING GASKET	1	1
58330767	3819900	TUBE SUCTION GASKET	1	1
58331730	5255538	TURBO CHARGING GASKET	1	1
58331830	4995186	EXHAUST PIPE GASKET	1	1
58331940		VALVE COVER GASKET	1	1
58332440	5255313	VALVE OIL SEAL	4	4
58332540	5255314	ROCKER COVER BOLT SEALER	4	4
58332630	5262686	OIL PUMP GASKET	1	1
58332730	5264426	EXHAUST PIPE GASKET	1	1
58332840	5264477	GEAR BOX GASKET	1	1
58332940	5262903	OIL COOLER GASKET	1	1
58333040	5263530	GEAR BOX GASKET	1	1

• SOLD SEPARATELY

APPLICATION



VOLKSWAGEN DELIVERY 4150/6160/EXPRESS 2017/...FORD F350 2015/...F4 MILHA 2015/...F4000 2015/...
AGRALE MARRUÁ M200 2015/...AGRALE MA 8.7/MA 9.2/MA 10.0 2013/...VOLARE FIVE 2016/...
FOTON 3.5-12DT/3.5-12ST/3.5-14DT/3.5-14ST/AUMARK 3.5-11DT/3.5-11ST 2017/...

CUMMINS ISF 4 CYLINDERS.2.8L 16V (EURO 5)



58330502 - THCKNESS 95,6 MM



58332267



58332330

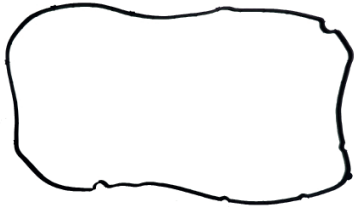

58332040



58332330

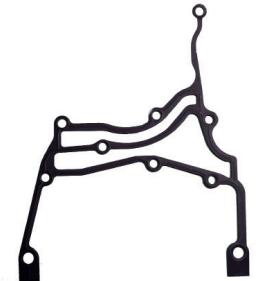

58332630



58331940



58332940



58332840

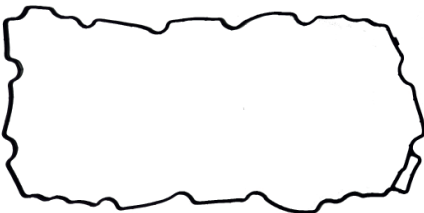

58331040



58332140



58332730



58331730



58331830



RE09122T



RE09118T



58332440



58332540



58329132



58330767

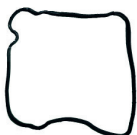

58333040



RE09119F



MERCEDES



MERCEDES

Nº ABR	ENGINE	DESCRIPTION		PAGE
66116081	OM314	FULL GASKET SET	WITHOUT OIL SEAL WITH CYLINDER HEAD GASKET 98,5 MM	40
76116081	OM314	FULL GASKET SET	WITH OIL SEAL WITH CYLINDER HEAD GASKET 98,5 MM	40
76126081	OM314	FULL GASKET SET	WITH OIL SEAL WITH CYLINDER HEAD GASKET 100,0 MM	40
76136081	OM314	HEAD GASKET SET	WITH OIL SEAL WITH CYLINDER HEAD GASKET 98,5 MM	40
76121681	OM364	FULL GASKET SET	WITH OIL SEAL WITH CYLINDER HEAD GASKET 98,5 MM	46
76111681	OM364	FULL GASKET SET	WITH OIL SEAL WITH CYLINDER HEAD GASKET 100,0 MM	46
76121671	OM364A	FULL GASKET SET	WITH OIL SEAL WITH CYLINDER HEAD GASKET 98,5 MM	46
76111671	OM364A	FULL GASKET SET	WITH OIL SEAL WITH CYLINDER HEAD GASKET 100,0 MM	46
76131671	OM364/364A	HEAD GASKET SET	WITH OIL SEAL WITH CYLINDER HEAD GASKET 98,5 MM	46
76131681	OM364/364A	HEAD GASKET SET	WITH OIL SEAL WITH CYLINDER HEAD GASKET 100,0 MM	46
76141721	OM352	FULL GASKET SET	WITH OIL SEAL WITH CYLINDER HEAD GASKET 98,5 MM	50
76121721	OM352	FULL GASKET SET	WITH OIL SEAL WITH CYLINDER HEAD GASKET 100,0 MM	50
76141031	OM352A/LA	FULL GASKET SET	WITH OIL SEAL WITH CYLINDER HEAD GASKET 98,5 MM	50
76121031	OM352A/LA	FULL GASKET SET	WITH OIL SEAL WITH CYLINDER HEAD GASKET 100,0 MM	50
76131721	OM352A/LA	HEAD GASKET SET	WITH OIL SEAL WITH CYLINDER HEAD GASKET 98,5 MM	50
76131031	OM352A/LA	HEAD GASKET SET	WITH OIL SEAL WITH CYLINDER HEAD GASKET 100,0 MM	50
66113121	OM355/5 CYLINDERS	FULL GASKET SET	WITHOUT OIL SEAL	54
76113121	OM355/5 CYLINDERS	FULL GASKET SET	WITH OIL SEAL	54
76133121	OM355/5 CYLINDERS	HEAD GASKET SET	WITH OIL SEAL	54
66112501	OM355/6 CYLINDERS	FULL GASKET SET	WITHOUT OIL SEAL	58
76112501	OM355/6 CYLINDERS	FULL GASKET SET	WITH OIL SEAL	58
76132501	OM355/6 CYLINDERS	HEAD GASKET SET	WITH OIL SEAL	58
76121691	OM366	FULL GASKET SET	WITH OIL SEAL WITH CYLINDER HEAD GASKET 98,5 MM	62
76111691	OM366	FULL GASKET SET	WITH OIL SEAL WITH CYLINDER HEAD GASKET 100,0 MM	62
76121701	OM366A	FULL GASKET SET	WITH OIL SEAL WITH CYLINDER HEAD GASKET 98,5 MM	62
76141701	OM366A	FULL GASKET SET	WITH OIL SEAL WITH CYLINDER HEAD GASKET 100,0 MM	62
76112791	OM366LA	FULL GASKET SET	WITH OIL SEAL WITH CYLINDER HEAD GASKET 100,0 MM	62
76131701	OM366A/366LA	HEAD GASKET SET	WITH OIL SEAL WITH CYLINDER HEAD GASKET 98,5 MM	62
76131691	OM366A/366LA	HEAD GASKET SET	WITH OIL SEAL WITH CYLINDER HEAD GASKET 100,0 MM	62
76196115	OM447A/447LA	FULL GASKET SET	WITH OIL SEAL	66
66196115	OM447A/447LA	FULL GASKET SET	WITHOUT OIL SEAL	66
76196125	OM449A/449LA	FULL GASKET SET	WITH OIL SEAL	66
66196125	OM449A/449LA	FULL GASKET SET	WITHOUT OIL SEAL	66
76136125	OM447/OM449	MONOCYLINDER GASKET SET	WITH OIL SEAL	66
66136125	OM447/OM449	MONOCYLINDER GASKET SET	WITHOUT OIL SEAL	66
66114611	OM457LA	FULL GASKET SET	WITHOUT OIL SEAL WITHOUT LINER LING (UP TO 32558)	68
76114611	OM457LA	FULL GASKET SET	WITH OIL SEAL WITHOUT LINER RINGS (UP TO 32558)	68
76114619	OM457LA	FULL GASKET SET	WITH OIL SEAL WITH LINER RINGS(UP TO 32558)	68
66134611	OM457LA	MONOCYLINDER GASKET SET	WITHOUT OIL SEAL WITHOUT LINER RINGS (UP TO 32558)	68
76134611	OM457LA	MONOCYLINDER GASKET SET	WITH OIL SEAL WITHOUT LINER RINGS (UP TO 32558)	68
76134619	OM457LA	MONOCYLINDER GASKET SET	WITH OIL SEAL WITH LINER RINGS (UP TO 32558)	68
66114631	OM457LA	FULL GASKET SET	WITHOUT OIL SEAL WITHOUT LINER RINGS (UP TO 32559)	70
76114631	OM457LA	FULL GASKET SET	WITH OIL SEAL WITHOUT LINER RINGS(UP TO 32559)	70
76114639	OM457LA	FULL GASKET SET	WITH OIL SEAL WITH LINER RINGS(UP TO 32559)	70
76134599	OM457LA	MONOCYLINDER GASKET SET	WITH OIL SEAL WITH LINER RINGS (UP TO 32559)	70
76134609	OM457LA	MONOCYLINDER GASKET SET	WITH OIL SEAL WITH LINER RINGS (UP TO 32559)	70
76114651	OM611	FULL GASKET SET	WITH OIL SEAL	72
76134651	OM611	HEAD GASKET SET	WITH OIL SEAL	72
76119041	OM904	FULL GASKET SET	WITH OIL SEAL FOR PLASTIC VALVE COVER	74
66119041	OM904	FULL GASKET SET	WITHOUT OIL SEAL FOR PLASTIC VALVE COVER	74
76119241	OM924	FULL GASKET SET	WITH OIL SEAL FOR PLASTIC VALVE COVER	74
66119241	OM924	FULL GASKET SET	WITHOUT OIL SEAL FOR PLASTIC VALVE COVER	74
76139041	OM904	HEAD GASKET SET	WITH OIL SEAL FOR PLASTIC VALVE COVER	74
76139241	OM904	HEAD GASKET SET	WITH OIL SEAL FOR PLASTIC VALVE COVER	74
76119061	OM906	FULL GASKET SET	WITH OIL SEAL FOR PLASTIC VALVE COVER	76
66119061	OM906	FULL GASKET SET	WITHOUT OIL SEAL FOR PLASTIC VALVE COVER	76
76119261	OM926	FULL GASKET SET	WITH OIL SEAL FOR PLASTIC VALVE COVER	76
66119291	OM926	FULL GASKET SET	WITHOUT OIL SEAL FOR PLASTIC VALVE COVER	76
76136061	OM906	HEAD GASKET SET	WITH OIL SEAL FOR PLASTIC VALVE COVER	76
76139261	OM926	HEAD GASKET SET	WITH OIL SEAL FOR PLASTIC VALVE COVER	76
76114682	OM612	FULL GASKET SET	WITH OIL SEAL WITH REAR FLANGE	78
76134682	OM612	HEAD GASKET SET	WITH OIL SEAL	78
76112702	OM651	FULL GASKET SET	WITH OIL SEAL	80
76132702	OM651	HEAD GASKET SET	WITH OIL SEAL	80
76114735	OM501(ENGINE 012091 UP TO 084423)	FULL GASKET SET	WITH OIL SEAL WITHOUT LINER RING	82
76114745	OM501(ENGINE 084424 UP TO 155295)	FULL GASKET SET	WITH OIL SEAL WITHOUT LINER RING	82
76114715	OM501(ENGINE 155296 UP TO 377748)	FULL GASKET SET	WITH OIL SEAL WITHOUT LINER RING	82
76114725	OM501(AFTER 377749)	FULL GASKET SET	WITH OIL SEAL WITHOUT LINER RING	82

MERCEDES

N° ABR	ENGINE	DESCRIPTION	PAGE
76134735	OM501/502(ENGINE 012091 UP TO 084423)	HEAD GASKET SET WITH OIL SEAL	82
76134745	OM501/502 (ENGINE 084424 UP TO 155295)	HEAD GASKET SET WITH OIL SEAL	82
76134715	OM501/502 (ENGINE 155296 UP TO 377748)	HEAD GASKET SET WITH OIL SEAL	82
76134725	OM501/502 (AFTER 377749)	HEAD GASKET SET WITH OIL SEAL	82
76134730	OM501 (ALL)	BOTTOM GASKET SET WITH OIL SEAL WITHOUT OIL PAN GASKET	82
76134720	OM501 (UP TO 012090)	BOTTOM GASKET SET WITH OIL SEAL WITH SOFT OIL PAN GASKET	82
76134710	OM501 (AFTER 012091)	BOTTOM GASKET SET WITH OIL SEAL WITH RUBBER OIL PAN GASKET	82
76114755	OM502 (012091 UP TO 084423)	FULL GASKET SET WITH OIL SEAL WITHOUT LINER RING	84
76114765	OM502 (084424 UP TO 155295)	FULL GASKET SET WITH OIL SEAL WITHOUT LINER RING	84
76114775	OM502 (155296 UP TO 377748)	FULL GASKET SET WITH OIL SEAL WITHOUT LINER RING	84
76114785	OM502 (AFTER 377749)	FULL GASKET SET WITH OIL SEAL WITHOUT LINER RING	84
76134735	OM501/502 (012091 UP TO 084423)	HEAD GASKET SET WITH OIL SEAL	84
76134745	OM501/502 (084424 UP TO 155295)	HEAD GASKET SET WITH OIL SEAL	84
76134715	OM501/502 (155296 UP TO 377748)	HEAD GASKET SET WITH OIL SEAL	84
76134725	OM501/502 (AFTER 377749)	HEAD GASKET SET WITH OIL SEAL	84
76134760	OM502 (ALL)	BOTTOM GASKET SET WITH OIL SEAL WITHOUT OIL PAN GASKET	84
76134750	OM502 (UP TO 012090)	BOTTOM GASKET SET WITH OIL SEAL WITH SOFT OIL PAN GASKET	84
76134740	OM502 (AFTER 012091)	BOTTOM GASKET SET WITH OIL SEAL WITH RUBBER OIL PAN GSKET	84

MERCEDES OM 314 4 CYLINDERS 3.8L

N° SET		DESCRIPTION			
66116081		FULL GASKET SET OM 314 WITH CYLINDER HEAD GASKET 98,5MM WITHOUT OIL SEAL	1		
76116081	3435860090	FULL GASKET SET OM 314 WITH CYLINDER HEAD GASKET 98,5MM WITH OIL SEAL	2		
76126081	3435860090	FULL GASKET SET OM 314 WITH CYLINDER HEAD GASKET 100,0MM WITH OIL SEAL	3		
76136081		HEAD GASKET SET OM 314 WITH CYLINDER HEAD GASKET 98,5MM WITH OIL SEAL	4		
N° ABR	N° ORIGINAL	DESCRIPTION			
56108701	3140160220	CYLINDER HEAD GASKET - OM314 / 364 / 364A Ø 98,5 MM	1	1	1
56131803	3640160320	CYLINDER HEAD GASKET - OM314 / 364 / 364A Ø 100,0 MM		1	
56111616	3140160121	VALVE COVER GASKET	1	1	1
56112616	3141420180	EXHAUST MANIFOLD GASKET	1	1	1
86115759	3145860201	OIL PAN KIT (4 PARTS)		1	1
56110359	3520150320	FRONT COVER GASKET		1	1
56134894	3430150080	REAR COVER GASKET		1	1
50051167	0009979641	GASKET (2 PARTS)		1	1
RE01810S		FRONT CRANKSHAFT GASKET		1	1
56100298	3211310279	CYLINDER HEAD GASKET		1	1
56100590	3522030680	WATER PUMP HOUSING GASKET	2	2	2
56100890	71511022006	WATER PIPE GASKET		1	1
56102690	0000911280	FUEL PUMP GASKET		1	1
56106450	3520180180	OIL COOLER GASKET		1	1
56106595	3120760279	INJECTOR PUMP GASKET		1	1
56106794	3211310079	AIR COMPRESSOR GASKET		1	1
56109090	3271840280	OUTLET EXHAUST GASKET		1	1
56109398	3522010980	WATER PUMP SUPPORT GASKET		1	1
56109498	3522010480	WATER PUMP COVER GASKET		1	1
56109598	3522030080	WATER PUMP HOUSING GASKET	2	2	2
56109698	3522030480	THERMOSTAT GASKET	1	1	1
56109798	3522030780	THERMOSTAT GASKET	1	1	1
56110116	071511060004	OUTLET EXHAUST GASKET		1	1
56110450	3120150680	REAR COVER GASKET		1	1
56111590	3420150080	OIL COOLER COVER GASKET		1	1
56111850	3140150622	SIDE VALVE COVER GASKET		1	1
56112398	3140160280	OIL NOZZLE JOIN GASKET	1	1	1
56114190	3141840379	OUTLET EXHAUST GASKET		1	1
60011680		KIT WASHERS		1	1
86101646		KIT RUBBERS		1	1
86149640		HEAD KIT WASHERS AND RUBBERS	1		

• SOLD SEPARATELY

APPLICATION

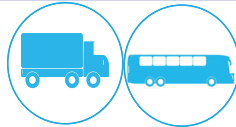

MERCEDES TRUCK 608D/708D 1981/89

BUS LO 608 1972/76

MERCEDES OM 314 4 CYLINDERS 3.8L

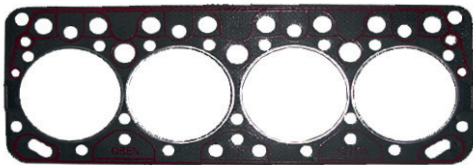

56108701-THCKNESS 98.5MM
56131803-THCKNESS 100 MM

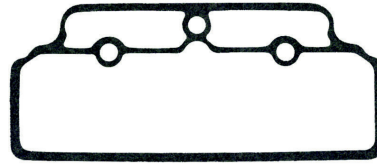

56111616

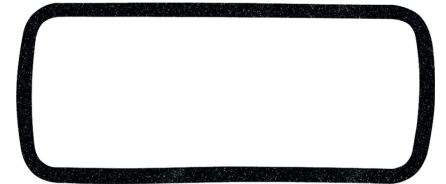

56111850

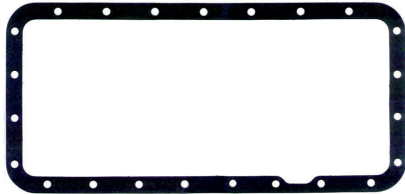

56111590



86115759



56134894



56112616



56110359



56100298



56110450



56106595



56106794



56109498



56109798



56100590



56102690



56100890



56109698



56110116



56109598



56109398



56109090



56114190



56106450



RE01810S



56112398



50051167

60011680		KIT WASHERS	
Nº ABR	DESCRIPTION		QTD
50012128	ALUMINUM WASHER 8,3 X 13,8 X 1,0MM		5
50014123	COPPER WASHER 9,5 X 20,0 X 1,0MM		4
50021229	ALUMINUM WASHER 14,0 X 13,8 X 1,5MM		2
50023329	ALUMINUM WASHER 16,20 X 22,0 X 1,5MM		2
50030425	ALUMINUM WASHER 26,0 X 32,0 X 2,0MM		2
50069329	ALUMINUM WASHER 20,2 X 24,0 X 1,5MM		1
50029723	PAIR WASHER 8,0 X 12,0 X 1,0MM		4

86101646		KIT RUBBERS	
Nº ABR	DESCRIPTION		QTD
50005341	VADADOR 8,0 X 2,7MM		1
50035341	OIL SEAL 31,5 X 3,8MM		4
50035441	WASHER RUBBER 14,0 X 6,0 X 8,0MM		5
54386740	OIL SEAL 12,5 X 2,6MM		1

86149640		HEAD KIT WASHERS AND RUBBERS	
Nº ABR	DESCRIPTION		QTD
50035441	OIL SEAL 6,0 X 14,0 X 8,0MM		5
50014123	COPPER WASHER 9,5 X 20,0 X 1,00MM		4
56129723	PAIR WASHER 8,0 X 12,0 X 1,00MM		4
50035341	OIL SEAL 31,5 X 3,8MM		4

MERCEDES OM 364 4 CYLINDERS 4.0L / OM 364A 4.0L TURBO

N° SET		DESCRIPTION				
76121681		FULL GASKET SET OM 364 WITH CYLINDER HEAD GASKET 98,5MM WITH OIL SEAL				1
76111681		FULL GASKET SET OM 364 WITH CYLINDER HEAD GASKET 100,0MM WITH OIL SEAL				2
76121671		FULL GASKET SET OM 364A WITH CYLINDER HEAD GASKET 98,5MM WITH OIL SEAL				3
76111671		FULL GASKET SET OM 364A WITH CYLINDER HEAD GASKET 100,0MM WITH OIL SEAL				4
76131671		HEAD GASKET SET OM 364 / OM 364A WITH CYLINDER HEAD GASKET 98,5MM WITH OIL SEAL				5
76131681		HEAD GASKET SET OM 364 / OM 364A WITH CYLINDER HEAD GASKET 100,0MM WITH OIL SEAL				6
N° ABR	N° ORIGINAL	DESCRIPTION				
56108701 •	3640160320	CYLINDER HEAD GASKET OM314 / 364 / 364A Ø 98,5 MM	1	1	1	1
56131803 •	3640160320	CYLINDER HEAD GASKET OM314 / 364 / 364A Ø 100,0 MM	1	1	1	1
56131016 •	3640160021	VALVE COVER GASKET	1	1	1	1
56131231 •	3661420180	EXHAUST MANIFOLD GASKET	3	3	3	3
56134716 •		OUTLET EXHAUST GASKET			1	1
86115759 •	3145860201	OIL PAN KIT (4 PARTS)			1	1
56126598 •	3520150520	COMPRESSOR GASKET			1	1
50051167	0009979641	GASKET (2 PARTS)			1	1
RE01810S •		REAR CRANKSHAFT GASKET			1	1
56100590 •	3522030680	WATER PUMP HOUSING GASKET	2	2	2	2
56100890	71511022006	WATER PIPE GASKET			1	1
56102690	000911280	FUEL PUMP GASKET			1	1
56106595 •	3120760279	INJECTOR PUMP GASKET			1	1
56106794 •	3211310079	AIR COMPRESSOR GASKET			1	1
56109498 •	3522010480	WATER PUMP COVER GASKET			1	1
56110450	3120150680	REAR COVER GASKET			1	1
56111590 •	3420150080	OIL COOLER COVER GASKET			1	1
56114190 •	3141840379	OUTLET EXHAUST GASKET			1	1
56127695 •	3141840179	OIL FILTER GASKET			1	1
56128416 •	3521310280	CYLINDER HEAD GASKET (MODERN)			1	1
56129490 •	3662030080	THERMOSTATS GASKET	1	1	1	1
56131316 •	3661410280	INTAKE MANIFOLD GASKET	2	2	2	2
56131941 •	3640150160	SIDE VALVE COVER GASKET			1	1
56133590	3460180080	TURBOCHARGING GASKET			1	1
56134894 •	3430150080	REAR COVER GASKET			1	1
56139316	3521310380	CYLINDER HEAD GASKET			1	1
56148390		OIL COOLER GASKET			2	2
56148698	3641880080	INTKE MSNIFOLD GASKET			1	1
56149198	3030180079	GASKET GUIDE TUBE TO OIL PAN			1	1
60011680		KIT WASHERS			1	1
86101646		KIT RUBBERS			1	1
86120831 •		KIT TURBOCHARING			1	1
86149640		HEAD KIT WASHERS AND RUBBERS	1	1		

•SOLD SEPARATELY

MERCEDES OM 364 4 CYLINDERS 4.0L / OM 364A 4.0L TURBO

APPLICATION

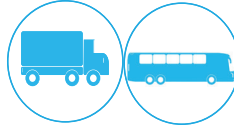

MERCEDES OM364 TRUCK 709 1981/98;

MERCEDES OM364A TRUCK 712 1995/99 ; 912 1987/95 ; 914 1994/99 ; 712 1992/03 ; 710 1992/12 ; 1214C 1997/99 ; 1114 1994/97

MERCEDES OM364A BUS LO 610 2001/03 ; LO 712 2006/10 ; LO 812 1988/10 ; LO 813 1990/96 ; LO 814 1996/04 ; OF 812 1987/97

MERCEDES OM364 BUS LO 809 1991/94

MERCEDES OM 364 4 CYLINDERS 4.0L / OM 364A 4.0L TURBO

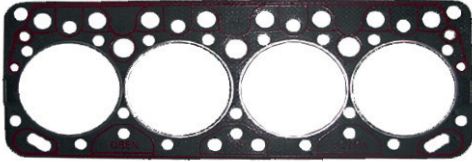

56108701-THCKNESS 98.5MM

56131803-THCKNESS 100 MM

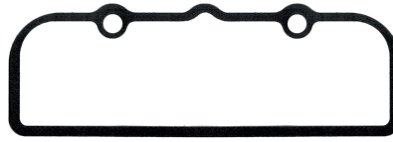

56131016



56131941

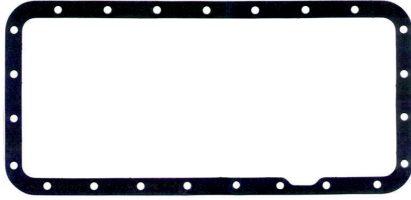

56111590



86115759



56134894



56126598

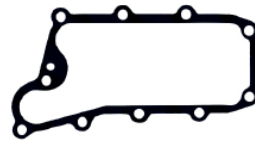

56148698



56106595



56131231



56128416



56131316



56109498



56130990



56100890



56100590



56134716



56106595



56102690



56133590



56129490



56127695



56114190



56109090



56110450



RE01810S



50051167

MERCEDES OM 364 4 CYLINDERS 4.0L / OM 364A 4.0L TURBO

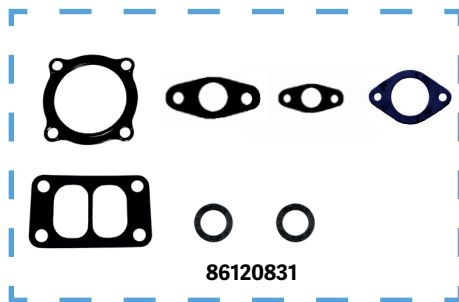

60011680		KIT WASHERS	
N° ABR	DESCRIPTION	QTD	
50012128	ALUMINUM WASHER 8,3 X 13,8 X 1,0MM	5	
50014123	COPPER WASHER 9,5 X 20,0 X 1,0MM	4	
50021229	ALUMINUM WASHER 14,0 X 13,8 X 1,5MM	2	
50023329	ALUMINUM WASHER 16,20 X 22,0 X 1.5MM	2	
50030425	ALUMINUM WASHER 26,0 X 32,0 X 2,0MM	2	
50069329	ALUMINUM WASHER 20,2 X 24.0 X 1,5MM	1	
50029723	PAIR WASHER 8,0 X 12.0 X 1.0MM	4	

86101646		KIT RUBBERS	
N° ABR	DESCRIPTION	QTD	
50005341	OIL SEAL 8,0 X 2,7MM	1	
50035341	OIL SEAL 31,5 X 3,8MM	4	
50035441	WASHER RUBBER 14,0 X 6,0 X 8,0MM	5	
54386740	OIL SEAL 12,5 X 2,6MM	1	

86149640		HEAD KIT WASHERS AND RUBBERS	
N° ABR	DESCRIPTION	QTD	
50035441	OIL SEAL 6,0 X 14,0 X 8,0 MM	5	
50014123	COPPER WASHER 9,5 X 20,0 X 1,0MM	4	
56129723	PAIR WASHER 8,0 X 12,0 X 1,0MM	4	
50035341	OIL SEAL 31,5 X 3,8 MM	4	

N° SET		DESCRIPTION				
76141721		FULL GASKET SET OM 352 WITH CYLINDER HEAD GASKET 98,5MM WITH OIL SEAL				1
76121721		FULL GASKET SET OM 352 WITH CYLINDER HEAD GASKET 100,0MM WITH OIL SEAL				2
76141031		FULL GASKET SET OM 352A/LA WITH CYLINDER HEAD GASKET 98,5MM WITH OIL SEAL				3
76121031		FULL GASKET SET OM 352A/LA WITH CYLINDER HEAD GASKET 100,0MM WITH OIL SEAL				4
76131721		HEAD GASKET SET 352A/LA WITH CYLINDER HEAD GASKET 98,5MM WITH OIL SEAL				5
76131031		HEAD GASKET SET 352A/LA WITH CYLINDER HEAD GASKET 100,0MM WITH OIL SEAL				6
N° ABR	N° ORIGINAL	DESCRIPTION				
56149603	3520160220	CYLINDER HEAD GASKET OM352 / 352A / 352LA / 366 / 366A / 366LA Ø 98,5 MM	1	1	1	1
56150201	3440167520	CYLINDER HEAD GASKET OM352 / 352A / 352LA / 366 / 366A / 366LA Ø 100 MM	1	1	1	1
56110216	3520160421	VALVE COVER GASKET	1	1	1	1
86115531	3521420080	KIT EXHAUST MANIFOLD GASKET TURBO / ASPIRATED	1	1	1	1
86112159	3445867001	OIL PAN KIT		1	1	1
56110359	3520150320	VALVE COVER GASKET		1	1	1
56134894	3430150080	REAR COVER GASKET		1	1	1
50051167	0009979641	GASKET (2 PARTS)		1	1	1
RE01810S		FRONT CRAKSHAFT GASKET		1	1	1
56100298	3211310279	COMPRESSOR CYLINDER HEAD GASKET 77 MM		1	1	1
56100890	71511022006	WATER PIPE GASKET		1	1	1
56101216	302490080	OUTLET EXHAUST GASKET		1	1	
56102690	0000911280	FUEL PUMP GASKET		1	1	1
56106056	3520150522	SIDE VALVE COVER GASKET		1	1	1
56106450	3120180280	OIL COOLER GASKET		1	1	1
56106595	3120760279	INJECTOR PUMP GASKET		1	1	1
56106794	3211310079	AIR COMPRESSOR GASKET		1	1	1
56107716	3124921080	OUTLET EXHAUST GASKET				1
56109090	3271840280	OUTLET EXHAUST GASKET		1	1	1
56109398	3522010980	WATER PUMP SUPPORT GASKET		1	1	1
56109498	3522010480	WATER PUMP COVER GASKET		1	1	1
56110450	3120150680	REAR COVER GASKET		1	1	1
56112298	3522011280	WATER PUMP GASKET		1	1	1
56114190	3141840379	OUTLET EXHAUST GASKET		1	1	1
56128416	3521310280	CYLINDER HEAD GASKET - 94 MM		1	1	1
56139398	3521310380	CYLINDER HEAD GASKET		1	1	1
56149098	3520180380	COMPRESSOR GASKET		1	1	1
60011720		WASHERS KIT		1	1	1
86111175	445860018	OIL COOLER GASKET KIT		1	1	1
86120831		TURBOCHARING GASKET KIT		1	1	
86124390		WATER COOLER GASKET KIT	1	1	1	1
SK861044		KIT RUBBERS		1	1	1
86149726		HEAD WASHER KIT	1	1		
86149740		HEAD KIT RUBBERS	1	1		

• SOLD SEPARATELY

APPLICATION

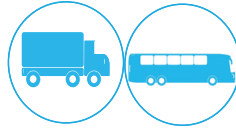

MERCEDES OM352 TRUCK 1114 1981/90 ; 1113 1970/87 ; 1313/1513/2013 1970/89 ; 2213 1971/89;

MERCEDES OM352A/LA TRUCK 2014 1975/89 ; 1514 1979/89 ; 1117 1981/90 ; 1316/1317/1516 1981/89 ; 1517 1986/87 ; 1518/2018 1981/91; 2216/2217 1981/87 ;

MERCEDES OM352 BUS O 364 1978/84 ; OF 1113 1980/81 ; OF 1313/OH 1313 1970/86 ; OF 1314 1987/87

MERCEDES OM352A/LA BUS O 365 1986/89 ; OF 1316 1982/86

MERCEDES OM 352 / OM 352A / OM 352LA 6 CYLINDERS 5.7L

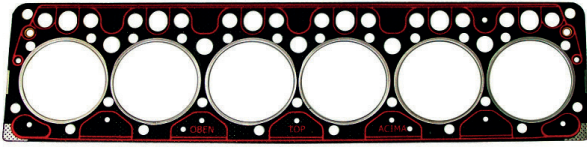

56149603-THCKNESS 98.5MM

56150201-THCKNESS 100 MM

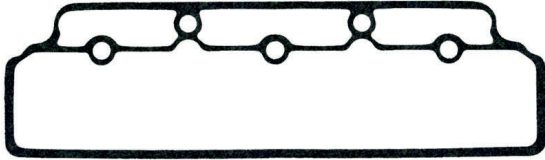

56110216



56106056

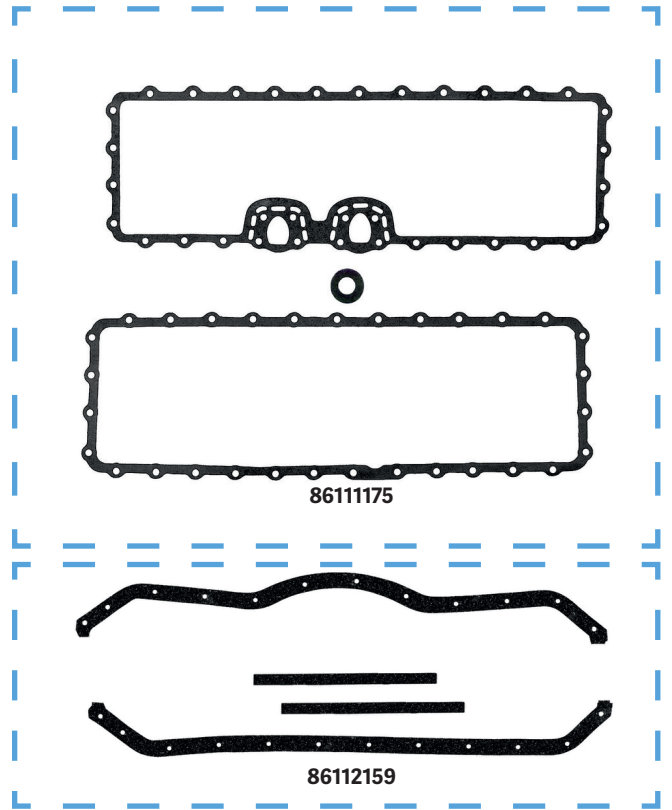

86111175

86112159

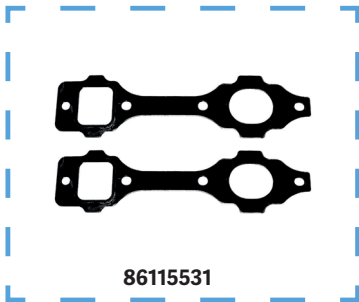

86115531



56110359



56126598



56134894



56128416



56100298



56106595



56109498



56101217



56107716



56149098



56106794



56102690



56110450



56112298

MERCEDES OM 352 / OM 352A / OM 352LA 6 CYLINDERS 5.7L

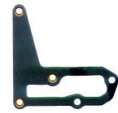

56109398



56109090



56114190



RE01810S



56106450



50051167

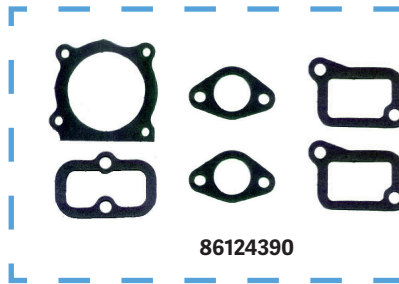

86124390

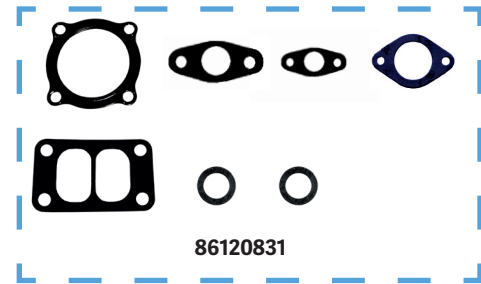

86120831

86149740 HEAD KIT RUBBERS		
N° ABR	DESCRIPTION	QTD
50035441	OIL SEAL 6,0 X 14,0 X 8,0 MM	7
50035341	OIL SEAL 31,5 X 3,8 MM	6

86149726 HEAD KIT WASHER		
N° ABR	DESCRIPTION	QTD
50014123	COPPER WASHER 9,5 X 20,0 X 1,0MM	6
56129723	PAIR WASHER 8,0 X 12,0 X 1,0MM	6

60011720 HEAD KIT WASHER		
N° ABR	DESCRIPTION	QTD
	ALUMINUM WASHER 26,2X32,0X1,5 MM	1
50011238	STEEL WASHER 8,0 X 12,0 X 1,0 MM	16
50011428	ALUMINUM WASHER 8,1 X 13,8 X 1,0 MM	6
50013860	WASHER 9,0 X 18,0 X 0,4 MM	4
50014123	COPPER WASHER 9,5 X 20,0 X 1,0 MM	6
50015428	ALUMINUM WASHER 10,2 X 14,0 X 1,0 MM	6
50021129	ALUMINUM WASHER 14,0 X 18,0 X 1,5 MM	1
50021229	ALUMINUM WASHER 14,0 X 20,0 X 1,5 MM	18
50023329	ALUMINUM WASHER 16,2 X 22,0 X 1,5 MM	6
50025424	COPPER WASHER 18,3 X 23,8 X 1,5 MM	2
	ALUMINUM WASHER 24,3 X 30,0 X 1,5 MM	1
50030425	ALUMINUM WASHER 26,0 X 32,0 X 2,0 MM	1
50069229	ALUMINUM WASHER 18,2 X 21,9 X 1,5 MM	3
50072429	ALUMINUM WASHER 22,5 X 26,7 X 1,5 MM	1
56129723	PAIR WASHER 8,0 X 12,0 X 1,0 MM	6

SK861044 KIT RUBBERS		
N° ABR	DESCRIPTION	QTD
	OIL SEAL 30,80X3,70MM	6
	OIL SEAL 62,00X3,00MM	1
	OIL SEAL 28,30X2,00MM	1
	OIL SEAL 8,30X2,50MM	1
	OIL SEAL 13,10X2,62MM	1
	OIL SEAL 115,00X5,00MM	1
	OIL SEAL 105,00X95,00X3,00MM	1
	OIL SEAL 14,00X6,00X8,00MM	7
	OIL SEAL 23,70X14,20X6,30MM	1
	OIL SEAL 27,90X13,80X10,50MM	1

MERCEDES OM 355/5 CYLINDERS 20V 9.7L

N° SET		DESCRIPTION			
66113121 3555860290		FULL GASKET SET OM 355/5 CYLINDERS ASPIRADO / TURBO WITHOUT OIL SEAL	1		
76113121 3555860290		FULL GASKET SET OM 355/5 CYLINDERS ASPIRADO / TURBO WITH OIL SEAL	2		
76133121		HEAD GASKET SET OM 355/5 CYLINDERS ASPIRADO / TURBO WITH OIL SEAL	3		
N° ABR	N° ORIGINAL	DESCRIPTION			
56111903	3550160220	CYLINDER HEAD GASKET – OM 355 3 CYLINDERS Ø 133MM	1	1	1
56119803	3450160020	CYLINDER HEAD GASKET – OM 355 2 CYLINDERS Ø 133MM	1	1	1
56123503	3460160320	CYLINDER HEAD GASKET – OM 355 1 CYLINDERS Ø 133MM			
RE01860N		INJECTOR PUMP GASKET		1	
56111796	3460160022	VALVE COVER GASKET	5	5	5
86137816		INTAKE MANIFOLD GASKETS KIT - 5 CYLINDERS	1	1	1
86119790		OIL PAN KIT – OM 355 5 CYLINDERS		1	1
56116359	3460150120	REAR COVER GASKET		1	1
RE00269S		DISTRIBUTION SEAL		1	
RE01815F		VALVE STEM SEAL	20	20	
54117583	3043340059	DRIVE AXLE SHAFT FLANGE GASKET		1	1
56101139	3451420080	EXHAUST MANIFOLD GASKET	5	5	5
56101216	3024900080	OUTLET EXHAUST GASKET		1	1
56101317	3444920080	OUTLET EXHAUST GASKET		1	1
56101490	3151840180	COVER OIL FILTER GASKET		1	1
56101590	3262030080	WATER PUMP GASKET		1	1
56101790	3152010180	COVER WATER PUMP GASKET		1	1
56102294	0651810079	SUPPORT OIL PUMP GASKET		1	1
56113950	3520180180	COVER PIPE OIL GASKET		1	1
56117890	3562010180	WATER PUMP COVER GASKET		1	1
56118090	3551840480	SUPPORT OIL FILTER GASKET		1	1
56118190	3551880080	OIL COOLER HOUSING GASKET		1	1
56118290	0001311679	AIR COMPRESSOR GASKET (HEAD)		1	1
56118390	0001311579	AIR COMPRESSOR GASKET (BOTTOM)	2	2	
56118416	0001314380	COMPRESSOR GASKET		1	1
56118590	0011311479	SUPPORT AIR COMPRESSOR GASKET		1	1
56118690	3460770380	SUPPORT INJECTOR PUMP GASKET	2	2	
56118990	071511040017	WATER PIPE GASKET		1	1
56119090		BREATHER PIPE GASKET		6	6
56119290	0000911280	FUEL PUMP GASKET		1	1
56119690	3540150021	CYLINDER COVER GASKET OM 355 5		1	1
56120190	071511026003	OIL COOLER GASKET		1	1
56122298	3450150022	SIDE VALVE COVER GASKET		1	1
56133590	3460180080	TUBOCHARGING GASKET		1	1
60013120		KIT WASHERS 5 CYLINDERS		1	1
83721017		KIT TURBINE GASKET		1	1
86100846		KIT RUBBERS 5 CYLINDERS		1	1
86117690	0001303920	KIT AIR COMPRESSOR GASKET		1	1
86130890		KIT WATER COOLER GASKET	1		
86149940		HEAD KIT WASHERS RUBBERS OM 355 / 5 CYLINDERS	1		

• SOLD SEPARATELY

MERCEDES OM 355/5 CYLINDERS 20V 9.7L

APPLICATION

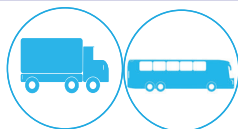

MERCEDES TRUCK 1519 1973/89 ; 1520 1981/90 ; 2220 1987/91 ; 2219 1977/89 ; 1525 1985/90 ; 2225 1989/89

MERCEDES BUS O 364 1978/86 ; O 370R 1984/87 ; O371 R 1987/90 ; O 371 UP 1987/93 ; OH 1419/OH 1517 1976/86

MERCEDES OM 355/5 CYLINDERS 20V 9.7L



56111903 - THCKNESS 133MM



56119803 - THCKNESS 133MM

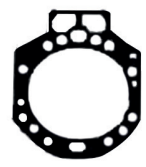

56123503 - THCKNESS 133MM

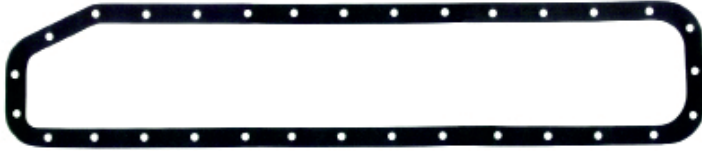

56119690

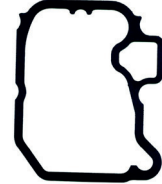

56111796

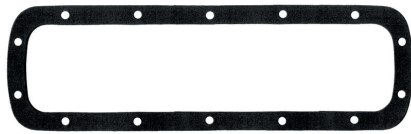

56117990

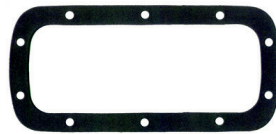

56122298

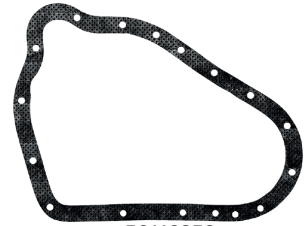

56116359

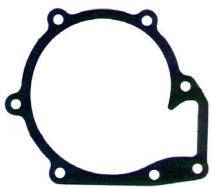

56117890

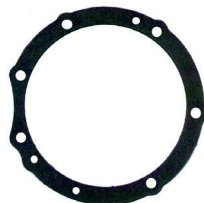

56118690



54117583

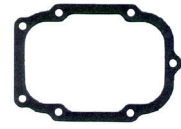

56118190



56119090



56118990



56102294



56101139



56101216



56101317



56101590



56133590



56119190



56118390



5618290



56119290



56118416



56101490



RE00269S



RE01860N



56118090



56113950



RE01815F

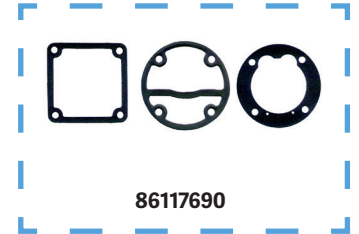
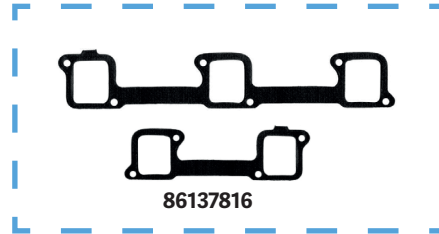
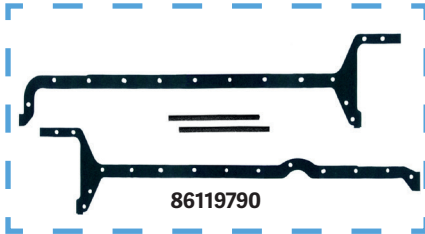

60013120		KIT WASHER	
N° ABR	DESCRIPTION		QTD
50034920	COPPER WASHER 35,3 X 41,0 X 2,0MM		7
56129723	PAIR WASHER 8,0 X 12,0 X 1,0MM		5
50032729	ALUMINUM WASHER 30,3 X 35,9 X 1,50MM		2
50012128	ALUMINUM WASHER 8,3 X 13,8 X 1,0MM		15
50012928	ALUMINUM WASHER 8,3 X 11,4 X 1,0MM		12
50021229	ALUMINUM WASHER 14,0 X 20,0 X 1,5MM		12
50072429	ALUMINUM WASHER 22,5 X 26,7 X 1,5MM		6
50027329	ALUMINUM WASHER 20,5 X 25,9 X 1,50MM		2
50070329	ALUMINUM WASHER 18,5 X 21,7 X 1,5MM		2
50023329	ALUMINUM WASHER 16,2 X 22,0 X 1,5MM		2
50029525	ALUMINUM WASHER 24,2 X 29,4 X 2,0MM		2
50021429	ALUMINUM WASHER 14,2 X 18,0 X 1,50MM		1
50014123	COPPER WASHER 9,5 X 20,0 X 1,0MM		5

86100846		KIT RUBBERS	
N° ABR	DESCRIPTION		QTD
50007841	OIL SEAL 27,0X3,3MM		2
50028441	OIL SEAL 117,0X4,8MM		1
50035341	OIL SEAL 30,8X3,7MM		5
54386740	OIL SEAL 12,5X2,6MM		1
50040041	OIL SEAL 18,0X2,5MM		1
50002841	COOLER TUBE		5
50003041	INTAKE MANIFOLD		1

86149940		KIT RUBBERS	
N° ABR	DESCRIPTION		QTD
56129723	PAIR WASHER 8,0 X 12,0 X 1,0MM		5
50014123	COPPER WASHER 9,5 X 20,0 X 1,0MM		5
50002841	COOLER SEAL RING		5
50003041	COOLING PIPE RING		1

N° SET		DESCRIPTION			
66112501 3555860290		FULL GASKET SET OM 355/6 CYLINDERS ASPIRATED / TURBO WITHOUT OIL SEAL	1		
76112501 3555860290		FULL GASKET SET OM 355/6 CYLINDERS ASPIRATED / TURBO WITH OIL SEAL	2		
76132501		HEAD GASKET SET OM 355/6 CYLINDERS ASPIRATED / TURBO WITH OIL SEAL	3		
N° ABR	N° ORIGINAL	DESCRIPTION			
56111903	3550160220	CYLINDER HEAD GASKET – OM 355 3 CYLINDERS Ø 133MM	2	2	2
56123503	3460160320	CYLINDER HEAD GASKET – OM 355 1 CILINDRO Ø 133MM			
56111796	3460160022	VALVE COVER GASKET	6	6	6
86137716		INTAKE MANIFOLD GASKETS KIT 6 CYLINDERS	1	1	1
86116190		OIL PAN KIT – OM 355 6 CYLINDERS		1	1
56116359	3460150120	REAR COVER GASKET		1	1
RE00269S		REAR CRANKSHAFT OIL SEAL		1	
RE01815F		VALVE STEM SEAL	24	24	
RE01860N		INJECTOR PUMP GASKET		1	
54117583	3043340059	DRIVE AXLE SHAFT FLANGE GASKET		1	1
56101139	3451420080	INTAKE MANIFOLD GASKET	6	6	6
56101216	3024900080	OUTLET EXHAUST GASKET		1	1
56101317	3444920080	OUTLET EXHAUST GASKET		1	1
56101490	3151840180	COVER OIL FILTER GASKET		1	1
56101590	326.2030080	WATER PUMP GASKET		1	1
56101790	3152010180	COVER WATER PUMP GASKET		1	1
56102294	0651810079	SUPPORT OIL PUMP GASKET		1	1
56113950	3520180180	COVER PIPE OIL GASKET		1	1
56117790	3560150121	COVER CYLINDERS GASKET OM 355 6 CYLINDERS		1	1
56117890	3562010180	WATER PUMP COVER GASKET		1	1
56117990	3550150022	SIDE VALVE COVER GASKET		1	1
56118090	3551840480	SUPPORT OIL FILTER GASKET		1	1
56118190	3551880080	OIL COOLER HOUSING GASKET		1	1
56118290	0001311679	AIR COMPRESSOR GASKET (HEAD)		1	1
56118390	0001311579	AIR COMPRESSOR GASKET (BOTTOM)		2	2
56118416	0001314380	CYLINDER HEAD GASKET		1	1
56118590	0011311479	SUPPORT AIR COMPRESSOR GASKET		1	1
56118690	3460770380	SUPPORT INJECTOR PUMP GASKET		2	2
56118990	071511040017	BREATHER PIPE GASKET		1	1
56119090		BREATHER PIPE GASKET		6	6
56119190	3030180079	PIPE OIL PUMP GASKET		1	1
56119290	0000911280	FUEL PUMP GASKET		1	1
56120190	071511026003	OIL COOLER GASKET		1	1
56133590	3460180080	TUBOCHARGING GASKET		1	1
60012500		KIT WASHERS 6 CYLINDERS		1	1
83721017		KIT TURBINE GASKET		1	1
86100946		KIT RUBBERS 6 CYLINDERS		1	1
86117690	0001303920	KIT AIR COMPRESSOR GASKET		1	1
86130890		KIT WATER COOLER GASKET		1	
86149840		HEAD KIT WASHERS RUBBER OM 355 / 6 CYLINDERS		1	

• SOLD SEPARATELY

MERCEDES OM 355/6 CYLINDERS 24V 11.6L

APPLICATION



MERCEDES TRUCK 1524 1985/89 ; 1924 1974/87 ; 2624 1974/...1525 1985/90 ; 2225 1989/89 ; 929 1984/87 ; 1932/1933 1984/89 1934 1987/89 ;

MERCEDES BUS O 355 1972/75 ; O 370 RS/O 370 RSD 1976/90 ; OH 1420 1972/86

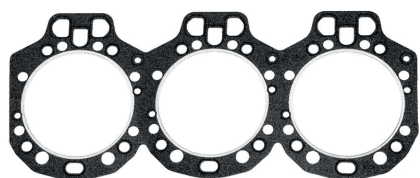

56111903 - THCKNESS 133 MM

56123503 - THCKNESS 133 MM

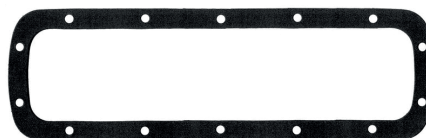

56117990



56111796



56117790



54117583

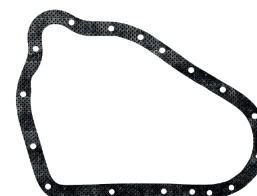

56116359



56118690



56123503

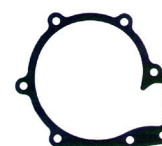

56117890



56118390



56118290

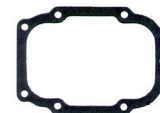

56118190



56118990



56119090



56119190



56120190



56102294



56101139



56101216



56118090



56101590



56119290



56118416



56133590



561011490



56113950



RE00269S



RE01860N



RE01815F

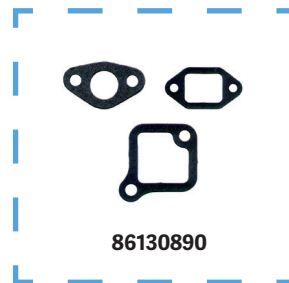
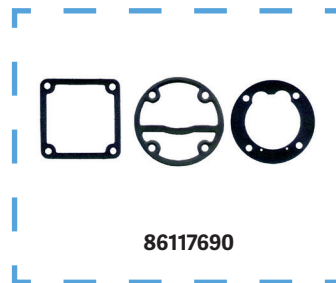
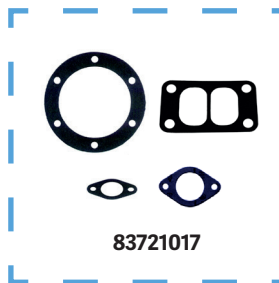
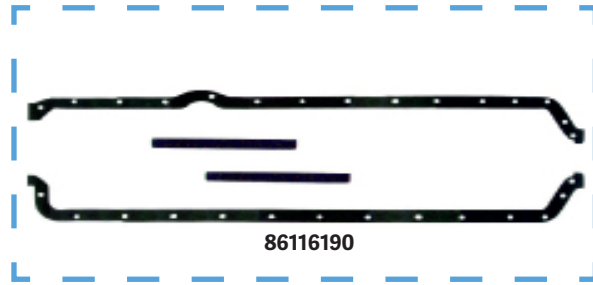
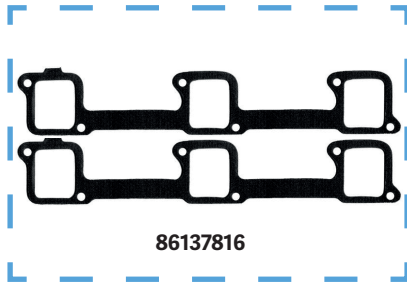

60012500		KIT WASHERS	
N° ABR	DESCRIPTION		QTD
50034920	COPPER WASHER 35,3 X 41,0 X 2,0MM		7
56129723	PAIR WASHER 8,0 X 12,0 X 1,0MM		6
50032729	ALUMINUM WASHER 30,3 X 35,9 X 1,50MM		2
50012128	ALUMINUM WASHER 8,3 X 13,8 X 1,0MM		18
50012928	ALUMINUM WASHER 8,3 X 11,4 X 1,0MM		14
50021229	ALUMINUM WASHER 14,0 X 20,0 X 1,5MM		14
50092728	ALUMINUM WASHER 12,5 X 15,9 X 1,0MM		6
50072429	ALUMINUM WASHER 22,5 X 26,7 X 1,5MM		6
50027329	ALUMINUM WASHER 20,5 X 25,9 X 1,50MM		2
50070329	ALUMINUM WASHER 18,5 X 21,7 X 1,5MM		2
50023329	ALUMINUM WASHER 16,2 X 22,0 X 1,5MM		2
50029525	ALUMINUM WASHER 24,2 X 29,4 X 2,0MM		2
50021429	ALUMINUM WASHER 14,2 X 18,0 X 1,50MM		2
50014123	COPPER WASHER 9,5 X 20,0 X 1,0MM		6

86149840		HEAD KIT WASHERS RUBBERS	
N° ABR	DESCRIPTION		QTD
56129723	PAIR WASHER 8,0 X 12,0 X 1,0 MM		6
50014123	COPPER WASHER 9,5 X 20,0 X 1,0 MM		6
50002841	COOLING PIPE RING		6
50003041	INTAKE MANIFOLD SEALER		1

MERCEDES OM 366 CYLINDERS 6.0L /366A/366LA 6 CYLINDERS 6.0L TURBO

Nº SET	DESCRIPTION
76121691 445800095	FULL GASKET SET OM 366 WITH CYLINDER HEAD GASKET 98,5MM WITH OIL SEAL 1
76111691 445800095	FULL GASKET SET OM 366 WITH CYLINDER HEAD GASKET 100,0MM WITH OIL SEAL 2
76121701	FULL GASKET SET OM 366A WITH CYLINDER HEAD GASKET 98,5MM WITH OIL SEAL 3
76141701	FULL GASKET SET OM 366A WITH CYLINDER HEAD GASKET 100,0MM WITH OIL SEAL 4
761212791	FULL GASKET SET OM 366LA WITH CYLINDER HEAD GASKET 100,0MM WITH OIL SEAL 5
76131701	HEAD GASKET SET 366/A/LA WITH CYLINDER HEAD GASKET 98,5MM WITH OIL SEAL 6
76131691	HEAD GASKET SET 366/A/LA WITH CYLINDER HEAD GASKET 100,0MM WITH OIL SEAL 7

Nº ABR	Nº ORIGINAL	DESCRIPTION	1	2	3	4	5	6	7
56149603	35201602.20	CYLINDER HEAD GASKET OM352 / 352A / 352LA /366 / 366A / 366LA Ø 98,5 MM		1			1		1
56150201	3440167520	CYLINDER HEAD GASKET OM352 / 352A / 352LA / 366 / 366A / 366LA Ø 100,0 MM	1		1	1		1	
56130516	3660160021	VALVE COVER GASKET	1	1	1	1	1	1	1
56131231	3661420180	EXHAUST MANIFOLD GASKET	4	4	4	4	4	4	4
56131316	3661410280	INTAKE MANIFOLD GASKET	3	3	3	3	3	3	3
86112159	3445867001	OIL PAN KIT			1	1	1	1	1
56151280	3660150020	CAMSHAFT GASKET OM 366 LA PUMP "P"			1				
56170167	3660150020	CAMSHAFT GASKET OM 366 LA PUMP "A"			1				
56126598	3520150520	VALVE COVER GASKET			1	1	1	1	1
50051167	0009979641	GASKET (2 PARTS)			1	1	1	1	1
RE01810S		FRONT CRAKSHAFT GASKET			1	1	1	1	1
56100590	3522030680	WATER PUMP HOUSING GASKET	2	2	2	2	2	2	2
56100890	71511022006	WATER PIPE GASKET			1	1	1	1	1
56102690	0000911280	FUEL PUMP GASKET			1	1	1	1	1
56106595	3120760279	INJECTOR PUMP GASKET			1	1	1	1	1
56106794	3124921080	AIR COMPRESSOR GASKET - IMPORTED			1	1	1	1	1
56109498	3522010480	WATER PUMP COVER GASKET			1	1	1	1	1
56110450	3120150680	FRONT COVER GASKET			1	1	1	1	1
56114190	3141840379	OUTLET EXHAUST GASKET			1	1	1	1	1
56127695	3141840179	OIL FILTER GASKET			1	1	1	1	1
56128416	3521310380	CYLINDER HEAD GASKET (MODERN) 94,0 MM			1	1	1	1	1
56129490	3662030080	THERMOSTATIC GASKET	1	1					
56129532	3622010080	WATER PUMP GASKET			1	1	1	1	1
56130616	3504920080	OUTLET EXHAUST GASKET			1	1	1	1	1
56130990	3440160080	OIL FILTER GAP GASKET			1	1	1	1	1
56131141	3520150160	SIDE VALVE COVER GASKET			1	1	1	1	1
56133590	3460180080	TUBOCHARGING GASKET			1	1	1	1	1
56134894	3430150080	REAR COVER GASKET			1	1	1	1	1
56138294	3622010180	WATER PUMP SUPPORT GASKET			1	1	1	1	1
56139398	3521310380	CYLINDER HEAD GASKET			1	1	1	1	1
56143990	3520180980	GASKET GUIDE TUBE TO OIL PAN			1	1	1	1	1
56148390		OIL COOLER GASKET			2	2	2	2	2
56149198	3030180079	GASKET GUIDE TUBE TO OIL PAN			1	1	1	1	1
60011720		KIT WASHERS			1	1	1	1	1
86120831		KIT TURBINE GASKET			1	1	1		
86126675	3621800079	KIT OIL RADIATOR GASKET			1	1	1	1	1
86148940		KIT RUBBERS			1	1	1	1	1
86149740		HEAD KIT WASHERS AND RUBBERS	1	1					

• SOLD SEPARATELY

APPLICATION



MERCEDES 366 TRUCK 2217 1987/90 ; 1314/2216 1987/89 ; 1214 1989/96 ; 1714 1991/96 ; 1414/1614 1989/96 ; 2214 1987/89 2314 1990/94 ;
MERCEDES 366A TRUCK 1218 1989/00 ; 1318 1989/03 ; 1118 1987/90 ; 2318/2418 1990/99 ; 1718 1991/99 ; 1618 1981/96 ; 1418 1989/00
MERCEDES 366LA TRUCK 1721 1991/98 ; 1621 1987/97 ; 1420 2002/05 ; 1720 1997/06 ; 1723 1997/01 ; 1620 1993/05
MERCEDES 366 BUS OF 1315 1988/94 ; O 371 ST 1988/94 ; OH 1315 1988/95 ; OF 1115 1988/92
MERCEDES 366A BUS O 371 U 1987/94 ; OF 1618 1992/94 ; OH 1318 1988/97 ; OF 1318 1988/07 ; OF 1620 1995/99 ;
OF 1721 1998/05 OH 1420 1998/03 ; OH 1420 1998/03 ; O 371 UL 1994/97 ; OH 1421/OH 1521/OH 1623 LG 1998/04 ; OH 1621/L/LE 1997/05



MERCEDES OM 366 CYLINDERS 6.0L /366A/366LA 6 CYLINDERS 6.0L TURBO

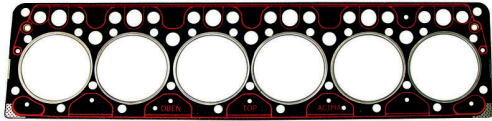

56149603-THCKNESS 98.5MM

56150201-THCKNESS 100 MM



56130516



56131141



56106595



56109498

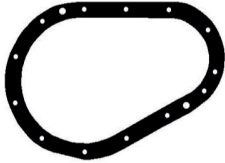

56126598



56151280



56170167



56134894



56130616



56131231



56131316



56143990



56148390



56149198



56100590



58130990



56102690



56128416



56139398



56106794



56110450



56133590



56114190



56127695



56138294



56129490

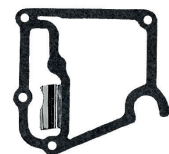

56129532



RE01810S



50051167

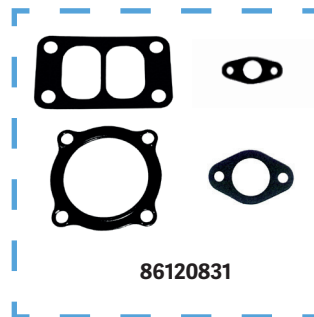
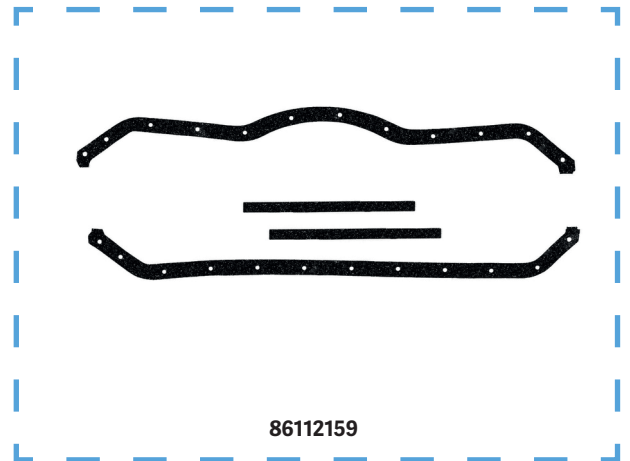
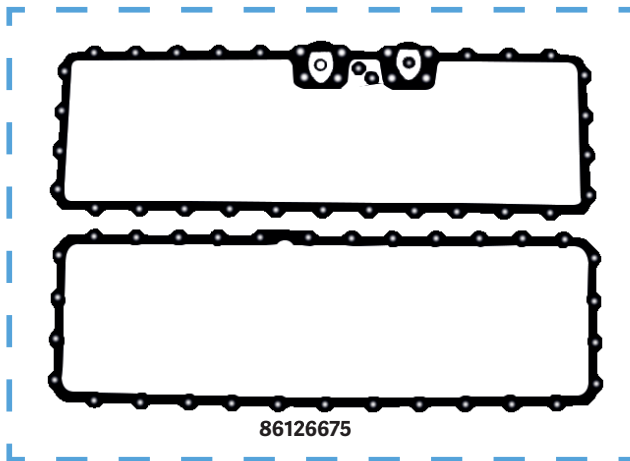

86149740		HEAD KIT WASHERS AND RUBBERS	
N° ABR	DESCRIPTION	QTD	
50014123	PAIR WASHER 8,0 X 12,0 X 1,0MM	6	
56129723	COPPER WASHER 9,5 X 20,0 X 1,0MM	6	
50035441	COOLING PIPE RING	7	
50035341	INTAKE MANIFOLD RING	6	

60011720		HEAD KIT WASHER	
N° ABR	DESCRIPTION	QTD	
	ALUMINUM WASHER 26,2 X 32,0 X 1,5MM	1	
50011238	STEEL WASHER 8,0 X 12,0 X 1,0MM	16	
50011438	ALUMINUM WASHER 8,1 X 13,8 X 1,0MM	6	
50013860	WASHER 9,0 X 18,0 X 0,4MM	4	
50014123	COPPER WASHER 9,5 X 20,0 X 1,0MM	6	
50015428	ALUMINUM WASHER 10,2 X 14,0 X 1,0MM	6	
50021129	ALUMINUM WASHER 14,0 X 18,0 X 1,5MM	1	
50021229	ALUMINUM WASHER 14,0 X 20,0 X 1,5MM	18	
50023329	ALUMINUM WASHER 16,2 X 22,0 X 1,5MM	6	
50025424	COPPER WASHER 18,3 X 23,8 X 1,5MM	2	
	ALUMINUM WASHER 24,3 X 30,0 X 1,5MM	1	
50030425	ALUMINUM WASHER 26,0 X 32,0 X 2,0MM	1	
50069229	ALUMINUM WASHER 18,2 X 21,9 X 1,5MM	3	
50072429	ALUMINUM WASHER 22,5 X 26,7 X 1,5MM	1	
56129723	WASHER PAIR 8,0 X 12,0 X 1,0MM	6	

86148940		KIT RUBBERSS	
N° ABR	DESCRIPTION	QTD	
	RUBBER RING 30,8 X 3,7MM	6	
	RUBBER RING 34,0 X 4,0MM	2	
	RUBBER RING 8,3 X 2,5MM	4	
	RUBBER RING 60 X 4,2MM	1	
	RUBBER RING 45,0 X 4,0MM	2	
	RUBBER RING 13,1 X 2,6MM	1	
	RUBBER RING 28,5 X 2,5MM	1	
	RUBBER RING 62,0 X 3,0MM	1	
	RUBBER RING 75,0 X 3,0MM	1	
	RUBBER RING 101,0 X 4,3MM	2	
	RUBBER RING 14,0 X 7,5MM	7	
	RUBBER RING 14,0 X 23,7 X 6,3MM	1	

Nº SET	DESCRIPTION
76196115	FULL GASKET SET OM 447A/447LA 6 CYL WITH LINER RINGS WITH OIL SEAL
66196115	FULL GASKET SET OM 447A/447LA 6 CYL WITH LINER RINGS WITHOUT OIL SEAL
76196125	FULL GASKET SET OM 449A/449LA 5 CYL WITH LINER RINGS WITH OIL SEAL
66196125	FULL GASKET SET OM 449A/449LA 5 CYL WITH LINER RINGS WITHOUT OIL SEAL
76136125	MONOCYLINDER GASKET SET OM447 / OM449 WITH OIL SEAL
66136125	MONOCYLINDER GASKET SET OM447 / OM449 WITHOUT OIL SEAL

Nº ABR	Nº ORIGINAL	DESCRIPTION					
56137200	4220160420	CYLINDER HEAD GASKET OM447 / OM449	1	1	5	5	6 6
56130490		VALVE COVER GASKET	1	1	5	5	6 6
56139239	4031420380	EXHAUST MANIFOLD GASKET	1	1	5	5	6 6
56141317		INTAKE MANIFOLD GASKET	1	1	5	5	6 6
56151067	4050140222	OIL PAN GASKET OM449 - 5 CYLINDERS			1	1	
56151167	4070140222	OIL PAN GASKET OM447 - 6 CYLINDERS					1 1
56132298	4030110080	FRONT COVER GASKET			1	1	1 1
56142398	4290150080	FRONT COVER GASKET					1 1
RE02697F		ROCKER COVER BOLT SEALER					1 1
RE02696F		FRONT CRAKSHAFT GASKET					1 1
RE02786F		VALVE STEM SEAL		2		10	12
50014123	3460170160	WASHER DO BICO INJETOR	1	1	5	5	6 6
54308398	623208520044	INLET OIL GASKET			1	1	1 1
54308490	623208520064	TURBOCHARING GASKET			1	1	1 1
56128690	4030180180	FULL COVER GASKET			1	1	1 1
56129890	4750980180	AIR INTAKE MANIFOLD TUBE GASKET			1	1	1 1
56130290	4750880280	AIR INTAKE MANIFOLD TUBE GASKET			1	1	1 1
56130390	4422010480	WATER PUMP GASKET			1	1	1 1
56130616	3504920080	OUTLET EXHAUST GASKET			1	1	1 1
56132490	4031840280	OIL RADIADOR GASKET			1	1	1 1
56132590	4032011080	WATER PUMP GASKET			1	1	1 1
56132690	917003040003	FLANGE GASKET			1	1	1 1
56132795	917003036002	OIL PUMP GASKET			1	1	1 1
56132950	4750150180	OUTLET OIL GASKET			1	1	1 1
56141095	4031310780	BOTTOM AIR GASKET			1	1	1 1
56142490	917003026000	OIL COOLER GASKET			2	2	2 2
56145416	4071310780	CYLINDER HEAD AIR GASKET			1	1	1 1
56164640	39975750	INJECTOR HOLDER SEAL	1	1	5	5	6 6
56167940		LINER RING 144X3,8MM	2	2	10	10	12 12
59651490	4071310880	AIR COMPRESSOR CYLINDER HEAD GASKET			1	1	1 1
60086110		KIT WASHERS			1	1	1 1
86149032		KIT LINER RINGS			5	5	6 6

• SOLD SEPARATELY

APPLICATION



MERCEDES TRUCK OM 449A/449LA 5 CYL - 1630 1990/99 ; 1632 1999/02 ; 1625 1989/96 ; 2225 1987/90 ; 2325 1989/00
MERCEDES TRUCK OM 447A/447LA 6 CYL - 1634 2001/05 ; 1934 1984/91 ; 2635 1992/99 ; 1941 1989/97 ; 1935 1989/99 ; 2638/2038 1996/98
MERCEDES BUS OM 449A/449LA 5 CYL O 371 R 1992/97 ; O 371 UP 1990/97 ; O 400 R 1994/97 ; O 400 UP 1995/97 ; O 400 UPA 1995/98 OH 1625/OH 1630 1990/95 ; OH 1628 1998/04
MERCEDES BUS OM 447A/447LA 6 CYL - O 371 RS/O 371 RSD 1990/98 ; O400 RSL/RSD 1994/99 ; O400 RS 1994/03 ; O 400 RSE/O 371 RSE 1997/99 ; OH 1625/OH 1636 1994/95

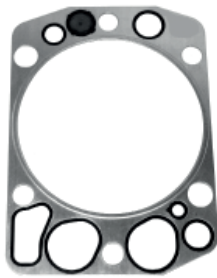

56137200

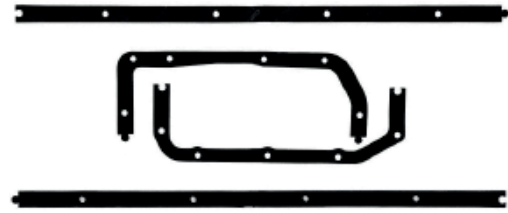

56151067

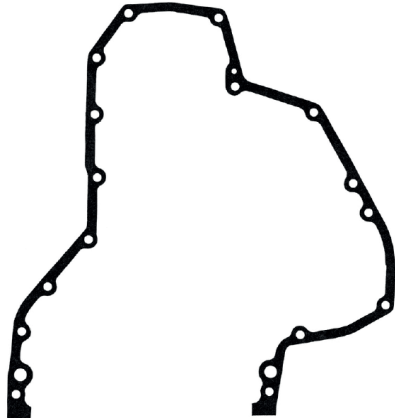

56142398



56151167



56132298

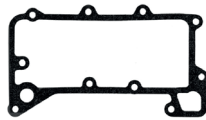

56132490



56129890



56130490



59651490



56130616



56139239



56130290



56141317



56132950



56132795



56128690



56132690



56142490



54308490



54308398



56128690



56141095



56145416



56132590



56164640



56130390



50014123

86149032 KIT LINER RING		
N° ABR	DESCRIPTION	QTD
56141119	CYLINDER LINER SHIM 147,3X153,3X0,15MM	1
56167840	RUBBER OIL SEAL 140,0 X 1,8 MM	1
56167940	RUBBER OIL SEAL 144,0 X 3,8 MM	2

60086116 KIT WASHERS		
N° ABR	DESCRIPTION	QTD
50023729	ALUMINUM WASHER 16,3 X 21,6 X 1,5MM	1
50021429	ALUMINUM WASHER 14,2X18,0X1,50MM	4
50032729	COPPER WASHER 18,3 X 22,2 X 1,50MM	1
50023624	COPPER WASHER 16,3 X 19,8 X 1,50MM	2
50072424	COPPER WASHER 22,5 X 26,7 X 1,50MM	1
50029520	COPPER WASHER 24,2 X 29,4 X 2,0MM	1
50030720	COPPER WASHER 26,3 X 30,9 X 2,00MM	1
50014123	COPPER WASHER 9,5 X 20,0 X 1,0MM	6

N° SET		DESCRIPTION							
66114611		FULL GASKET SET OM 457LA 6 CYLINDERS UP TO ENGINE 32558 WITHOUT LINER RINGS WITHOUT OIL SEAL							1
76114611		FULL GASKET SET OM 457LA 6 CYLINDERS UP TO ENGINE 32558 WITHOUT LINER RINGS WITH OIL SEAL							2
76114619		FULL GASKET SET OM 457LA 6 CYLINDERS UP TO ENGINE 32558 WITH LINER RINGS WITH OIL SEAL							3
66134611		MONOCYLINDER GASKET SET OM 457LA 6 CYLINDERS UP TO ENGINE 32558 WITHOUT LINER RINGS WITHOUT OIL SEAL							4
76134611		MONOCYLINDER GASKET SET OM 457LA 6 CYLINDERS UP TO ENGINE 32558 WITHOUT LINER RINGS WITH OIL SEAL							5
76134619		MONOCYLINDER GASKET SET OM 457LA 6 CYLINDERS UP TO ENGINE 32558 WITH LINER RINGS WITH OIL SEAL							6
N° ABR	N° ORIGINAL	DESCRIPTION							
56169405	4570161120	CYLINDER HEAD GASKET OM 457 6 CYLINDERS	1	1	1	6	6	6	
56164967	4570160021	VALVE COVER GASKET (ALUMINUM)	1	1	1	6	6	6	
56165940	A4570160221	VALVE COVER GASKET (PLASTIC)	1	1	1	6	6	6	
56165716	4571410080	INTAKE MANIFOLD GASKET (HTM-P)	1	1	1	6	6	6	
56169767		OIL PAN GASKET (OM457 6 CYLINDERS - SECTIONED)				1	1	1	
56151167	4070140222	OIL PAN GASKET (OM457 6 CYLINDERS - SECTIONED)				1	1	1	
56142377	4290150080	FRONT COVER GASKET				1	1	1	
56165167	4030110080	FRONT COVER GASKET				1	1	1	
RE02697F		ROCKER COVER BOLT SEALER				1	1		
RE02696F		FRONT CRAKSHAFT GASKET				1	1		
RE09237F		VALVE STEM SEAL	2	2		12	12		
50011024		COPPER WASHER 7,3 X 15,3 X 2,0 MM	1	1	1				
56130390	4422010480	WATER PUMP PIPE GASKET				1	1	1	
56132490	4031840280	OIL RADIADOR GASKET				1	1	1	
56132950	4750150180	OUTLET OIL GASKET				1	1	1	
56139239	4031420380	EXHAUST MANIFOLD GASKET	1	1	1	6	6	6	
56141119	4420110059	LINER SHIM 146,18 X 155,00 X 0,15MM	1	1	1	6	6	6	
56142490	917003026000	OIL COOLER GASKET				2	2	2	
56164590	A4572010080	WATER PUMP GASKET				1	1	1	
56165367	4602010080	FLANGE TO CYLINDER CRANKCASE GASKET				1	1	1	
56165431	4570910180	FUEL PUMP GASKET				1	1	1	
56165567	623208520044	INLET OIL GASKET				1	1	1	
56165667	4421870080	TURBOCHARING GASKET				1	1	1	
56166040		LINER RING 144.5 X 159.1 X 7,0 MM	2						
86151140		KIT RUBBER RINGS (WITH LINER RINGS)				1			
86151240		KIT RUBBER RINGS (WITHOUT LINER RINGS)					1	1	
86151329		KIT WASHER				1	1	1	

• SOLD SEPARATELY

APPLICATION

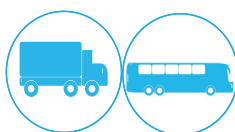

MERCEDES TRUCK AXOR 1938/2638 1998/06 ; 1944 2002/05

MERCEDES BUS O400 RSD 1998/04 ; O 400 RSE 1998/02

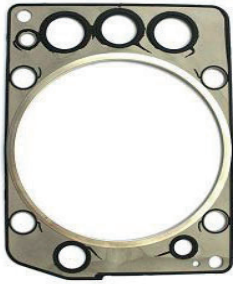

56169405

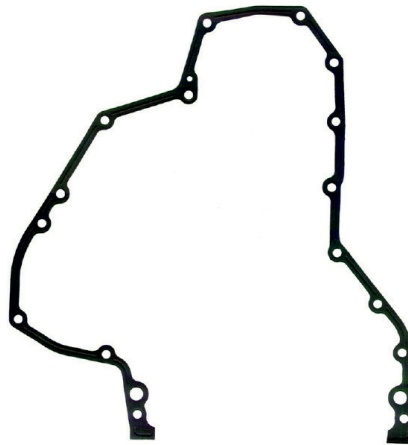

56142377



56164509



56151167

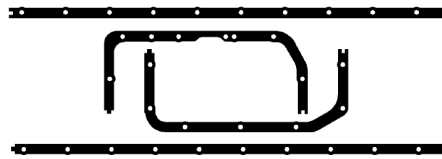

56169767

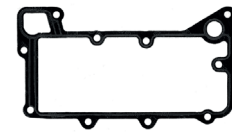

56132490



56165367



56165431



56139239



56165716



56130390



56142490



56165667



56165567



56164967



56165940



56166040



56141119



RE02696F



RE02697F



50011024



RE09237F



56165167

86151140		KIT RUBBER	
Nº ABR	DESCRIPTION	QTD	
56166040	LINER RING 144,5X159,1X7,0MM	12	
50037341	OIL SEAL 15,0 X 2,5MM	1	
50011741	OIL SEAL 57,0 X 3,5MM	1	
54388340	OIL SEAL 82,15 X 3,5MM	1	
	OIL SEAL 79,85 X 3,0MM	2	

86151240		RUBBER RINGS KIT WITHOUT LINER RINGS	
Nº ABR	DESCRIPTION	QTD	
50037341	OIL SEAL 15,0 X 2,5MM	1	
50011741	OIL SEAL 57,0 X 3,5MM	1	
54388340	OIL SEAL 82,15 X 3,5MM	1	
	OIL SEAL 79,85 X 3,0MM	2	

86151329		KIT WASHERS	
Nº ABR	DESCRIPTION	QTD	
50023624	COPPER WASHER 16,3 X 19,8 X 1,50MM	2	
50072424	COPPER WASHER 22,5 X 26,7 X 1,50MM	1	
50030420	COPPER WASHER 26,0 X 32,0 X 2,00MM	1	
	COPPER WASHER 26,3 X 31,7 X 3,00MM	1	
50022224	COPPER WASHER 14,6 X 20,8 X 1,50MM	3	
50022229	ALUMINUM WASHER 14,6 X 20,8 X 1,5MM	1	
50029720	COPPER WASHER 24,5 X 28,8 X 2,00MM	2	
50011023	COPPER WASHER 7,2 X 15,2 X 1,50MM	6	

Nº SET	DESCRIPTION	
66114631	FULL GASKET SET OM 457LA 6 CYLINDERS AFTER ENGINE 32559 WITHOUT LINER RINGS WITHOUT OIL SEAL	1
76114631	FULL GASKET SET OM 457LA 6 CYLINDERS AFTER ENGINE 32559 WITHOUT LINER RINGS WITH OIL SEAL	2
76114639	FULL GASKET SET OM 457LA 6 CYLINDERS AFTER ENGINE 32559 WITH LINER RINGS WITH OIL SEAL	3
76134599	MONOCYLINDER GASKET SET OM 457LA 6 CYLINDERS AFTER ENGINE 32559 WITH LINER RINGS WITH OIL SEAL	4
76134609	MONOCYLINDER GASKET SET OM 457LA 6 CYLINDERS AFTER ENGINE 32559 WITH LINER RINGS WITH OIL SEAL	

Nº ABR	Nº ORIGINAL	DESCRIPTION					
56165005	4570161220	CYLINDER HEAD GASKET OM 457 6 CYLINDERS	1	1	6	6	6
56164967	4570160021	VALVE COVER GASKET (ALUMINUM)	1	1	6	6	6
56165940	4570160221	VALVE COVER GASKET (PLASTIC)		1	6	6	6
56139239	4031420380	EXHAUST MANIFOLD GASKET	1		6	6	6
56168030	5411420380	EXHAUST MANIFOLD GASKET		1	6	6	6
56160530	4570980180	INTAKE MANIFOLD GASKET	1	1	6	6	6
56165716	4571410080	INTAKE MANIFOLD GASKET	1	1	6	6	6
56169767	4570140122	OIL PAN GASKET (OM457 6 CYLINDERS - SECTIONED)			1	1	1
56142377	4290150080	FRONT COVER GASKET			1	1	1
56165167	5410110080	FRONT COVER GASKET			1	1	1
56178767	4570110880	FRONT COVER GASKET			1	1	1
56179067	4600110180	FRONT COVER GASKET			1	1	1
RE05155T		ROCKER COVER BOLT SEALER			1	1	
RE05184T		FRONT CRACKSHAFT GASKET			1	1	
RE09237F		VALVE STEM SEAL	4	4	24	24	
50011024		COPPER WASHER 7,3 X 15,3 X 2,0 MM	1	1			
56130390	4222010480	WATER PUMP PIPE GASKET	1	1	1	1	1
56132490	4031840280	OIL RADIADOR GASKET			1	1	1
56132950	475.015.01.80	OUTLET OIL GASKET			1	1	1
56141119	4570110259	LINER SHIM 146,18 X 155,00 X 0,15MM	1	1	6	6	6
56142490	9170030260	OIL COOLER GASKET			1	1	1
56164590	4572010080	WATER PUMP GASKET			1	1	1
56165367	460.201.0080	FLANGE TO CYLINDER CRANKCASE GASKET			1	1	1
56165431	4570810180	FUEL PUMP GASKET					
56165567	6171870180	INLET OIL GASKET			1	1	1
56165667	4421870080	TURBOCHARING GASKET			1	1	1
56166040	4579970545	LINER RING 144,5 X 159,1 X 7,0 MM	2	2			
56174231	000160040	COVER VALVE GASKET			12	12	12
56178867	4570980880	INTAKE MANIFOLD GASKET			1	1	1
56180067	4571880280	OIL RADIADOR GASKET			1	1	1
56180850	A4570150080	INTAKE MANIFOLD GASKET 457 LA EURO 5			1	1	1
86151140		RUBBER RINGS KIT (WITH LINER RINGS)			1		
86151240		RUBBER RINGS KIT (WITHOUT LINER RINGS)				1	1
86153029		KIT WASHERS			1	1	1

●SOLD SEPARATELY

APPLICATION



MERCEDES TRUCK AXOR 1634/2640/4144 2006/12 ; 2035/2040/2044/2544/2644/3344 2005/12 ; 2535 2009/13 ; 2036 2011/... 2041/2541 2011/...2536 2012/... 2540 2004/12 ; 3340 2005/11 ; 4140 2005/11 ; 2641/3341/4141 2012/16 ; 2544/2644 2013/... 3344/4144 2013/...ATRON 1635 2012/...
 MERCEDES BUS O 500 MA/O 500 UA/O 500 RS/O 500 RSD 2006/12 ; O 500 RSDD/UDA/MDA 2013/...

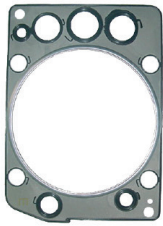

56165005

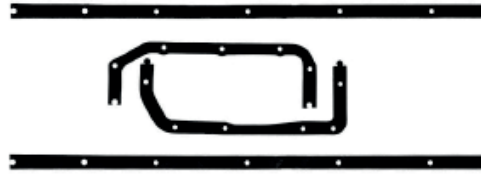

56169767

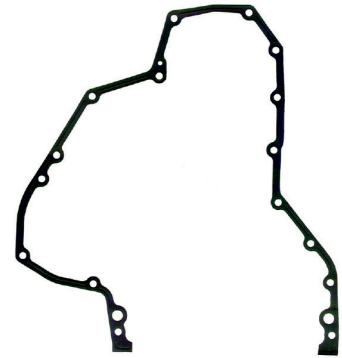

56142377



56164590



56139239



56165716



56168030



56165367



56132950



56130390



56165667



56142490



56165567



56160530



56180850



56165940



56164967



56178867

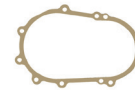

56178767



56166040

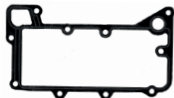

56132490

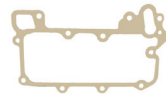

56180067



56165167



56179067



56141119



RE05184T



RE05155T



56174231



50011024



RE09237F

86151140		RUBBER KIT	
N° ABR	DESCRIPTION	QTD	
56166040	LINER RING 144,5X159,1X7,0MM	12	
50037341	OIL SEAL 15,0 X 2,5 MM	1	
50011741	OIL SEAL 57,0 X 3,5 MM	1	
54388340	OIL SEAL 82,15 X 3,5 MM	1	
	OIL SEAL 79,85 X 3,0 MM	2	

86151240		RUBBER RINGS KIT WITHOUT LINER RINGS	
N° ABR	DESCRIPTION	QTD	
50037341	OIL SEAL 15,0 X 2,5 MM	1	
50011741	OIL SEAL 57,0 X 3,5 MM	1	
54388340	OIL SEAL 82,15 X 3,5 MM	1	
	OIL SEAL 79,85 X 3,0 MM	2	

86153029		KIT WASHERS	
N° ABR	DESCRIPTION	QTD	
50023624	ALUMINUM WASHER 16,20 X 20,00 X 1,50MM	2	
50022224	ALUMINUM WASHER 14,30 X 18,30 X 1,50MM	21	
50072424	ALUMINUM WASHER 22,30 X 26,80 X 1,50MM	1	
	ALUMINUM WASHER 16,20 X 22,30 X 1,50MM	20	
	ALUMINUM WASHER 12,10 X 16,20 X 1,50MM	12	
	ALUMINUM WASHER 8,20 X 12,10 X 1,00MM	30	
50011024	COPPER WASHER 7,40 X 15,00 X 1,50MM	6	
	ALUMINUM WASHER 26,60 X 31,50 X 2,00MM	3	
	ALUMINUM WASHER 24,30 X 30,30 X 1,50MM	2	

MERCEDES OM 611 4 CYLINDERS 2.2L 16V ELETRONIC (EURO 3)

N° SET		DESCRIPTION		
76114651		FULL GASKET SET MERCEDES OM 611 SPRINTER 413 CDI 2.2 16V 98/ WITH OIL SEAL	1	
76134651		HEAD GASKET SET MERCEDES OM 611 SPRINTER 413 CDI 2.2 16V 98/ WITH OIL SEAL	2	
N° ABR	N° ORIGINAL	DESCRIPTION		
56175302 •	6110161120	CYLINDER HEAD GASKET	1	1
56175040 •	6110160121	VALVE COVER GASKET	1	1
56175231 •	6111420780	INTAKE MANIFOLD GASKET	1	1
56175131 •	6420140022	OIL PAN GASKET		1
56175440 •	6110980380	INTAKE MANIFOLD GASKET	4	4
RE07795T •	0219977647	FRONT OIL SEAL		1
RE05813S •	611010214	REAR OIL SEAL		1
RE07927F •		VALVE STEM SEAL	16	16
56174930	6112010280	WATER PUMP GASKET		1
56176540	6112030380	WATER PUMP GASKET	1	1
50011923		WASHER	4	
86152426		KIT WASHERS	1	1
86152526		KIT RUBBERS		1

• SOLD SEPARATELY

APPLICATION



MERCEDES VANS SPRINTER 311/313/413 CDI 2005/12 2005/12 ; 2535 2009/13 ; 2036 2011/...

MERCEDES OM 611 4 CILINDROS 2.2L 16V ELETTRONIC (EURO 3)



56175302

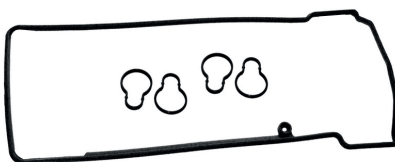

56175040

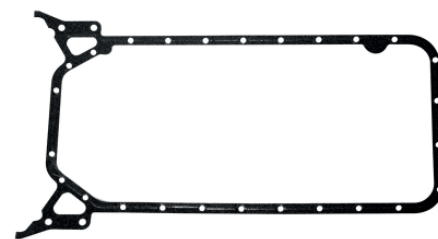

56175131



56175231

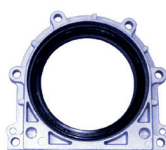

RE05813S



56176767



56176540



56175440



RE07795T



RE07927F

86151140		RUBBER KIT	
N° ABR	DESCRIPTION		QTD
56166040	LINER RING 144,5 X 159,1 X 7,0MM		12
50037341	OIL SEAL 15,0 X 2,5 MM		1
50011741	OIL SEAL 57,0 X 3,5 MM		1
54388340	OIL SEAL 82,15 X 3,5 MM		1
	OIL SEAL 79,85 X 3,0 MM		2

86152425		RUBBER KIT	
N° ORIGINAL	DESCRIPTION		QTD
0189971948	OIL SEAL 26,5 X 2,1MM		1
1110180080	OIL SEAL 47,5 X 59,0 X 2,3 MM		1
0069977548	OIL SEAL 36,5 X 2,0MM		1
0069977648	OIL SEAL 12,0 X 2,0MM		1
1049970048	OIL SEAL 10,0 X 2,0MM		1
0229978048	OIL SEAL 8,6 X 2,5MM		1
6112030380	WATER PUMP OIL SEAL		1
6111840280	OIL FILTER SEAL		1
6110980380	INTAKE MANIFOLD SEAL		4

N° SET		DESCRIPTION						
76119041		FULL GASKET SET OM 904 FOR PLASTIC VALVE COVER WITH OIL SEAL	1					
66119041		FULL GASKET SET OM 904 FOR PLASTIC VALVE COVER WITHOUT OIL SEAL	2					
76119241		FULL GASKET SET OM 924 FOR PLASTIC VALVE COVER WITH OIL SEAL	3					
66119241		FULL GASKET SET OM 924 FOR PLASTIC VALVE COVER WITHOUT OIL SEAL	4					
76139041	9040101921	HEAD GASKET SET OM 904 FOR PLASTIC VALVE COVER WITH OIL SEAL	5					
76139241	9240101520	HEAD GASKET SET OM 924 FOR PLASTIC VALVE COVER WITH OIL SEAL	6					
N° ABR	N° ORIGINAL	DESCRIPTION						
56182005	9040161320	CYLINDER HEAD GASKET OM 904 Ø103,7MM (NEW)	1				1	1
56182205	924 0161120	CYLINDER HEAD GASKET OM 924 Ø107,7 MM (NEW)	1	1	1			
56173340	0000160421	VALVE COVER GASKET (PLASTIC COVER)	1	1	1	1	1	1
56173540	9040160721	SIDE VALVE COVER GASKET	1	1	1	1	1	1
56175030	9061420280	EXHAUST MANIFOLD GASKET	2	2	2	2	2	2
56174431	9061410180	INTAKE MANIFOLD GASKET	2	2	2	2	2	2
56174667	9040140622	OIL PAN GASKET			1	1	1	1
RE05155T	0219975347	ROCKER COVER BOLT SEALER					1	1
RE05214T	0229977647	FRONT CRAKSHAFT GASKET					1	1
RE09284F	9060530358	VALVE STEM GASKET	12	12	12	12	12	12
56173831	9062030180	WATER CIRCULATION GASKETO	1	1	1	1	1	1
56174231	0000160040	SEAL RING	5	5	5	5	5	5
56174367	9062010080	WATER PUMP GASKET			1	1	1	1
56174867	9041880280	OIL COOLER COVER GASKET			1	1	1	1
56174931	9060910380	FUEL PUMP GASKET	1	1	1	1	1	1
56175840	0001883280	OIL COOLER GASKET	1	1	1	1	1	1
56179140	9041410280	INTAKE MANIFOLD GASKET	4	4	4	4	4	4
56184140		VALVE COVER GASKET						
86173340		KIT VALVE COVER GASKET (PLASTIC COVER) WITH OIL SEALES						
86151626		KIT WASHERS	1	1	1	1	1	1
86152046		RUBBER RINGS KIT	1	1	1	1	1	1

• SOLD SEPARATELY

APPLICATION

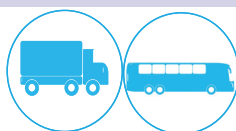

MERCEDES TRUCK OM924 (WITH PLASTIC VALVE COVER) 1622 2001/05 ; ACCELO 815/1016 2011/...ACCELO 1316 2015/...
ATEGO 1419 2012/...ATEGO 1719 2011/... / ATRON 1319 2012/16 ; ATRON 1719 2013/16
MERCEDES BUS OM924 (WITH PLASTIC VALVE COVER) OH 1521 1999/02 ; OH 1622L 2007/12 ; OF 1722 2001/11 ; OF 1722M 2003/12 ; OF 1721/OF 1721L 2004/...
OH 1621L 2013/...VOLARE BUS W9 FLY/DW9 FLY 2012/14
MERCEDES TRUCK OM904 (MERCEDES TRUCK OM904 WITH PLASTIC VALVE COVER) 1215C 1999/04 ; 914C 1999/03 ; 1718 2000/12 ; 1318 2003/12 ; 1218 2001/04 ; 1418 2001/03 ATEGO 1418 2004/12 ; ATEGO 1315 2005/10 ; ATEGO 1518/1718 2005/12 ; ACCELO 915C 2002/12
MERCEDES BUS OM904 (MERCEDES TRUCK OM904 WITH PLASTIC VALVE COVER) ATILIS 712E 2006/09 ;
LO 914 1999/04 ; LO 915 2003/12 ; OF 1218 2007/11 ; OF 1417 2001/06 ; OF 1418 2003/11 OH 1417 1998/05 ; OH 1418 2003/07 ; OH 1518 2006/12 ; OH 1519 2013/...

MERCEDES OM 904/924 4 CYLINDERS 4.25/4.8L ELETRONIC(EURO3/5)

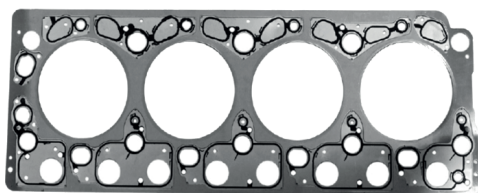

56182005 - THCKNESS 103,7 MM

56182205 - THCKNESS 107,7 MM

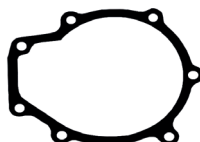

56174367

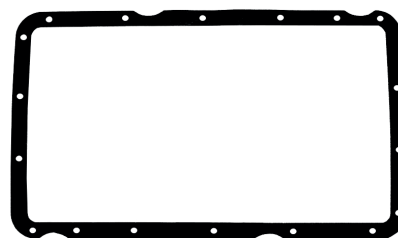

56174667

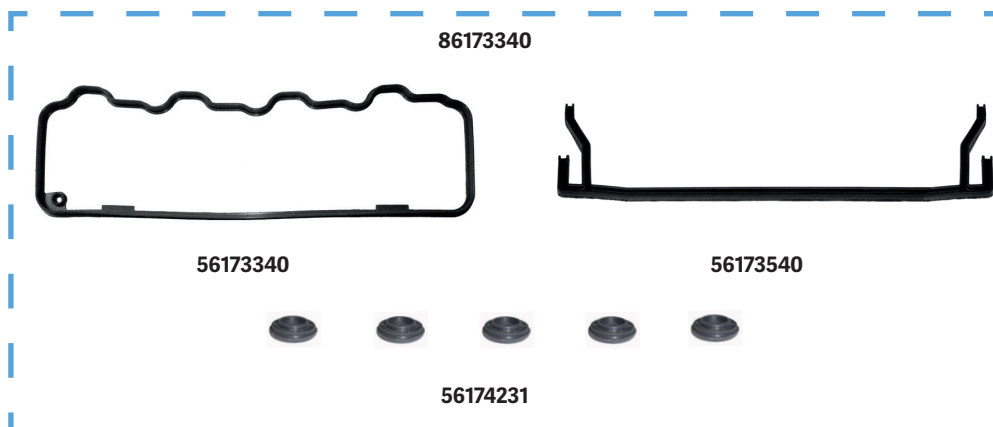

86173340

56173340

56173540

56174231

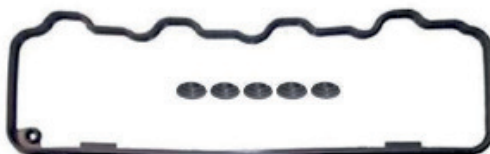

56184140



56175640



56174431



56175030



56175840



56174931



56173831



56179140



56174867



RE05155T



RE05214T



RE09284F

86151626 KIT WASHER		
N° ABR	DESCRIPTION	QTD
50030420	COPPER WASHER 26,0X32,0X2,0MM	1
50027329	COPPER WASHER 20,0X26,0X1,5MM	2
50069229	COPPER WASHER 18,0X22,0X1,5MM	1
50025424	COPPER WASHER 18,0X24,0X1,5MM	1
50021524	COPPER WASHER 14,3X19,8X1,5 MM	1
50021229	COPPER WASHER 14,0X20,0X1,5MM	1
50011023	COPPER WASHER 7,2X15,2X1,5 MM	4

86152046 KIT RUBBERS			
N° ABR	DESCRIPTION		QTD
0279978348	OIL SEAL 37,8X2,62MM		8
0239976848	OIL SEAL 9,0X2,5 MM		4
5419970745	OIL SEAL 25,0X3,7 MM		4
5419970545	OIL SEAL 20,9X3,0 MM		4
5419970645	OIL SEAL 11,0X3,0 MM		4
0209971148	OIL SEAL 60,0X4,2 MM		2
0249972148	OIL SEAL 118,0X3,0 MM		1
0020941580	OIL SEAL		1
9061840280	OIL SEAL		1

MERCEDES OM 906/926 6.4/7.2L ELETRONIC(EURO3/5)

Nº SET	DESCRIPTION
76119061	FULL GASKET SET OM 906 FOR PLASTIC VALVE COVER WITH OIL SEAL 1
66119061	FULL GASKET SET OM 906 FOR PLASTIC VALVE COVER WITHOUT OIL SEAL 2
76119261	FULL GASKET SET OM 926 FOR PLASTIC VALVE COVER WITH OIL SEAL 3
66119261	FULL GASKET SET OM 926 FOR PLASTIC VALVE COVER WITHOUT OIL SEAL 4
76139061	9040101921 HEAD GASKET SET OM 906 FOR PLASTIC VALVE COVER WITH OIL SEAL 5
76139261	9240101520 HEAD GASKET SET OM 926 FOR PLASTIC VALVE COVER WITH OIL SEAL 6

Nº ABR	Nº ORIGINAL	DESCRIPTION						
56182105	9060161420	CYLINDER HEAD GASKET OM 906 Ø103,7MM (NEW)		1				1 1
56182305	9260161220	CYLINDER HEAD GASKET OM 926 Ø107,7MM (NEW)	1		1	1		
56173440	0000160521	VALVE COVER GASKET (WITH PLASTIC COVER)	1	1	1	1	1	1
56184040		VALVE COVER GASKET (WITH PLASTIC COVER) WITH OIL SEAL						
56173640	9060160721	SIDE VALVE COVER GASKET	1	1	1	1	1	1
56175030	9061420280	EXHAUST MANIFOLD GASKET	3	3	3	3	3	3
56174431	9061410180	INTAKE MANIFOLD GASKET	3	3	3	3	3	3
56174767	9060140522	OIL PAN GASKET			1	1	1	1
RE05155T	219975347	ROCKER COVER BOLT SEALER					1	1
RE05214T	229977647	FRONT CRACKSHAFT GASKET					1	1
RE09284F	9060530358	VALVE STEM SEAL	18	18	18	18	18	18
56173831	9062030180	COOLER PIPE GASKET	1	1	1	1	1	1
56174231	0000160040	ISOLADOR DE RUIDO	7	7	7	7	7	7
56174367	9062010080	WATER PUMP GASKET			1	1	1	1
56174567	9061880280	OIL COOLER COVER GASKET			1	1	1	1
56174931	9060910380	FUEL PUMP GASKET	1	1	1	1	1	1
56175740	1883380	OIL COOLER GASKET	1	1	1	1	1	1
56179140	9041410280	INTAKE MANIFOLD GASKET	6	6	6	6	6	6
86173440		KIT VALVE COVER (WITH PLASTIC COVER)						
86151826		KIT WASHERS	1	1	1	1	1	1
86152146		RUBBER RINGS KIT	1	1	1	1	1	1

• SOLD SEPARATELY

APPLICATION

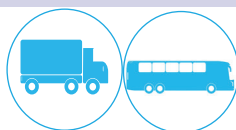

MERCEDES TRUCK OM926 (WITH PLASTIC VALVE COVER) 1728 2003/06 ; 2428 2001/06 ; ATEGO 1726/1729 2013/ ATEGO 1728/2428 2007/12 ; ATEGO 2426 2011/ ATEGO 2429 2012/15 ;
ATEGO 2430 2014/ATEGO 1730/2730/3026/3030 2016/ATRON 2324/2729 2011/16 ; AXOR 1933/2533 2005/AXOR 2831 2012/15 ; AXOR 3131 2013/
MERCEDES BUS OM926 (WITH PLASTIC VALVE COVER) O 500 M 2001/2011 ; O 500 R 2005/11 ; OF 1730 2010/12
MERCEDES TRUCK OM906 (WITH PLASTIC VALVE COVER) 2423 1999/09 ; 2726 2008/12 ; 1620 2006/12 ; ATEGO 1725 2009/12 ; ATEGO 2425 2005/12 ; AXOR 2826 2006/11 ;
MERCEDES BUS OM906 (WITH PLASTIC VALVE COVER) O 500 U 2013/...OH 1635 1995/99

MERCEDES OM 906/926 6.4/7.2L ELETRONIC(EURO3/5)

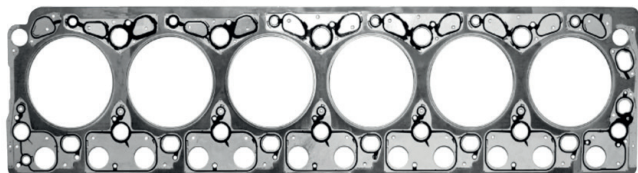

56182105 - THCKNESS 103,7 MM

56182305 - THCKNESS 107,7 MM

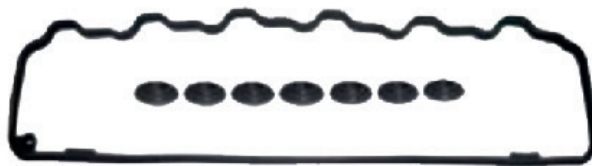

56184040

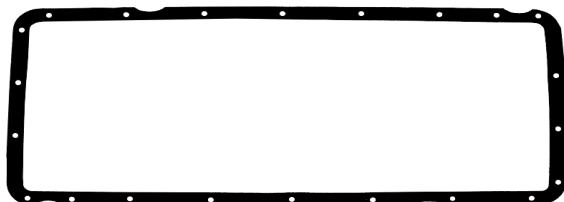

56174767

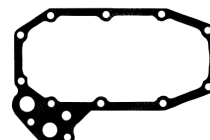

56174567

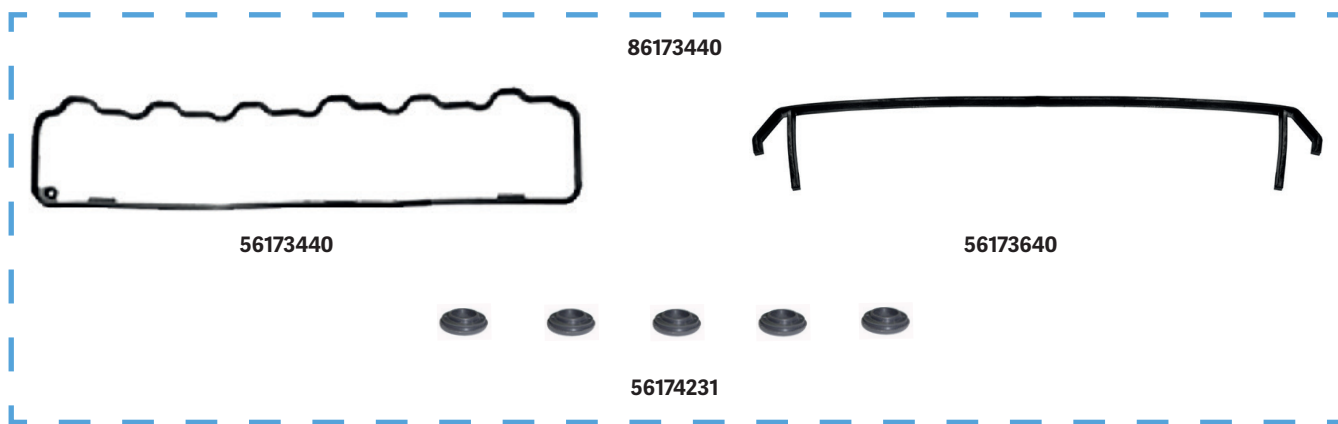

86173440

56173440

56173640

56174231

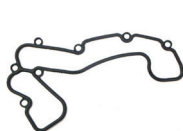

56175740



56175640



56174367



56174431



56175030



56174931



56173831



56179140



RE09284F



RE05214T



RE05155T



56174231

86151826		WASHER KIT	
N° ABR	DESCRIPTION	QTD	
50030420	COPPER WASHER 26,0X32,0X2,0MM	1	
50027329	COPPER WASHER 20,0X26,0X1,5MM	2	
50069229	ALUMINUM WASHER 18,0X22,0X1,5MM	1	
50021524	COPPER WASHER 14,3X19,8X1,5MM	1	
50023624	COPPER WASHER 16,3X19,8X1,5 MM	1	
50021229	ALUMINUM WASHER 14,0X20,0X1,5 MM	1	
50011023	COPPER WASHER 7,2X15,2X1,5 MM	6	

86152146		WASHER KIT	
N° ABR	DESCRIPTION	QTD	
0279978348	OIL SEAL 37,8X2,62MM	8	
0239976848	OIL SEAL 9,0X2,5MM	6	
5419970745	OIL SEAL 25,0X3,7MM	6	
5419970545	OIL SEAL 20,9X3,0MM	6	
5419970645	OIL SEAL 11,0X3,0MM	6	
0209971148	OIL SEAL 60,0X4,2MM	2	
0249972148	OIL SEAL 118,0X3,0MM	1	
0020941580	OIL SEAL	1	
9061840280	OIL FILTER SEAL	1	

MERCEDES OM 612 2.7L 20V ELETRONIC(EURO3)

N° SET		DESCRIPTION		
76114682		FULL GASKET SET MERCEDES OM 612 WITH OIL SEAL , INCLUDING REAR FLANGE	1	
76134682		HEAD GASKET SET MERCEDES OM 612 WITH OIL SEAL , INCLUDING REAR FLANGE	2	
N° ABR	N° ORIGINAL	DESCRIPTION		
56176002	6470161420	CYLINDER HEAD GASKET	1	1
56176140	6120160021	VALVE COVER GASKET	1	1
56176230	6121410180	INTAKE MANIFOLD GASKET	1	1
56176330	6121450380	INTAKE MANIFOLD GASKET	1	1
56176430	6120140122	OIL PAN GASKET		1
RE05813S	6110100214	REAR OIL SEAL		1
RE07795T	0219977647	FRONT OIL SEAL		1
RE07927F	0000534158	VALVE STEM GASKET	20	20
56176630		OIL COOLER GASKET		1
56176830		INLET OIL GASKET		1
56176540	6111840280	OIL FILTER GASKET		1
56176730	6112010280	WATER PUMP GASKET		1
86152640		KIT RUBBERS	1	1
56177040	6110940080	INTAKE MANIFOLD GASKET	5	5
56177140		OIL COOLER GASKET		1

•SOLD SEPARATELY

APPLICATION

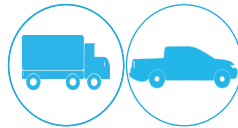

ENGINE MERCEDES OM 612 5 CYLINDERS 2.7L 20V ELETRONIC(EURO 3)

MERCEDES TRUCK ACCELO 715C DI 2002/11 ; JEEP GRAN CHEROKEE II 2001/05

MERCEDES OM 612 2.7L 20V ELETRONIC(EURO3)



5617002

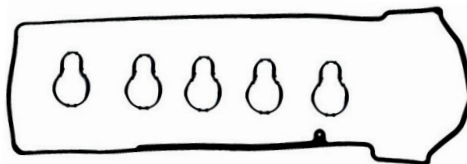

56176140

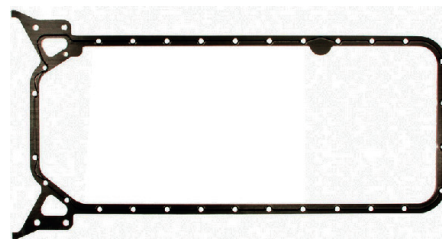

56176430

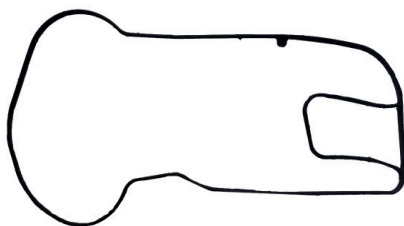

56177140

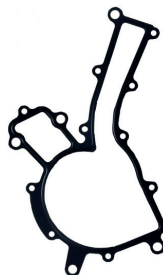

56176630



56176730



56176330



56176230



56176540



56176830



56177040



RE005813S



RE07795T



RE07927F



86152640

MERCEDES OM651 4 CYLINDERS 2.1L 16V CDI ELETRONIC(EURO5) 2012

N° SET		DESCRIPTION		
76112702		FULL GASKET SET MERCEDES OM651 CDI WITH OIL SEAL	1	
76132702		HEAD GASKET SET MERCEDES OM651 CDI WITH OIL SEAL	2	
N° ABR	N° ORIGINAL	DESCRIPTION		
56177302	6510160220	CYLINDER HEAD GASKET	1	1
56177240	6510160021	VALVE COVER GASKET UP TO 2011	1	1
56180940	6510160321	VALVE COVER GASKET 2012/...	1	1
56177432	6511420580	EXHAUST MANIFOLD GASKET	1	1
56177640	6510910060	INTAKE MANIFOLD GASKET	1	1
56177540	6510140080	OIL PAN GASKET		1
RE09116F	96*114*9	ROCKER COVER BOLT SEALER		1
RE09115F	69*75*7.5/8.5	FRONT CRAKSHAFT GASKET		1
RE09203F	5*8.5*9.5	VALVE STEM SEAL	16	16
56177730		EXHAUST PIPE GASKET	1	1
56177830	6510961180	REAR COVER GASKET	1	1
56177918	651422680	EGR VALVE GASKET	1	1
56178030	6510960480	TURBO GASKET	1	1
56178130	6511420380	EGR VALVE GASKET	1	1
56178230	6511420480	EGR VALVE GASKET	1	1
56178330	6511421280	EGR VALVE GASKET	1	1
56178430	6511421380	EGR VALVE GASKET	1	1
56178530	6511422380	EGR VALVE GASKET	1	1
56178630	6510960280	OIL RETURN GASKET	1	1
56181330	5612380180	OIL PUMP GASKET	1	1
56181430	5611422480	OIL COOLER GASKET	1	1
86152740		KIT RUBBERS		1
86152840		HEAD KIT RUBBER	1	

• SOLD SEPARATELY

APPLICATION



MERCEDES OM 651 A CYLINDERS 2.2L 16V ELETRONIC (EURO 5)

MERCEDES VANS SPRINTER 311/415/515 CDI 2012/...

MERCEDES OM651 4 CYLINDERS 2.1L 16V CDI ELETRONIC(EURO5) 2012

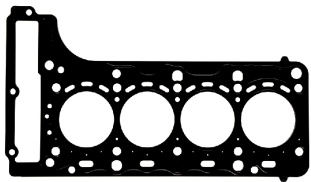

56177302

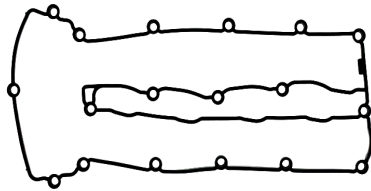

56177240

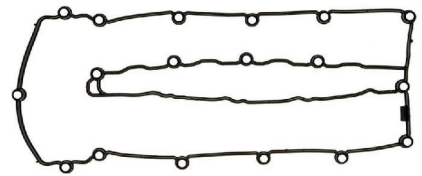

56180940

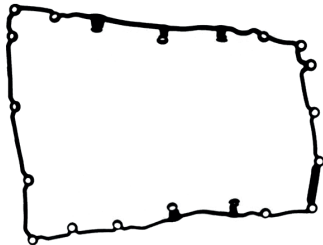

56177540



56177432



561781330



56177640



56181430



56177830



56178130



56178230



56177918



56178030



56178630



56178430



56178530



56178330



56177730



RE09116F



RE09115F



RE09203F

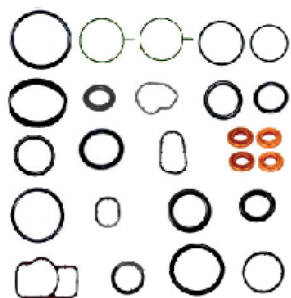

86152740

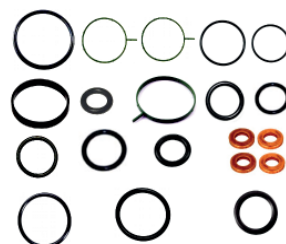

86152840

Nº SET	DESCRIPTION
76114735	FULL GASKET SET MERCEDES OM 501(012091 UP TO 084423)WITH OIL SEAL WITHOUT LINER RING 1
76114745	FULL GASKET SET MERCEDES OM 501(084424 UP TO 155295)WITH OIL SEAL WITHOUT LINER RING 2
76114715	FULL GASKET SET MERCEDES OM 501(155296 UP TO 377748)WITH OIL SEAL WITHOUT LINER RING 3
76114725	FULL GASKET SET MERCEDES OM 501(AFTER 377749)WITH OIL SEAL WITHOUT LINER RING 4
76134735	HEAD GASKET SET MERCEDES OM 501/502(ENGINE 012091 UP TO 084423)WITH OIL SEAL 5
76134745	HEAD GASKET SET MERCEDES OM 501/502(084424 UP TO 155295)WITH OIL SEAL 6
76134715	HEAD GASKET SET MERCEDES OM 501/502(155296 UP TO 377748)WITH OIL SEAL 7
76134725	HEAD GASKET SET MERCEDES OM 501/502(AFTER 377749)WITH OIL SEAL 8
76134730	BOTTOM GASKET SET MERCEDES OM 501(ALL)WITH OIL SEAL WITHOUT OIL PAN GASKET 9
76134720	BOTTOM GASKET SET MERCEDES OM 501(UP TO ENGINE 012090)WITH OIL SEAL WITH SOFT OIL PAN GASKET 10
76134710	BOTTOM GASKET SET MERCEDES OM 501(AFTER 012091)WITH OIL SEAL WITH RUBBER OIL PAN GASKET 11

Nº ABR	Nº ORIGINAL	DESCRIPTION											
56179205	5410161120	CYLINDER HEAD GASKET OM501/502 (UP TO 377748)			1	1	1		6	6	6		
56179305	5410161320	CYLINDER HEAD GASKET OM501/502 (AFTER 377749)			1				6				
56165940	4570160121	VALVE STEM SEAL OM501/502(AFTER 155296)OM 457			1	1			6	6			
56181040	5410160321	VALVE STEM SEAL OM501/502(UP TO 084423)					1				6		
56179440	5410160421	VALVE STEM SEAL OM501/502(084424 UP TO 155295)					1				6		
54168030	5411420280	EXHAUST MANIFOLD GASKET OM 501/502/457			1	1	1	1	6	6	6	6	
56179730	5410980480	INTAKE MANIFOLD GASKET OM 501/502			1	1	1	1	6	6	6	6	
56179540	5410140722	OIL PAN GASKET RUBBER OM502(AFTER ENGINE 012091)	1						1	1	1	1	
56179867	5410140322	OIL PAN GASKET SOFT OM502(UP TO ENGINE 012090)		1									
56180430	5410151180	FRONT COVER GASKET - LEFT	1	1	1				1	1	1	1	
56180530	5410151280	FRONT COVER GASKET - RIGHT	1	1	1				1	1	1	1	
56180340	5410151380	TIMING CASE COVER GASKET	1	1	1				1	1	1	1	
56180740	5410150160	TIMING CASE COVER GASKET	1	1	1				1	1	1	1	
RE02697T	139971447	ROCKER COVER BOLT SEALER MBB OM457/501/502	1	1	1				1	1	1	1	
RE02696T	149974647	FRONT CRAKSHAFT GASKET MBB OM457/501/502	1	1	1				1	1	1	1	
RE09237F	533558	VALVE STEM SEAL OM457/501/502				4	4	4	4	24	24	24	24
56132267	5410110080	REAR COVER GASKET	1	1	1				1	1	1	1	
56141030	5411310780	COMPRESSOR GASKET	2	2	2				2	2	2	2	
56169300	9425010080	INTAKE MANIFOLD GASKET	1	1	1				1	1	1	1	
56180130	5422010180	WATER PUMP GASKET	1	1	1				1	1	1	1	
56180230	5411840980	OIL COOLER GASKET	1	1	1				1	1	1	1	
56180630	5422010180	CONNECTION WATER PUMP GASKET	1	1	1				1	1	1	1	
56181132	5410110459	LINER SHIM 0,15MM	6	6	6				6	6	6	6	
86153140		KIT RUBBERS AND WASHERS	1	1	1				1	1	1	1	

• SOLD SEPARATELY

APPLICATION



MERCEDES TRUCK ACTROS 2646S 2010/... 2546S 2011/... 4844K 2008/17 4144K 2008/...

MERCEDES OM 501LA 6 CYLINDERS 12L V6 24V EURO 5

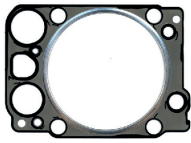

56179205

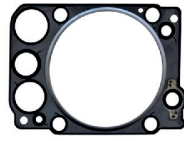

56179305



56179540

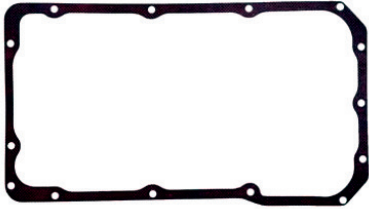

56179867

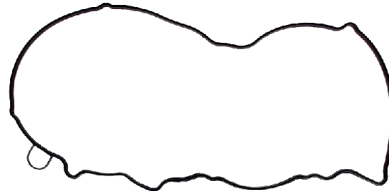

56180740



56180340

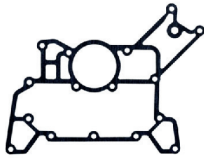

56180230

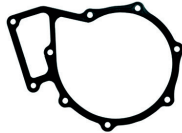

56177040



56180430



56180530



56132298



56181040



56179440



56165940



56141030



56179730



56180630



56169300



56168030



RE02697T



RE02696T



56181132



RE09237F



86153140

Nº SET	DESCRIPTION
76114755	FULL GASKET SET MERCEDES OM 502(012091 UP TO 084423)WITH OIL SEAL WITHOUT LINER RING 1
76114765	FULL GASKET SET MERCEDES OM 502(084424 UP TO 155295)WITH OIL SEAL WITHOUT LINER RING 2
76114775	FULL GASKET SET MERCEDES OM 502(155296 UP TO 377748)WITH OIL SEAL WITHOUT LINER RING 3
76114785	FULL GASKET SET MERCEDES OM 502(AFTER 377749)WITH OIL SEAL WITHOUT LINER RING 4
76134735	HEAD GASKET SET MERCEDES OM 501/502(012091 UP TO 084423)WITH OIL SEAL 5
76134745	HEAD GASKET SET MERCEDES OM 501/502(084424 UP TO 155295)WITH OIL SEAL 6
76134715	HEAD GASKET SET MERCEDES OM 501/502(155296 UP TO 377748)WITH OIL SEAL 7
76134725	HEAD GASKET SET MERCEDES OM 501/502(AFTER 377749)WITH OIL SEAL 8
76134760	BOTTOM GASKET SET MERCEDES OM 502(ALL)WITH OIL SEAL WITHOUT OIL PAN GASKET 9
76134750	BOTTOM GASKET SET MERCEDES OM 502(UP TO 012090)WITH OIL SEAL WITH SOFT OIL PAN GASKET 10
76134740	BOTTOM GASKET SET MERCEDES OM 502(AFTER012091)WITH OIL SEAL WITH RUBBER OIL PAN GASKET 11

Nº ABR	Nº ORIGINAL	DESCRIPTION										
56179205	5410161120	CYLINDER HEAD GASKET OM501/502 (UP TO ENGINE 377748)			1	1	1		8	8	8	
56179305	5410161320	CYLINDER HEAD GASKET OM501/502 (AFTER ENGINE 377749)			1				8			
56165940	4570160121	VALVE COVER GASKET OM501/502(AFTER 155296)OM 457			1	1			8	8		
56181040	5410160321	VALVE COVER GASKET OM501/502(UP TO 084423)					1				8	
56179440	5410160421	VALVE OVER GASKET OM501/502(084424 UP TO 155295)					1				8	
54168030	5411420280	EXHAUST MANIFOLD GASKET OM 501/502/457			1	1	1	1	8	8	8	8
56179730	5410980480	INTAKE MANIFOLD GASKET OM 501/502			1	1	1	1	8	8	8	8
56179967	5410140722	OIL PAN GASKET OM502(UP TO ENGINE 012090)SOFT					1					
56179640	5410140322	OIL PAN GASKET OM502(AFTER ENGINE 012091)RUBBER	1							1	1	1
56180430	5410151180	FRONT COVER GASKET - LEFT	1	1	1					1	1	1
56180530	5410151280	FRONT COVER GASKET - RIGHT	1	1	1					1	1	1
56180340	5410151380	TIMING CASE COVER GASKET	1	1	1					1	1	1
56180740	5410150160	TIMING CASE COVER GASKET	1	1	1					1	1	1
RE02697T	139971447	ROCKER COVER BOLT SEALERMBB OM457/501/502	1	1	1					1	1	1
RE02696T	149974647	FRONT CRAKSHAFT GASKET MBB OM457/501/502	1	1	1					1	1	1
RE09237F	533558	VALVE STEM SEAL OM457/501/502			4	4	4	4	32	32	32	32
56132267	5410110080	REAR COVER GASKET	1	1	1					1	1	1
56141030	5411310780	COMPRESSOR GASKET	2	2	2					2	2	2
56169300	9425010080	INLAKE WATER PUMP GASKET	1	1	1					1	1	1
56180130	5422010180	WATER PUMP GASKET	1	1	1					1	1	1
56180230	5411840980	OIL COOLER GASKET	1	1	1					1	1	1
56180630	5422010180	CONNECTION WATER PUMP GASKET	1	1	1					1	1	1
56181132	5410110459	LINER SHIM 0,15MM	8	8	8					8	8	8
86153140		KIT RUBBERS AND WASHERS	1	1	1					1	1	1

• SOLD SEPARATELY

APPLICATION



MERCEDES TRUCK ACTROS 2655 LS 2013/16

MERCEDES OM 502LA 8 CYLINDERS 16L 8/32V EURO 5

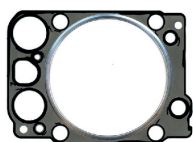

56179205

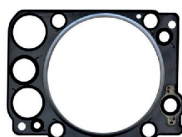

56179305



56179640

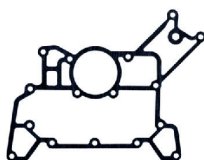

56180230

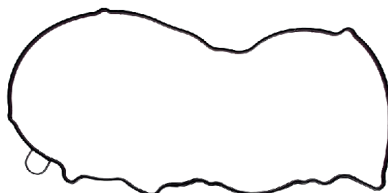

56180740



56180340



56132298

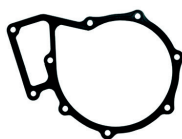

56180130



56180430



56180530



56141030



56181040



56179440



56165940



56181132



56179730



56180630



56169300



56168030



RE02697T



RE02696T



RE09237F



86153140



MWM

N° ABR	ENGINE	DESCRIPTION	PAGE
64311871	D226	FULL GASKET SET WITHOUT OIL SEAL	88
74311871	D226	FULL GASKET SET WITH OIL SEAL	88
64314181	D229	BOTTOM GASKET SET WITHOUT OIL SEAL	90
74314181	D229	BOTTOM GASKET SET WITH OIL SEAL	90
64414511	D229	FULL GASKET SET WITH OIL SEAL	90
74414511	D229	HEAD GASKET SET WITH OIL SEAL	90
64314193	D229	BOTTOM GASKET SET WITH OIL SEAL	94
74314193	D229	FULL GASKET SET WITHOUT OIL SEAL	94
64414543	D229	FULL GASKET SET WITH OIL SEAL	94
74414543	D229	HEAD GASKET SET WITHOUT OIL SEAL	94
78335941	6B/6BT	HEAD GASKET SET WITH OIL SEAL	98
68335940	6B/6BT	BOTTOM GASKET SET WITHOUT OIL SEAL	98
78335940	6B/6BT	BOTTOM GASKET SET WITH OIL SEAL	98
68310663	ISBe6 5.9L	FULL GASKET SET WITHOUT OIL SEAL	98
78310663	ISBe6 5.9L	FULL GASKET SET WITH OIL SEAL	102
68330661	ISBe6 5.9L	HEAD GASKET SET WITHOUT OIL SEAL	102
78330661	ISBe6 5.9L	HEAD GASKET SET WITH OIL SEAL	102
68330660	ISBe6 5.9L	BOTTOM GASKET SET WITHOUT OIL SEAL	102
78330660	ISBe6 5.9L	BOTTOM GASKET SET WITH OIL SEAL	104
68314943	6C/6CTA	FULL GASKET SET WITHOUT OIL SEAL	104
78314943	6C/6CTA	FULL GASKET SET WITH OIL SEAL	104
68334941	6C/6CTA	HEAD GASKET SET WITHOUT OIL SEAL	104
78334941	6C/6CTA	HEAD GASKET SET WITH OIL SEAL	104
68334940	6C/6CTA	BOTTOM GASKET SET WITHOUT OIL SEAL	104
78334940	6C/6CTA	BOTTOM GASKET SET WITH OIL SEAL	106
78314949	6C/6CTA	FULL GASKET SET WITH OIL SEAL WITH LINER RING	106
78334949	6C/6CTA	BOTTOM GASKET SET WITH OIL SEAL WITH LINER RING	106
68310593	ISC 8.3L/ ISL 8.9L	FULL GASKET SET WITHOUT OIL SEAL	108
78310593	ISC 8.3L/ ISL 8.9L	FULL GASKET SET WITH OIL SEAL	108
68330591	ISC 8.3L/ ISL 8.9L	HEAD GASKET SET WITHOUT OIL SEAL	108
78330591	ISC 8.3L/ ISL 8.9L	HEAD GASKET SET WITH OIL SEAL	112
68330590	ISC 8.3L/ ISL 8.9L	BOTTOM GASKET SET WITHOUT OIL SEAL	112
78330590	ISC 8.3L/ ISL 8.9L	BOTTOM GASKET SET WITH OIL SEAL	112
68310772	ISB4.5 / QSB4.5	FULL GASKET SET WITHOUT OIL SEAL	116
78310772	ISB4.5 / QSB4.5	FULL GASKET SET WITH OIL SEAL	116
68330771	ISB4.5 / QSB4.5	HEAD GASKET SET WITHOUT OIL SEAL	116
78330771	ISB4.5 / QSB4.5	HEAD GASKET SET WITH OIL SEAL	116
68330770	ISB4.5 / QSB4.5	BOTTOM GASKET SET WITHOUT OIL SEAL	116
78330770	ISB4.5 / QSB4.5	BOTTOM GASKET SET WITH OIL SEAL	116
68310752	ISB6.7/QSB6.7	FULL GASKET SET WITHOUT OIL SEAL	116

MWM D226 4 CYLINDERS 4.2 LITER

N° SET		DESCRIPTION		
64311871		FULL GASKET SET MWM D226 WITHOUT OIL SEAL	1	
74311871		FULL GASKET SET MWM D226 WITH OIL SEAL	2	
N° ABR	N° ORIGINAL	DESCRIPTION		
54307800 •	622608540034	CYLINDER HEAD GASKET Ø106,5MM	4	4
54307652 •	920808530014	VALVE COVER GASKET	4	4
54307316 •	620708530074	EXHAUST MANIFOLD GASKET	4	4
54310816 •	632138530094	INTAKE MANIFOLD GASKET	4	4
54310590	630508530144	OIL PAN GASKET 4 CYLINDERS (SECTIONED)	1	1
54311398 •	632508530184	FRONT COVER GASKET	1	1
RE00803S •	922988560044	REAR OIL SEAL 110X130X13MM	1	
RE01917S •	922988560034	FRONT OIL SEAL 78X100X13MM	1	
54307190	620508530124	INJECTION PUMP GASKET	1	1
54307290	620608530014	WATER PUMP GASKET	1	1
54310790	030508530214	OIL FILTER GASKET	1	1
54310990	632148530124	INJECTION PUMP GASKET	1	1
54311190	632508530054	REAR COVER GASKET	1	1
54311290	632508530154	INSPECTION COVER GASKET	1	1
54312216	922508510014	EXHAUST CURVE GASKET	1	1
54314090	922608530124	INJECTION PUMP GASKET	1	1
54314190	922608530134	FUEL PUMP GASKET	2	2
54314290	922608530104	AIR FILTER GASKET	1	1
54315090	922208530134	WATER PUMP GASKET	1	1
60011870		KIT WASHERS	1	1
84383941		KIT RUBBERS	1	1
U4301567	922508530024	OIL PAN GASKET - COMPLEMENT	2	2

• SOLD SEPARATELY

APPLICATION

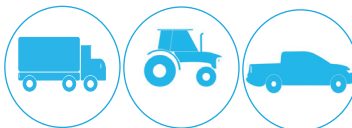

FORD PICK-UP F4000 1975/82 ; F1000 1977/79 ;

VOLKSWAGEN 6.90 1982/86 ;

MASSEY FERGUSON MF85X 1975/78 / VALTRA TRACTOR 86ID 1981/88 ; CASE TRACTOR CA-875/CA-1140 1979/... ; VALTRA 86 ID 1981/88

MWM D226 4 CYLINDERS 4.2 LITER



54307800-THCKNESS 106,5 MM

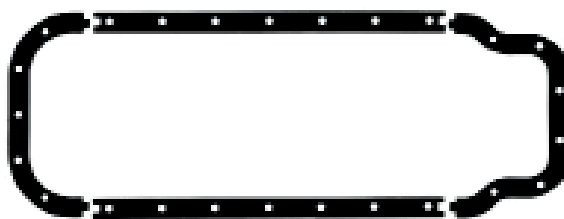

54310590



U4301567

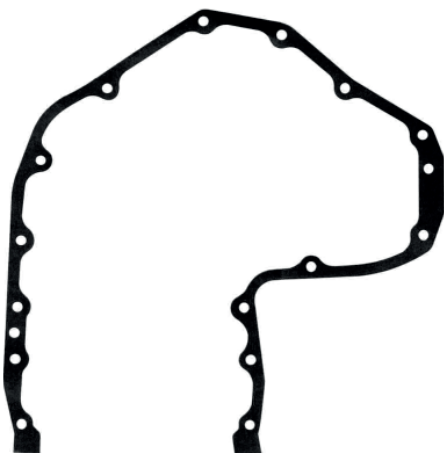

54311398

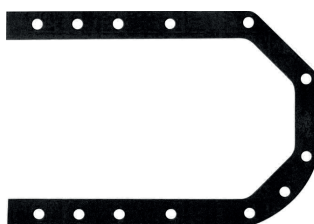

54311190



54307652

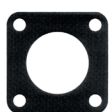

54312216



54314290



54307190



54311290



54315090



54307290



54310790



54307316



54310816



54314090



54314190



54310990



RE00803S



RE01917S

84383941		KIT RUBBERS	
N° ABR	DESCRIPTION		QTD
50004741	SEALER 44,0X3,0 MM		1
50005441	SEALER 32,0X4,0 MM		2
50055741	SEALER 22,0X32,5X7,8 MM		4
50005741	SEALER 20,0X4,0 MM		1

60011870		KIT WASHERS	
N° ABR	DESCRIPTION		QTD
50021429	ALUMINIUM WASHER 14,2X18,0X1,5 MM		11
50012128	ALUMINIUM WASHER 10,5X15,8X1,0 MM		14
50012128	ALUMINIUM WASHER 8,3X13,0X1,0 MM		2
	ALUMINIUM WASHER 8,3X11,8X1,0 MM		3
50072428	ALUMINIUM WASHER 22,5X26,7X1,0 MM		1
50015728	ALUMINIUM WASHER 10,2X13,9X1,0 MM		4
50014130	ALUMINIUM WASHER 9,5X20,0X2,0 MM		4

MWM D229 4 CYLINDERS 3.9LITER

N° SET		DESCRIPTION				
64314181	FULL GASKET SET D229 4 CYLINDERS FORD F1000/2000/4000,VOLKSWAGEN6.90/7.90 ASPIRATED WITHOUT OIL SEAL		1			
74314181	FULL GASKET SET D229 4 CYLINDERS FORD F1000/2000/4000,VOLKSWAGEN6.90/7.90 ASPIRATED WITH OIL SEAL		2			
64414511	FULL GASKET SET D229 4 CYLINDERS AGRALE 5075/85,VALMET 78/88/785/880 ASPIRATED WITHOUT OIL SEAL		3			
74414511	FULL GASKET SET D229 4 CYLINDERS AGRALE 5075/85,VALMET 78/88/785/880 ASPIRATED WITH OIL SEAL		4			
N° ABR	N° ORIGINAL	DESCRIPTION				
54305990	922988531354	OIL COOLER GASKET	1	1	1	1
54306545	604931301124	LINER RING	8	8	8	8
54307190	922988531684	INJECTION PUMP GASKET	1	1	1	1
54307316	922908531174	EXHAUST MANIFOLD GASKET	8	8	8	8
54308395	961005258014	OIL RETURN GASKET				
54308490	961008528024	INLET OIL GASKET				
54310590	922988531484	OIL PAN GASKET	1	1	1	1
54310790	922988531624	LUBRIFICANT FILTER GASKET	1	1	1	1
54310990	922988531674	FUEL PUMP GASKET	1	1	1	1
54311090	922988531094	OIL FILTER GASKET	1	1	1	1
54311190	922988531424	REAR COVER GASKET	1	1	1	1
54311290	922988531444	INSPECTION COVER GASKET	1	1	1	1
54311398	932508530184	FRONT COVER GASKET	1	1	1	1
54311867		COMPLEMENT GASKET	2	2		
54312216	922508510014	EXHAUST CURVE GASKET	1	1	1	1
54312790	922988531574	PUMP COVER GASKET	1	1	1	1
54314290	922608530104	AIR FILTER GASKET	1	1	1	1
54315090	922988531464	WATER PUMP GASKET	1	1	1	1
54319000	922908541044	CYLINDER HEAD GASKET	4	4	4	4
54320217	922908531204	EXHAUST GASKET			1	1
54324144	922908530444	VALVE COVER GASKET			4	4
54324156	922908530064	VALVE COVER GASKET	4	4		
54328916	922908531274	EXHAUST MANIFOLD GASKET	1	1		
54330590	922988531474	WATER PUMP GASKET	1	1	1	1
54333517	922908531324	TURBOCHARGING GASKET				
54338917	922908530684	EXHAUST MANIFOLD GASKET				
54340090	922988531414	RADIATOR COVER GASKET	1	1	1	1
54340290	922988531644	OIL BREATHER GASKET	1	1	1	1
54413147	922908531334	EXHAUST MANIFOLD GASKET	1	1		
56121131	3520980880	TURBOCHARGING GASKET				
56121231	3520980280	TURBOCHARGING GASKET				
60014140		REAR OIL SEAL	1	1	1	1
84384146		FRONT OIL SEAL	1	1	1	1
84395246		KIT WASHERS				
RE00803S		KIT RUBBERS			1	
RE01917S		KIT RUBBERS				

● SOLD SEPARATELY



APPLICATION

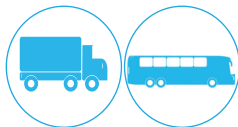

MWM D229/4 CYLINDERS 3.9L, MWM TD229/4 CYLINDERS 3.9L TURBO,

VOLKSWAGEN TRUCK 13110/13130 1981/87 ; FORD BUS B12000 1993/96

FORD TRUCK 1113/1114/1313/1314 1985/89 ; F11000/12000/14000/22000 1981/92 ; F13000/21000 1981/89 ; F19000 1981/82

VOLKSWAGEN TRUCK 11140 1987/93 ; 12140 1987/96 ; 14140 1987/91 ; 22140 1987/90

AGRALE TRACTOR BX6150/BX6180 2004/...BX4130 1990/...7215 2016/...6185 2018/...

VALTRA TRACTOR 1280 1991/11 1380 1991/93 1580 1986/91 118/118-4 1981/86 128 1986/02

FIAT TRACTOR 7D 1984/...CASE TRACTOR CA-1170/CA-1175 1979/...

VALTRA TRACTOR 138 1983/89 ; 138-4 1984/89 ; 148 1986/89 ; 1580 1992/08 ; 1680 1990/96 ; 1780 1991/09 ;

1880 1988/96 ; FIAT TRACTOR FD9 1984/...FD130

MWM D229 4 CYLINDERS 3.9LITER

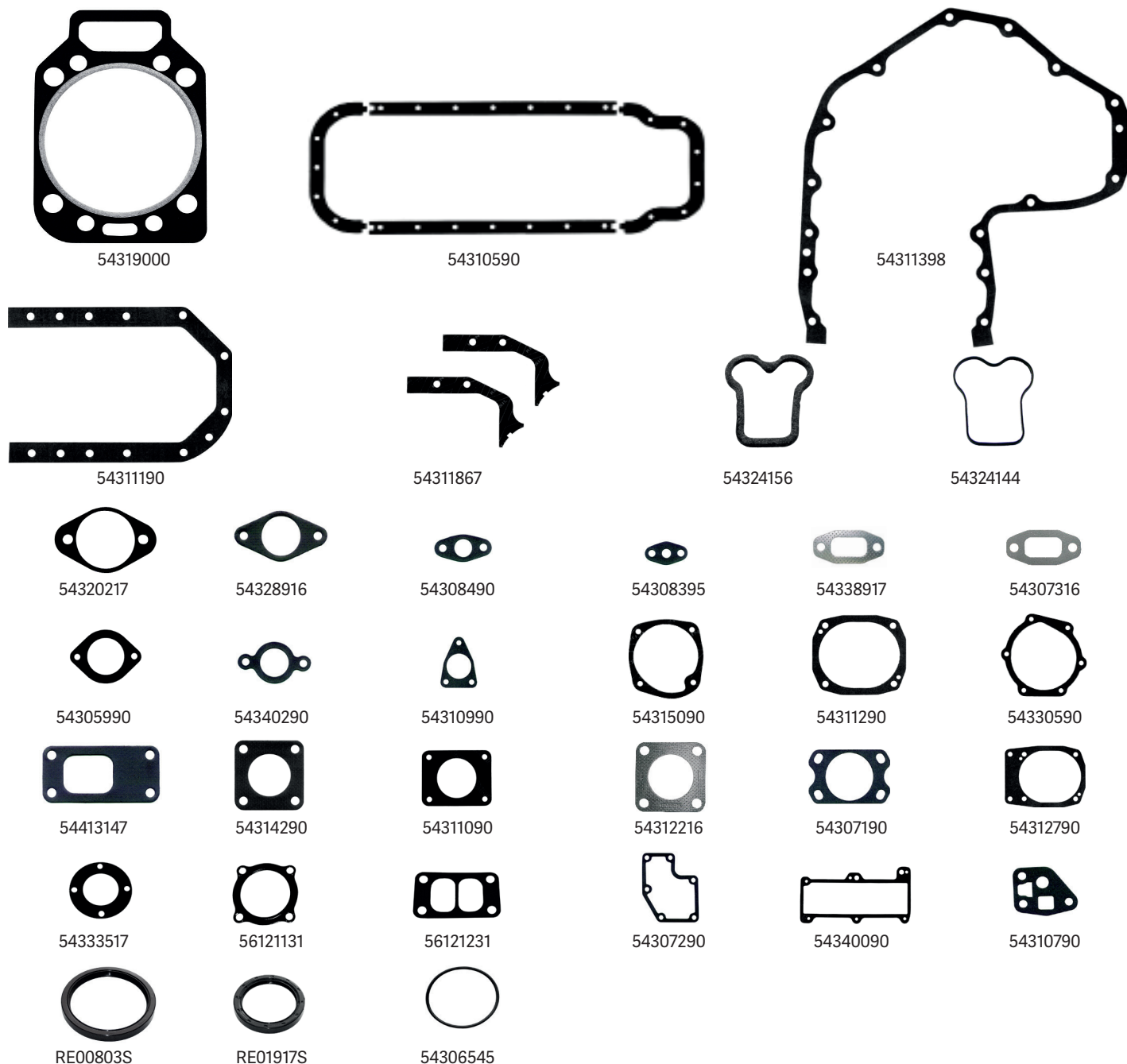

84384146 KIT RUBBER D229 4 CYLINDERS			
N° ABR	DESCRIPTION	QTD	
50006241	SEALER 40,0X3,0 MM	2	
50005441	SEALER 32,0X4,0 MM	1	
50005941	SEALER 6,0X2,0 MM	1	
50010141	SEALER 20,0X2,0 MM	4	
50005541	SEALER 34,0X4,0 MM	1	
50004741	SEALER 44,0X3,0 MM	1	
50009941	SEALER 46,0X3,0 MM	1	

60014140 KIT WASHERS D229/TD229 4 CYLINDERS			
N° ABR	DESCRIPTION	QTD	
50011428	ALUMINUM WASHER 8,3X13,8X1,0 MM	4	
50011428	STEEL WASHER 9,5X20,0X2,0 MM	4	
50011428	ALUMINUM WASHER 8,0X12,0X1,0 MM	14	
50011428	ALUMINUM WASHER 10,0X16,0X1,0 MM	4	
50011428	ALUMINUM WASHER 10,0X13,8X1,0 MM	1	
50011428	ALUMINUM WASHER 14,0X18,0X1,5 MM	12	
50011428	ALUMINUM WASHER 22,0X27,0X10 MM	2	

84395246 KIT RUBBER D229 4 CYLINDERS TURBO			
N° ABR	DESCRIPTION	QTD	
50026941	SEALER 75,0X3,0 MM	1	
50005741	SEALER 20,0X4,0 MM	1	
50005941	SEALER 6,0X2,0 MM	2	
50010141	SEALER 20,0X2,0 MM	4	
50005541	SEALER 34,0X4,0 MM	1	
50004741	SEALER 44,0X3,0 MM	1	
54384640	SEALER 42,0X3,0 MM	2	
54386740	SEALER 12,5X2,6 MM	1	
50037141	SEALER 14,0X3,0 MM	4	
54385640	SEALER 40,0X5,0 MM	2	
54387840	SEALER 25,0X4,0 MM	1	

MWM TD229 4 CYLINDERS 3.9LITER

N° SET		DESCRIPTION				
64314193		FULL GASKET SET TD229 4 CYLINDERS FORD F1000/4000, VOLKSWAGEN 7110 TURBO WITHOUT OIL SEAL	1			
74314193		FULL GASKET SET TD229 4 CYLINDERS FORD F1000/4000, VOLKSWAGEN 7110 TURBO WITH OIL SEAL	2			
64414543		FULL GASKET SET TD229 4 CYLINDERS VALMET 980 TURBO WITHOUT OIL SEAL	3			
74414543		FULL GASKET SET TD229 4 CYLINDERS VALMET 980 TURBO WITH OIL SEAL	4			
N° ABR	N° ORIGINAL	DESCRIPTION				
54305990	922988531354	OIL COOLER GASKET	1	1	1	1
54306545	604931301124	SEALER DA CAMISA	8	8	8	8
54307190	922988531684	INJECTION PUMP GASKET	1	1	1	1
54307316	922908531174	EXHAUST MANIFOLD GASKET	4	4	4	4
54308395	961005258014	OIL RETURN GASKET	1	1	1	1
54308490	961008528024	INLET OIL GASKET	1	1	1	1
54310590	922988531484	OIL PAN GASKET	1	1	1	1
54310790	922988531624	LUBRIFICANT FILTER GASKET	1	1	1	1
54310990	922988531674	FUEL PUMP GASKET	1	1	1	1
54311090	922988531094	OIL FILTER GASKET	1	1	1	1
54311190	922988531424	REAR COVER GASKET	1	1	1	1
54311290	922988531444	INSPECTION COVER GASKET	1	1	1	1
54311398	932508530184	FRONT COVER GASKET	1	1	1	1
54311867		COMPLEMENT GASKET	2	2		
54312216	922508510014	EXHAUST CURVE GASKET	1	1	1	1
54312790	922988531574	PUMP COVER GASKET	1	1	1	1
54314290	922608530104	AIR FILTER GASKET	1	1	1	1
54315090	922988531464	WATER PUMP GASKET	1	1	1	1
54319000	922908541044	CYLINDER HEAD GASKET	4	4	4	4
54320217	922908531204	EXHAUST GASKET			1	1
54324144	922908530444	VALVE COVER GASKET	4	4	4	4
54324156	922908530064	VALVE COVER GASKET			4	4
54328916	922908531274	EXHAUST MANIFOLD GASKET	1	1		
54330590	922988531474	WATER PUMP GASKET	1	1	1	1
54333517	922908531324	TURBOCHARGING GASKET	1	1		
54338917	922908530684	EXHAUST MANIFOLD GASKET	4	4	4	4
54340090	922988531414	RADIATOR COVER GASKET	1	1	1	1
54340290	922988531644	OIL BREATHER GASKET	1	1	1	1
54413147	922908531334	EXHAUST MANIFOLD GASKET	1	1		
56121131	3520980880	TURBOCHARGING GASKET			1	1
56121231	3520980280	TURBOCHARGING GASKET	1	1	1	1
60014140		REAR OIL SEAL	1	1	1	1
84384146		FRONT OIL SEAL				
84395246		KIT WASHERS	1	1	1	1
RE00803S		KIT RUBBERS		1		1
RE01917S		KIT RUBBERS	1			

● SOLD SEPARATELY



APPLICATION

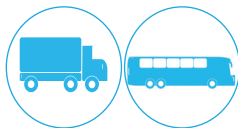

MWM D229/4 CYLINDERS 3.9L, MWM TD229/4 CYLINDERS 3.9L TURBO,

VOLKSWAGEN TRUCK 13110/13130 1981/87 ; FORD BUS B12000 1993/96

FORD TRUCK 1113/1114/1313/1314 1985/89 ; F11000/12000/14000/22000 1981/92 ; F13000/21000 1981/89 ; F19000 1981/82

VOLKSWAGEN TRUCK 11140 1987/93 ; 12140 1987/96 ; 14140 1987/91 ; 22140 1987/90

AGRALE TRACTOR BX6150/BX6180 2004/...BX4130 1990/...7215 2016/...6185 2018/...

VALTRA TRACTOR 1280 1991/11 1380 1991/93 1580 1986/91 118/118-4 1981/86 128 1986/02

FIAT TRACTOR 7D 1984/...CASE TRACTOR CA-1170/CA-1175 1979/...

VALTRA TRACTOR 138 1983/89 ; 138-4 1984/89 ; 148 1986/89 ; 1580 1992/08 ; 1680 1990/96 ; 1780 1991/09 ;

1880 1988/96 ; FIAT TRACTOR FD9 1984/...FD130

MWM TD229 4 CYLINDERS 3.9LITER

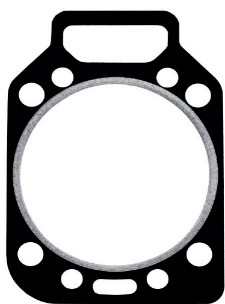

54319000



54310590



54311398

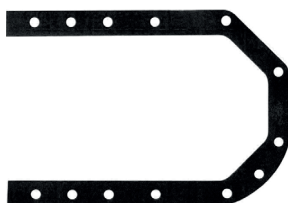

54311190



54311867



54324156



54324144



54320217



54328916



54308490



54308395



54338917



54307316



54305990



54340290



54310990



54315090

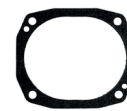

54311290



54330590



54413147



54314290



54311090



54312216



54307190



54312790



54333517



56121131



56121231



54307290

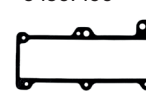

54340090



54310790



RE00803S



RE01917S



54306545

84384146 KIT RUBBER D229 4 CYLINDERS		
N° ABR	DESCRIPTION	QTD
50006241	SEALER 40,0X3,0 MM	2
50005441	SEALER 32,0X4,0 MM	1
50005941	SEALER 6,0X2,0 MM	1
50010141	SEALER 20,0X2,0 MM	4
50005541	SEALER 34,0X4,0 MM	1
50004741	SEALER 44,0X3,0 MM	1
50009941	SEALER 46,0X3,0 MM	1

84395246 KIT RUBBER D229 4 CYLINDERS TURBO		
N° ABR	DESCRIPTION	QTD
50026941	SEALER 75,0X3,0 MM	1
50005741	SEALER 20,0X4,0 MM	1
50005941	SEALER 6,0X2,0 MM	2
50010141	SEALER 20,0X2,0 MM	4
50005541	SEALER 34,0X4,0 MM	1
50004741	SEALER 44,0X3,0 MM	1
54384640	SEALER 42,0X3,0 MM	2
54386740	SEALER 12,5X2,6 MM	1
50037141	SEALER 14,0X3,0 MM	4
54385640	SEALER 40,0X5,0 MM	2
54387840	SEALER 25,0X4,0 MM	1

60014140 KIT WASHERS D229/TD229 4 CYLINDERS		
N° ABR	DESCRIPTION	QTD
50011428	ALUMINIUM WASHER 8,3X13,8X1,0 MM	4
50011428	STEEL WASHER 9,5X20,0X2,0 MM	4
50011428	ALUMINIUM WASHER 8,0X12,0X1,0 MM	14
50011428	ALUMINIUM WASHER 10,0X16,0X1,0 MM	4
50011428	ALUMINIUM WASHER 10,0X13,8X1,0 MM	1
50011428	ALUMINIUM WASHER 14,0X18,0X1,5 MM	12
50011428	ALUMINIUM WASHER 22,0X27,0X10 MM	2

MWM 4.10(X10/4CYLINDERS) ASPIRAD AND TURBO 4.3LITER 8VÁLVULAS(EURO 2)

Nº SET	DESCRIPTION	
64315061	FULL GASKET SET X10 4 CYLINDERS WITHOUT OIL SEAL	1
74315061	FULL GASKET SET X10 4 CYLINDERS WITH OIL SEAL	2
64315071	FULL GASKET SET X10 4 CYLINDERS WITHOUT OIL SEAL	3
74315071	FULL GASKET SET X10 4 CYLINDERS WITH OIL SEAL	4

Nº ABR	Nº ORIGINAL	DESCRIPTION				
RE02927F		VALVE STEM SEAL	12	12	8	8
54308395	961008528014	OIL RETURNE GASKET	1	1	1	1
54308490	961008528024	INLET OIL GASKET	1	1	1	1
54325016	922908530144	EXHAUST CURVE GASKET	1	1	1	1
54325117	922908530754	MEETING TURBOCHARGER	1	1	1	1
54349790	961088530374	TIMING COVER GASKET	1	1		
54349890	941088530334	OIL RADIATOR GASKET	2	2	2	2
54350590	941088530354	INLET WATER NOZZLE GASKET	1	1	1	1
54350690	961088530394	ALTERNATOR GASKET	1	1	1	1
54350790	961088530404	TIMING COVER GASKET	1	1		
54350990	961088530394	OIL COOLER GASKET	1	1	1	1
54351090	961088530344	TERMOSTAT GASKET	1	1	1	1
54351417	961008530204	EXHAUST MANIFOLD GASKET	6	6	4	4
54352090	961088530354	OIL PAN GASKET	1	1		
54353108	961008530194	COLLECTOR EXHAUST CURVE GASKET	1	1		
54353216	961008530144	INTAKE MANIFOLD GASKET	6	6	4	4
54353816	961088530364	EXHAUST MANIFOLD GASKET	1	1	1	1
54355432	961008530214	TURBOCHARGING GASKET	1	1	1	1
54355544	961008530124	FRONT COVER GASKET	4	4	3	3
54355990	941088530304	FUEL LIFT PUMP GASKET	1	1	1	1
54360216	941088530414	INTAKE MANIFOLD GASKET	1	1	1	1
54360395	941088530314	INJECTION PUMP GASKET	1	1	1	1
54360516	941008530034	OUTLET EXHAUST CURVE GASKET			1	1
54360990	941088530374	OIL PAN GASKET			1	1
54362590	941088530424	REAR TIMING COVER GASKET	1	1	1	1
54362690	941088530384	FRONT TIMING COVER GASKET	1	1	1	1
54364904	961008540144	CYLINDER HEAD GASKET	6	6	4	4
54367716	961088530384	INTAKE MANIFOLD GASKET	1	1		
54368316	941088530346	INTAKE MANIFOLD CURVE GASKET			1	1
54369590	941088530244	INTERMEDIATE DISTRIBUTION GASKET	1	1	1	1
54376845	904931361131	LINER SHIM	12	12	8	8
54353444	961008530034	VALVE COVER GASKETS	6	6	4	4
84384826		KIT WASHER	1	1	1	1
84384926		KIT WASHER	1	1	1	1
84385046		KIT RUBBERS	1	1	1	1
84385126		KIT RUBBERS	1	1	1	1
RE02871S		FRONT OIL SEAL	1		1	
RE02872S		REAR OIL SEAL	1		1	

● SOLD SEPARATELY

MWM 4.10(X10/4CYLINDERS) ASPIRAD AND TURBO 4.3LITER 8VALVES(EURO 2)

APPLICATION

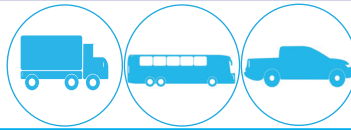

MWM 4.10(X10/4 CYL) ASPIRATED E TURBO 4.3L 8V(EURO 2)

VOLKSWAGEN TRUCK 7100/8140 1994/00 ; 8100 1997/00 ; 8120 2000/12 ; 8150 2000/05 ; 12140T 1997/00 ; 7110 2002/05 ;

VOLKSWAGEN BUS 8140 CO/CE 1994/01; 13150 2000/06 ; 8150 OD/9150 OD 2001/...8120 OD 2003/...

FORD PICK-UP F1000 1996/98 ; F4000 1993/98

AGRALE TRUCK 7000 DX 1996/02 ; 7500 TDX 1996/04 ; 6000 D 2003/05 ; 6000 D E-Mec 2005/12 ; 8500 E-Tronic 2005/12

8500 E-Mec 2005/09 ; 9200 2003/05 ; 9200 E-Mec 2009/12 ; 8500 1997/05

AGRALE BUS FURGOVAN 8000 2004/11; MA 7.9 2004/12 ; MA 7.0 1996/06 ; MA 8.5 1997/05 ; MA 7.5T 1996/05

VOLARE BUS A8 2000/10 ; V8 2000/12 ; W8 2000/04

MWM 6.10(X10/6 CYL) ASPIRATED E TURBO 6.45L 12V(EURO 2)

VOLKSWAGEN TRUCK 14150 1991/99 ; 14200 1991/94 ; 13180/15180 2000/05 ; 14180 1999/00 ; 23210/17210/15210 2002/06;

12180 1999/01 ; VOLKSWAGEN BUS 16180 CO 1991/97 ; 16210 CO 1997/...17240 OT 2001/04

FORD TRUCK F14000HD 1992/98 ; C-1618 1992/99 ; FORD BUS B-1618/B-1621 1992/99 B-12000 1996/99

AGRALE TRUCK 13000 2007/12 ; VOLVO TRUCK VM17-210/VM17-240/VM23-210/VM23-240 2003/05

MWM 4.10(X10/4CYLINDERS) ASPIRAD AND TURBO 4.3LITER 8VALVES(EURO 2)

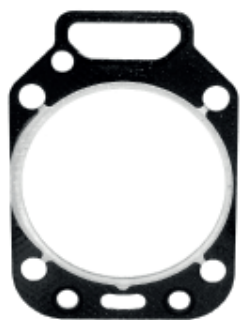

54364904



54360990



54325090

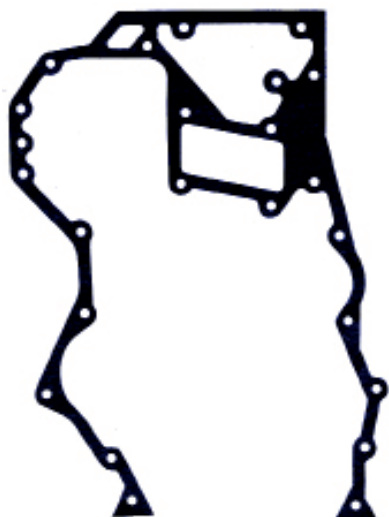

54369590

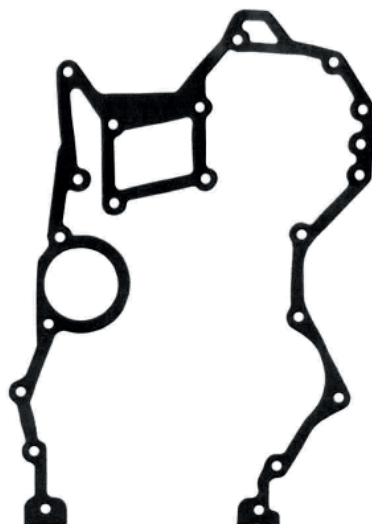

54362590

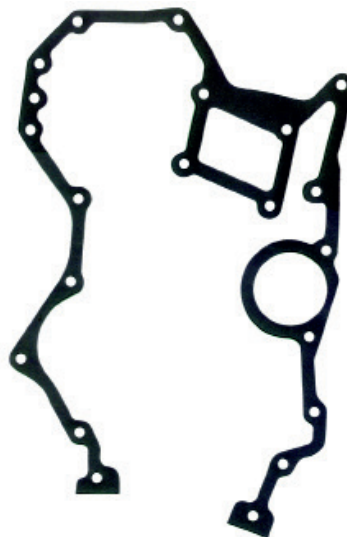

54350790

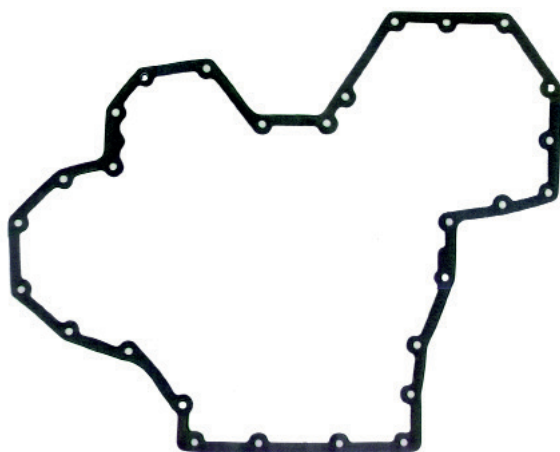

54362690

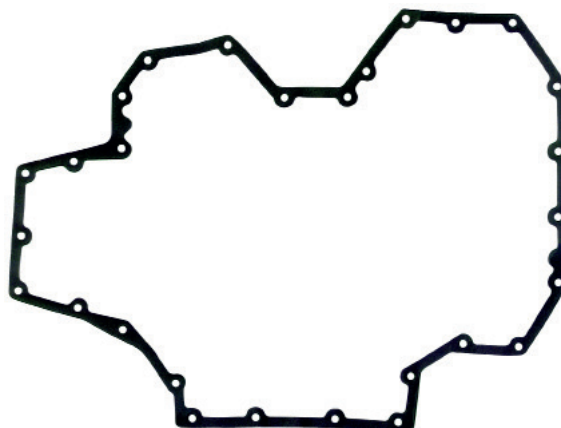

54349790



RE02872S



RE02871S



54355544



54353444

MWM 4.10(X10/4CYLINDERS) ASPIRAD AND TURBO 4.3LITER 8VALVES(EURO 2)

54325117

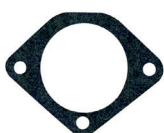

54368316

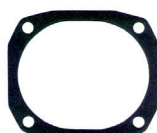

54350690



54355432



5432016



54360516



54351090



54367716



54353816



54353108



54349490



54350990



54353216



54351417



54308490



54308395



54360216



54350590



54349890



54355990



54376845



54360395



RE02927F

84384826 KIT RUBBER		
N° ABR	DESCRIPTION	QTD
50011428	ALUMINIUM	4
50014130	STEEL WASHER 7,3 X 15,0 X 2,0 MM	6
50072928	ALUMINIUM WASHER 10,0 X 16,0 X 1,0 MM	4
50021129	ALUMINIUM WASHER 14,0 X 18,0 X 1,5 MM	15
50008224	COPPER WASHER 14,0 X 18,0 X 1,5 MM	3
50007224	COPPER WASHER 22,0 X 27,0 X 1,5 MM	1
50015428	ALUMINIUM WASHER 10,0 X 13,8 X 1,0 MM	1

84384926 KIT RUBBER		
N° ABR	DESCRIPTION	QTD
50011428	ALUMINIUM WASHER 8,3 X 13,8 X 1,0 MM	6
50014130	STEEL WASHER 7,3 X 15,0 X 2,0 MM	4
50072928	ALUMINIUM WASHER 10,0 X 16,0 X 1,0 MM	2
50021129	ALUMINIUM WASHER 14,0 X 18,0 X 1,5 MM	10
50072424	COPPER WASHER 22,0 X 27,0 X 1,5 MM	1
50070729	ALUMINIUM WASHER 12,0 X 18,0 X 1,5 MM	4
50025429	ALUMINIUM WASHER 18,5 X 24,0 X 1,5 MM	2
50028325	ALUMINIUM WASHER 22,0 X 29,0 X 2,0 MM	1

84385046 KIT RUBBER		
N° ABR	DESCRIPTION	QTD
50026941	SEALER 75,0X3,0 MM	2
50010641	SEALER 24,0X4,0 MM	6
50028941	SEALER 125,8X3,0 MM	1
54388440	SEALER 50,52X1,78 MM	2
50011241	SEALER 34,0X3,0 MM	1
54306241	SEALER 40,0X3,0 MM	2
50005141	SEALER 7,65X1,78 MM	6
50037141	SEALER 14,0X3,0 MM	6
54386440	SEALER 28,0X5,0 MM	2
50010841	SEALER 25,5X2,8 MM	1
54384640	SEALER 86,5X5,3 MM	1
50005741	SEALER 20,0X4,0 MM	1
54388040	SEALER 78,0X2,0 MM	1
50034341	SEALER 11,0X3,4 MM	1

84385126 KIT RUBBER		
N° ABR	DESCRIPTION	QTD
50026941	SEALER 75,0X3,0 MM	1
50010641	SEALER 24,0X4,0 MM	4
50028941	SEALER 125,8X3,0 MM	1
54388440	SEALER 50,52X1,78 MM	2
50011241	SEALER 34,0X3,0 MM	1
54306241	SEALER 40,0X3,0 MM	2
54384640	SEALER 86,5X5,3 MM	1
50005141	SEALER 7,65X1,78 MM	4
50037141	SEALER 14,0X3,0 MM	4
54386440	SEALER 28,0X5,0 MM	2
50002741	SEALER 43,0X50,5X6,5 MM	1

MWM 4.12(X12/4CYLINDERS) TURBO 4.8 LITER 8 VALVES(EURO3)

N° SET		DESCRIPTION					
64315032	FULL GASKET SET 412TCE (X12) 4 CYLINDERS ACTEON WITHOUT OIL SEAL WITH LINER SHIM			1			
74315032	FULL GASKET SET 412TCE (X12) 4 CYLINDERS ACTEON WITH OIL SEAL WITH LINER SHIM			2			
64315042	FULL GASKET SET 612TCE (X12) 6 CYLINDERS ACTEON WITHOUT OIL SEAL			3			
74315042	FULL GASKET SET 612TCE (X12) 6 CYLINDERS ACTEON WITH OIL SEAL			4			
N° ABR	N° ORIGINAL	DESCRIPTION					
RE02927F		VALVE STEM SEAL		12	8		
54308395	961008528014	OIL SEAL GASKET		1	1		
54308490	961008528024	INLET OIL GASKET		1	1		
543107630	961288530014	CYLINDER HEAD SEAL GASKET		6	6	4	4
543119202	961208540034	CYLINDER HEAD GASKET		3	3	2	2
54340367	922908531054	INTAKE MANIFOLD GASKET				1	1
54347319	961283400024	LINER SHIM		6	6	4	4
54349490	941088530324	CHAMBER GASKET DO RESPIRO		1	1	1	1
54349890	941088530334	OIL RADIATOR GASKET		1	1	1	1
54350590	941088530354	INLET WATER NOZZLE GASKET		1	1	1	1
54350990	941088530394	OIL COOLER GASKET		1	1	1	1
54351417	961008530204	EXHAUST MANIFOLD GASKET		6	6	4	4
54352090	961088530354	OIL PAN GASKET		1	1		
54353216	961008530144	EXHAUST MANIFOLD GASKET		6	6	4	4
54353444	961008530034	VALVE COVER GASKETS		6	6	4	4
54355432	961008530214	TURBOCHARGING GASKET		1	1		
54355544	961008530124	FRONT COVER GASKET		4	4	3	3
54360990	941088530374	OIL PAN GASKET				1	1
54367716	961088530384	EXHAUST MANIFOLD GASKET		1	1	1	1
54370667	960788530074	OIL RETURN GASKET				1	1
54376845	904931361131	LINER RING		12	12	8	8
54391477	961208530014	TIMING COVER GASKET		1	1	1	1
54395967	941208530034	OIL RETURN GASKET		1	1	1	1
54396347		COLLECTOR CURVE GASKET		1	1	1	1
54396377	961208530024	INTERMEDIATE DISTRIBUTION GASKET		1	1	1	1
84395826		KIT WASHER				1	1
84395926		KIT WASHER				1	1
84396046		KIT RUBBERS		1	1	1	1
84396146		KIT RUBBERS		1	1	1	1
RE02871S		FRONT OIL SEAL		1		1	
RE02872S		REAR OIL SEAL		1		1	

● SOLD SEPARATELY



MWM 4.12(X12/4CYLINDERS) TURBO 4.8 LITER 8 VALVES(EURO3)

APPLICATION

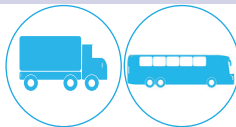

MWM 4.12(X12/4 CYL) TURBO 4.8L 8V(EURO 3)
VOLKSWAGEN TRUCK 13180/15180/17180 2006/12 ; VOLKSWAGEN BUS 15180 EOD 2004/...15190 EOD 2007/..
AGRALE TRUCK 9200 E-TRONIC 2005/12 ; MARRUÁ AM41 2013/...
AGRALE BUS MA 9.2 2004/12 ; MA 7.9 2004/12 ; MA 10.0/MA 15.0 2007/12 ; MA 8.5 2006/12
VOLARE BUS W8 2005/12 ; W9 2006/12 ; D9W 2011/12
VOLVO TRUCK VM17-210/VM23-210 2005/11
MWM 6.12(X12/6 CYL) TURBO 7.2L 12V(EURO 3)
VOLKSWAGEN TRUCK 31260 2005/...
VOLKSWAGEN BUS 17260 EOD 2004/12 ; 17260 EOT 2007/12 ; 17260 OD 2012/...17230/18230 EOD 2007/...17210 EOD 2006/11
VOLVO TRUCK VM260/VM310 2006/12

MWM 4.12(X12/4CYLINDERS) TURBO 4.8 LITER 8 VALVES(EURO3)



543119202



54360990



54352090

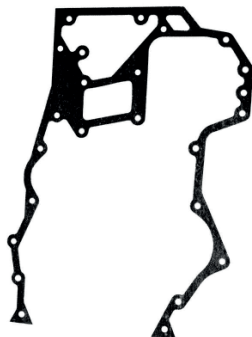

54396377

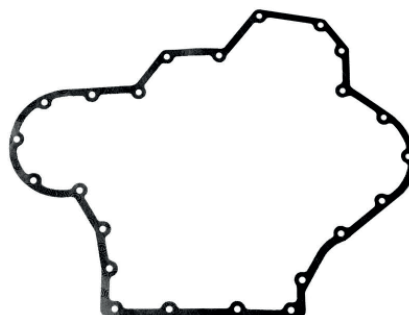

54391477



543107630



54349490



54308490



54308395



58317447



54395967



54349890



54350590



54367716



54351090



54393647



54340367



54351417



54353216



54355432



54325117

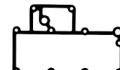

54350990



54376845



54353444



54347319



RE02872S



RE02871S



58317447



RE02927F

84396046		KIT RUBBER	
Nº ABR	DESCRIPTION	QTD	
50026941	SEALER 75,0X3,0 MM	1	
50010641	SEALER 24,0X4,0 MM	4	
543105040	SEALER 17,2X1,8 MM	8	
54387640	SEALER 50,0X3,55 MM	1	
50005541	SEALER 34,0X4,0 MM	1	
54384640	SEALER 86,5X5,3 MM	1	
54305141	SEALER 7,65X1,78 MM	4	
543104840	SEALER 8,2X2,4 MM	1	
54385540	SEALER 35,0X3,0 MM	1	
54387040	SEALER 58,0X2,6 MM	1	
54388040	SEALER 78,0X2,0 MM	1	

84396146		KIT RUBBER	
Nº ABR	DESCRIPTION	QTD	
54387240	SEALER 78,0X3,0 MM	1	
50010641	SEALER 24,0X4,0 MM	6	
543105040	SEALER 17,2X1,8 MM	8	
54387640	SEALER 50,0X3,55 MM	1	
50005741	SEALER 20,0X4,0 MM	1	
54384640	SEALER 86,5X5,3 MM	1	
54305141	SEALER 7,65X1,78 MM	6	
543104840	SEALER 8,2X2,4 MM	1	
54385540	SEALER 35,0X3,0 MM	1	
54387040	SEALER 58,0X2,6 MM	1	
543104940	SEALER 91,6X3,0 MM	1	

84395826		KIT RUBBER	
Nº ABR	DESCRIPTION	QTD	
50026941	SEALER 75,0X3,0 MM		
50010641	SEALER 24,0X4,0 MM		
543105040	SEALER 17,2X1,8 MM		
54387640	SEALER 50,0X3,55 MM		
50005541	SEALER 34,0X4,0 MM		
54384640	SEALER 86,5X5,3 MM		
54305141	SEALER 7,65X1,78 MM		
543104840	SEALER 8,2X2,4 MM		
54385540	SEALER 35,0X3,0 MM		

84395926		KIT RUBBER	
Nº ABR	DESCRIPTION	QTD	
50011428	ALUMINIUM WASHER 8,3X13,8X1,0 MM		
50072429	COPPER WASHER 22,5X26,7X1,5 MM		
50011024	COPPER WASHER 7,3X15,2X2,0 MM		
50029725	ALUMINIUM WASHER 24,0X29,0X2,0 MM		
50028325	ALUMINIUM WASHER 22,0X29,0X2,0 MM		
50012928	COPPER WASHER 8,3X12,0X1,0 MM		
50021129	ALUMINIUM WASHER 14,0X18,0X1,5 MM		
50023329	ALUMINIUM WASHER 16,0X22,0X1,5 MM		
50027329	ALUMINIUM WASHER 20,0X26,0X1,5 MM		
50070729	ALUMINIUM WASHER 12,0X18,0X1,5 MM		

MWM SPRINT 4.07 TCA 4 CYLINDERS 2.8LITER

N° SET		DESCRIPTION						
64315083	FULL GASKET SET MWM SPRINT 4.07 TCA 4 CYLINDERS WITHOUT OIL SEAL		1					
74315083	FULL GASKET SET MWM SPRINT 4.07 TCA 4 CYLINDERS WITH OIL SEAL		2					
74385081	FULL GASKET SET MWM SPRINT 4.07 TCA 4 CYLINDERS WITH OIL SEAL		3					
64315103	FULL GASKET SET MWM SPRINT 4.07 TCA 4 CYLINDERS WITHOUT OIL SEAL		4					
74315103	FULL GASKET SET MWM SPRINT 4.07 TCA 4 CYLINDERS WITH OIL SEAL		5					
74385103	FULL GASKET SET MWM SPRINT 4.07 TCA 4 CYLINDERS WITH OIL SEAL		6					
N° ABR	N° ORIGINAL	DESCRIPTION						
54395700	940708548074	CYLINDER HEAD GASKET				1	1	1
54393744	940708530034	VALVE COVER GASKETS	1	1	1	1	1	1
54369643	940708530084	INTAKE MANIFOLD GASKET				1	1	1
54378167	940708530164	INTAKE MANIFOLD GASKET	1	1	1			
54360777	940788530014	OIL PAN GASKET		1	1		1	1
54370967	960708530084	EXHAUST MANIFOLD GASKET	4	4	4	4	4	4
54370667	960788530074	OIL PIPE GASKET	1	1	1	1	1	1
54368147	940708530054	INTAKE MANIFOLD CURVE GASKET				1	1	1
54360367	941008530094	INJECTION PUMP GASKET					1	1
54370867	940788530094	OIL COOLER GASKET		1	1		1	1
54371247	940708530134	OIL COOLER GASKET					1	1
54367473	940708530124	TIMING COVER GASKET		1	1		1	1
54383267	940788530184	OIL PUMP GASKET		1	1		1	1
54391067	940885300014	OIL COOLER GASKET		1	1			
54396267	94088530034	OIL COOLER FILTER GASKET		1	1			
543101267	94088530014	OIL COOLER FILTER GASKET		1	1			
RE09228F	904960640069	VALVE STEM SEAL	12	12		12	12	
84385726		KIT WASHER				1	1	1
84397026		KIT WASHER	1	1	1			
84385946		KIT RUBBER				1	1	1
84396846		KIT RUBBER	1	1	1			
RE05055F	904960640910	FRONT OIL SEAL		1			1	
RE02629F	904960640643	REAR OIL SEAL		1			1	
54395702		CYLINDER HEAD GASKET MLS	1	1	1			

● SOLD SEPARATELY

APPLICATION

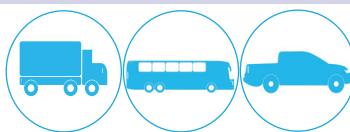

MWM SPRINT 4.07 TCA 4 CYL 2.8L
AGRALE TRUCK 6000 2003/05 ; AGRALE BUS FURGOVAN 6000 1997/05
NISSAN PICK-UP FRONTIER TD/X-TERRA TD 2002/05 ; VOLARE BUS A5 2002/05 ; A6 1998/05
MWM SPRINT 4.07 TCE ELETRONICO 2.8L/4.08 TCE ELETRONICO 4 CYL 3.0L(EURO 3)
VOLKSWAGEN TRUCK DELIVERY 5140/8150/9150 2005/12 ; VOLKSWAGEN BUS 5140 EOD/8150 EOD 2005/..
AGRALE TRUCK 6000 E-TRONIC 2005/12 ; 8500 2010/12 ; MARRUÁ 2006/12 ; AGRALE BUS FURGOVAN 6000 2005/11
NISSAN PICK-UP FRONTIER TD 2005/08 (BRASIL) ; VOLARE BUS V5/V6 2005/12



MWM SPRINT 4.07 TCA 4 CYLINDERS 2.8LITER



54395702



54395700



54393744

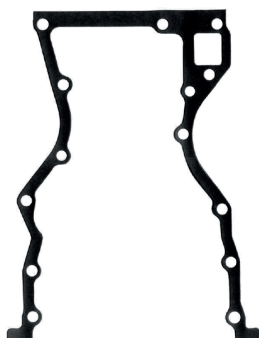

54367473



5436077



54383267



5437816



54369643



543101267



54370667



54396267



54391067



54370967



54368147



54360367



5437067



54370867

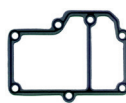

58311632



RE02629F



54355544



RE05055F



RE09228F

MWM SPRINT 4.07 TCA 4CILINDROS 2.8LITER

84385946 KIT RUBBER		
Nº ABR	DESCRIPTION	QTD
543101740	SEALER 32,5X2,65 MM	1
543101840	SEALER 43,7X2,65 MM	2
543102140	SEALER 87,5X3,55 MM	1
543102240	SEALER 28,0X3,55 MM	2
543102340	SEALER 60,0X3,55 MM	1
543103040	SEALER 106,0X3,55 MM	1
543103240	SEALER 41,2X3,55 MM	1
54385840	SEALER 92,5X3,55 MM	1
54390340	SEALER 67,0X3,55 MM	1
543110340	SEALER 53,0X3,55 MM	1
543110440	SEALER 58,0X3,55 MM	1
543110540	SEALER 77,0X3,55 MM	1
543110740	SEALER 85,3X3,55 MM	1
54390640	SEALER 44,8X2,8 MM	1
543103840	SEALER 37,7X60 X 2,7MM	1
543102840	SEALER 82,5X3,55MM	1
543103140	SEALER 80,2X2,5 MM	1
543109740	SEALER 68,0X2,65 MM	2
543103940	SEALER 20,0X2,0 MM	2
54369041	SEALER TAMPA DE VÁLVULA	5
543103440	MANIFOLD SEALER	4

84396846 KIT RUBBER		
Nº ABR	DESCRIPTION	QTD
543101740	SEALER 32,5X2,65 MM	1
543101840	SEALER 43,7X2,65 MM	2
543102040	SEALER 85,0X3,55 MM	1
543102140	SEALER 87,5X3,55 MM	1
543102240	SEALER 28,0X3,55 MM	2
543102340	SEALER 60,0X3,55 MM	1
543103040	SEALER 106,0X3,55 MM	1
543103240	SEALER 41,2X3,55 MM	1
54385840	SEALER 92,5X3,55 MM	1
54390340	SEALER 67,0X3,55 MM	1
54387640	SEALER 50,0X3,55 MM	1
543110340	SEALER 53,0X3,55 MM	1
543110440	SEALER 58,0X3,55 MM	1
543110540	SEALER 77,0X3,55 MM	1
543110640	SEALER 69,0X3,55 MM	1
543110740	SEALER 85,3X3,55 MM	1
54390640	SEALER 44,8X2,8 MM	1
50037141	SEALER 14,0X3,0 MM	4
543103840	SEALER 37,7X60X2,7MM	1
54370741	SEALER 42,5X49X5,8MM	2
50037141	SEALER 14,0X3,0 MM	4
54369041	VALVE COVER SEALER	5
543103440	MANIFOLD SEALER	4

84397026 KIT RUBBER		
Nº ABR	DESCRIPTION	QTD
50951720	COPPER WASHER 7,3X15,3X2,0 MM	4
50011223	COPPER WASHER 8,0X12,0X1,0 MM	5
50015528	ALUMINIUM WASHER 10,0X16,0X1,0 MM	2
50069229	ALUMINIUM WASHER 18,0X22,0X1,5 MM	2
50026729	ALUMINIUM WASHER 20,0X26,0X1,5 MM	3
50026724	COPPER WASHER 20,0X26,0X1,5 MM	3
50028325	ALUMINIUM WASHER 22,0X29,0X2,0 MM	3
50011428	ALUMINIUM WASHER 8,3X13,8X1,0 MM	2
50072429	ALUMINIUM WASHER 22,5X26,7X1,5 MM	2
50023729	ALUMINIUM WASHER 16,0X22,0X1,5 MM	2
50023629	ALUMINIUM WASHER 16,0X20,0X1,5 MM	4
50023624	COPPER WASHER 16,0X20,0X1,5 MM	3
50021129	ALUMINIUM WASHER 14,0X18,0X1,5 MM	6

84385726 KIT RUBBER		
Nº ABR	DESCRIPTION	QTD
50011228	ALUMINIUM WASHER 8,0X12,0X1,0 MM	4
50011223	COPPER WASHER 8,0X12,0X1,0 MM	16
50015728	ALUMINIUM WASHER 10,0X14,0X1,0 MM	1
50070729	ALUMINIUM WASHER 12,0X18,0X1,5 MM	2
50069229	ALUMINIUM WASHER 28,0X22,0X1,5 MM	2
50027129	ALUMINIUM WASHER 20,0X24,0X1,5 MM	1
50028325	ALUMINIUM WASHER 22,0X29,0X2,0 MM	1
50011428	ALUMINIUM WASHER 8,3X13,8X1,0 MM	1
50012938	STEEL WASHER 8,3X11,4X1,0 MM	4
50026729	ALUMINIUM WASHER 20,0X26,0X1,5 MM	1
50021129	ALUMINIUM WASHER 14,0X18,0X1,5 MM	1
50023629	ALUMINIUM WASHER 16,0X20,0X1,5 MM	1
50072429	ALUMINIUM WASHER 22,5X26,7X1,5 MM	1

MWM SPRINT 6.07 TCA 6 CYLINDERS 4.2LITER

N° SET		DESCRIPTION		
64315093	FULL GASKET SET MWM 6.07 6CYLINDERS GM 3500/SILVERADO FORD F4000 WITHOUT OIL SEAL			1
74315093	FULL GASKET SET MWM 6.07 6CYLINDERS GM 3500/SILVERADO FORD F4000 WITH OIL SEAL			2
74335093	FULL GASKET SET MWM 6.07 6CYLINDERS GM 3500/SILVERADO FORD F4000 WITH OIL SEAL			3
N° ABR	N° ORIGINAL	DESCRIPTION		
RE09228F	904960640069	VALVE STEM SEAL	18	18
54395800	960708548164	CYLINDER HEAD GASKET	1	1 1
54370967	960708530084	EXHAUST MANIFOLD GASKET	6	6 6
54370667	960788530074	OIL PIPE GASKET	1	1 1
54370867	940788530094	OIL COOLER GASKET		1 1
54367473	940708530124	CHAMBER GASKET		1 1
54371247	940708530134	OIL COOLER GASKET		1 1
54383267	940788530184	OIL PUMP GASKET		1 1
54369750	960708530064	INTAKE MANIFOLD GASKET	1	1 1
54370467	960788530054	INTAKE MANIFOLD GASKET	1	1 1
54393840	960708530014	VALVE COVER GASKET	1	1 1
54360367	941008530094	INJECTION PUMP GASKET		1 1
54376990	960708530094	OIL PAN GASKET		1 1
54391067	940885300014	OIL COOLER GASKET		1 1
54368147	940708530054	INTAKE MANIFOLD CURVE GASKET		1 1
84386046		KIT RUBBERS	1	1 1
84385826		KIT WASHERS	1	1 1
RE05055F	904960640910	FRONT OIL SEAL		1
RE02029F	904960640643	REAR OIL SEAL		1

• SOLD SEPARATELY

APPLICATION



MWM SPRINT 6.07 TCA 6 CYL 4.2L

FORD TRUCK F250 1999/2006

CHEVROLET TRUCK GMC3500 HD/GMC6150 1997/02



WMW SPRINT 6.07 6 CYLINDERS 4.2LITER



54395800

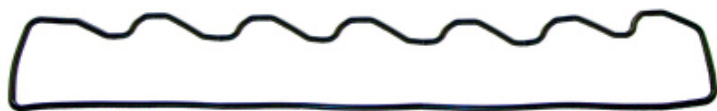

54393940



54376990



543693840

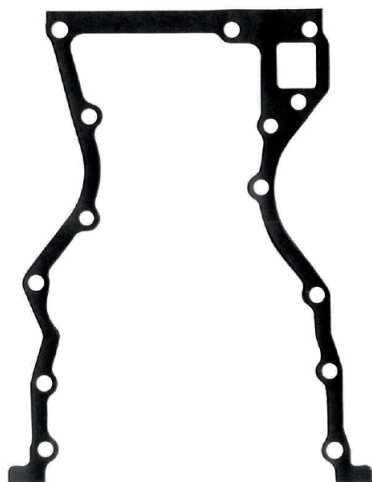

54367473



54383267

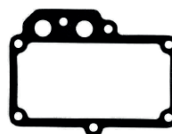

54370867

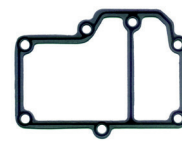

54371247



RE02629F



RE05055F

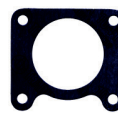

54370467



54360367



54368147



54370967



54391067



54370667



RE09228F

WMW SPRINT 6.07 6CYLINDERS 4.2LITER

84372658

MWM X10 4 CYLINDERS E 6 CYLINDERS WITH OIL SEAL

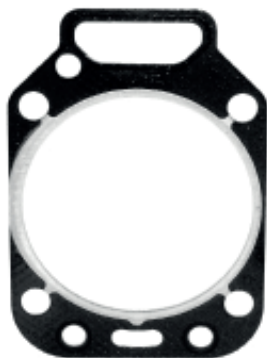

84372558

MWM D/TD229 4 CYLINDERS E 6 CYLINDERS WITH OIL SEAL

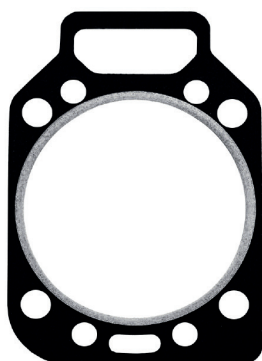

84386046

KIT RUBBER

N° ABR	DESCRIPTION	QTD
543102740	SEALER 31,5X2,65 MM	1
543102040	SEALER 85,0X3,55 MM	1
543102240	SEALER 28,0X3,55 MM	3
543102340	SEALER 60,0X3,55 MM	1
543103040	SEALER 106,0X3,55 MM	1
543103240	SEALER 41,2X3,55 MM	1
54385840	SEALER 92,5X3,55 MM	1
54390340	SEALER 67,0X3,55 MM	1
54387640	SEALER 50,0X3,55 MM	1
543110340	SEALER 53,0X3,55 MM	1
543110440	SEALER 58,0X3,55 MM	1
543110540	SEALER 77,0X3,55 MM	1
543102840	SEALER 82,3X3,55 MM	1
54390640	SEALER 44,8X2,8 MM	1
543103340	SEALER 33,0X3,0 MM	1
54370741	SEALER 42,5X49X5,8MM	1
543103140	SEALER 80,2X2,5 MM	1
54369041	VALVE COVER SEALER	7
543103440	MANIFOLD SEALER	6
54385640	SEALER 40,0X5,0 MM	2
543102440	SEALER 13,2X1,8 MM	2
543102540	SEALER 22,5X2,65 MM	1
543102940	SEALER 103,0X3,55 MM	1

84397026

KIT RUBBER

N° ABR	DESCRIPTION	QTD
50009923	COPPER WASHER 6,2X10,2X1,0 MM	1
50011228	ALUMINIUM WASHER 8,0X12,0X1,0 MM	4
50011223	ALUMINIUM WASHER 8,0X12,0X1,0 MM	24
50015728	ALUMINIUM WASHER 10,0X14,0X1,0 MM	1
50070729	ALUMINIUM WASHER 12,0X18,0X1,5 MM	2
50069229	ALUMINIUM WASHER	2
50027129	COPPER WASHER 20,0X24,0X1,5 MM	1
50028325	ALUMINIUM WASHER 22,0X29,0X2,0 MM	1
50011428	ALUMINIUM WASHER 8,3X13,8X1,0 MM	1
50012938	ALUMINIUM WASHER 8,3X11,4X1,0 MM	18

MWM MAX FORCE 4 CYLINDERS TURBO 4.8LITER 16VALVES(EURO 5)

Nº SET	DESCRIPTION
64315145	FULL GASKET SET X12 4VALVULAS 4CYLINDERS EURO V WITHOUT OIL SEAL
74315145	FULL GASKET SET MAXIFORCE X12 4VALVULAS 4CYLINDERS EURO V WITH OIL SEAL
74335145	HEAD GASKET SET MAXIFORCE X12 4VALVULAS 4CYLINDERS EURO V WITH OIL SEAL
64315165	FULL GASKET SET MAXIFORCE X12 4VALVULAS 6CYLINDERS EURO V WITHOUT OIL SEAL
74315165	FULL GASKET SET MAXIFORCE X12 4VALVULAS 6CYLINDERS EURO V WITH OIL SEAL
74335165	HEAD GASKET SET X12 4VALVULAS 6 CYLINDERS EURO V WITH OIL SEAL
84335465	MONOCYLINDER GASKET SET MWM MAXIFORCE X12 4V EURO V WITH OIL SEAL

Nº ABR	Nº ORIGINAL	DESCRIPTION							
543122705	7002797C1	CYLINDER HEAD GASKET	1	6	6	6	4	4	4
543106830	7002390C1	FRONT COVER GASKET			1	1		1	1
543111130	7002858C1	OIL COOLER GASKET			1	1		1	1
54360977		OIL PAN GASKET						1	1
543105867		OIL PAN GASKET			1	1			
543122847	9612085300114	OIL COOLER GASKET			1	1		1	1
543122947	9612085300124	OIL COOLER GASKET			1	1		1	1
543101569	9612085300144	EXAHUST GASKET	1	6	6	6	4	4	4
543101447	9612088530134	INTAKE MANIFOLD GASKET	1	6	6	6	4	4	4
84397626		REAR KIT WASHERS			1	1		1	1
84397726		HEAD KIT WASHERS		1	1	1	1	1	1
84397846		REAR KIT RUBBERS		1	1		1	1	
84397946		HEAD KIT RUBBERS		1	1	1	1	1	1
RE09105T		FRONT OIL SEAL			1			1	
RE02872F		REAR OIL SEAL			1			1	
RE09109F		VALVE STEM SEAL	4	24	24		16	16	
54367077	941088530444	INLET OIL GASKET		1	1	1	1	1	1
543112204	7000201C1	INTAKE MANIFOLD CURVE GASKET		1	1	1	1	1	1
543106540	961208530104	VALVE COVER GASKETS	1	6	6	6	4	4	4
543200032	7002389C2	TURBO GASKET		1	1	1	1	1	1
54366577	941088530454	OIL SEAL GASKET		1	1	1	1	1	1
50011024	7,3X15,0X2,0 MM	WASHER	1						

• SOLD SEPARATELY



MWM MAXXFORCE 4CYLINDERS TURBO 4.8LITER 16VALVES(EURO 5)

APPLICATION

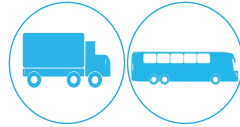

MWM MAXXFORCE 4 CYL TURBO 4.8L 16V(EURO 5)
AGRALE TRUCK 10000 2013/...10000 LX/14000 LX 2016/17
AGRALE BUS MA 9.2/MA 10.0/MA 12.0/MA 15.0 2013/...
VOLARE BUS W9 FLY/DW9 FLY/W8 FLY 2012/14 ; WL FLY 2013/14 ; W9/DW9/W8/WL 2014/...
MWM MAXXFORCE 6 CYL TURBO 7.2L 24V(EURO 5)
AGRALE BUS MA 17.0 2013/...
VOLVO TRUCK VM220/270/330 2012/...

MWM MAX FORCE 4CYLINDERS TURBO 4.8LITER 16VALVES(EURO 5)



543122705

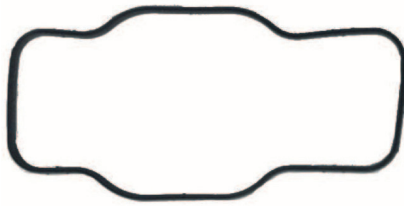

543106540



54360990



543106830



543105867

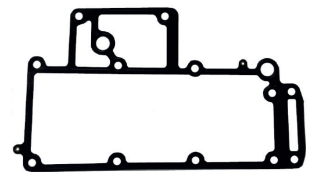

543111130



543122847



543122947



543101569



543101569



543101569



543101569



543101447



543200032



543101569



543101569



50011024



543101569

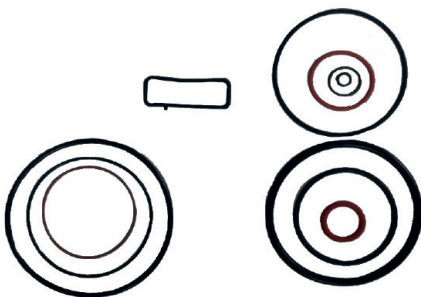

84397946

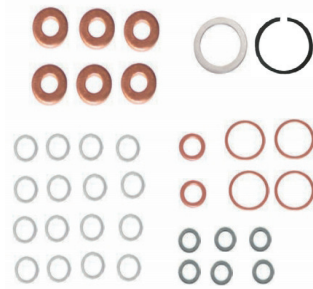

84397726



84397846

 **MAXION PERKINS**

MAXION

Nº ABR	ENGINE	DESCRIPTION	PAGE
70910572	NGD 3.0	FULL GASKET SET WITH OIL SEAL	116
70930572	NGD 3.0	HEAD GASKET SET WITH OIL SEAL	116
60910359	3152	FULL GASKET SET WIT INDIRECT INJECTION WITHOUT OIL SEAL	118
70910359	3152	FULL GASKET SET WIT INDIRECT INJECTION WITH OIL SEAL	118
70930359	3152	FULL GASKET SET WIT INDIRECT INJECTION WITH OIL SEAL	118
60910361	D3152	FULL GASKET SET WIT INDIRECT INJECTION WITHOUT OIL SEAL	124
70910361	D3152	FULL GASKET SET WIT INDIRECT INJECTION WITH OIL SEAL	124
60930361	D3152	FULL GASKET SET WIT INDIRECT INJECTION WITHOUT OIL SEAL	118
70910831	4203	FULL GASKET SET WIT INDIRECT INJECTION WITHOUT OIL SEAL	122
70932931	4203	FULL GASKET SET WIT INDIRECT INJECTION WITHOUT OIL SEAL	128
60912931	4203	FULL GASKET SET WIT INDIRECT INJECTION WITHOUT OIL SEAL	128
70912931	4203	FULL GASKET SET WIT INDIRECT INJECTION WITHOUT OIL SEAL	122
60913001	4203	FULL GASKET SET WIT INDIRECT INJECTION WITHOUT OIL SEAL	126
70913001	4203	FULL GASKET SET WIT INDIRECT INJECTION WITHOUT OIL SEAL	132
70932791	4203	HEAD GASKET SET WIT INDIRECT INJECTION WITHOUT OIL SEAL	126
60912981	D4236/4238	FULL GASKET SET WITHOUT OIL SEAL	130
70912981	D4236/4238	FULL GASKET SET WITH OIL SEAL	136
70913981	T4236	FULL GASKET SET WITH OIL SEAL	136
60913031	T4236	FULL GASKET SET WITHOUT OIL SEAL	130
60916151	D4236/4248	FULL GASKET SET WITHOUT OIL SEAL	134
70916151	D4236/4248	FULL GASKET SET WITH OIL SEAL	140
70916151	4236 / 4248	FULL GASKET SET WITH OIL SEAL	140
70933031	4236 / 4248	HEAD GASKET SET WITH OIL SEAL	134
70930051	4236 / 4248	FULL GASKET SET WITH OIL SEAL	138
60910151	Q20B/4236	FULL GASKET SET WITHOUT OIL SEAL	144
70910151	Q20B/4236	FULL GASKET SET WITH OIL SEAL	144
60930051	Q20B/D4236/4248	FULL GASKET SET WITHOUT OIL SEAL	138
70930051	Q20B/D4236/4248	FULL GASKET SET WITH OIL SEAL	142
60914763		FULL GASKET SET WITHOUT OIL SEAL	148
70914763		FULL GASKET SET WITH OIL SEAL	148
60934763		HEAD GASKET SET WITHOUT OIL SEAL	148
60914053		FULL GASKET SET WITHOUT OIL SEAL	148
70914053		FULL GASKET SET WITH OIL SEAL	142
60934053		HEAD GASKET SET WITHOUT OIL SEAL	146
60914753	P4000/94000T	FULL GASKET SET WITHOUT OIL SEAL	152
70914753	P4000/94000T	FULL GASKET SET WITH OIL SEAL	146
70934751	P4000/94000T	FULL GASKET SET WITH OIL SEAL	150
60914733	S4/S4T	FULL GASKET SET WITH OIL SEAL	156
70914733	S4/S4T	FULL GASKET SET WITH OIL SEAL	150
70934731	S4/S4T	HEAD GASKET SET WITH OIL SEAL	154
60914773	HS 2.5	FULL GASKET SET WITHOUT OIL SEAL	160
70914773	HS 2.5	FULL GASKET SET WITH OIL SEAL	160
60934773	HS 2.5	HEAD GASKET SET WITHOUT OIL SEAL	154
70934773	HS 2.5	HEAD GASKET SET WITH OIL SEAL	158
60914873	HS 2.8	FULL GASKET SET WITH OIL SEAL	164
70914873	HS 2.8	FULL GASKET SET WITH OIL SEAL	164
60934873	HS 2.8	HEAD GASKET SET WITH OIL SEAL	158
70934873	HS 2.8	HEAD GASKET SET WITH OIL SEAL	162
60913761	P6354.4	FULL GASKET SET WITH OIL SEAL	168
70913761	P6354.4	FULL GASKET SET WITH OIL SEAL	168
70933761	P6354.4	HEAD GASKET SET WITH OIL SEAL	162
60913763	P6354.4	FULL GASKET SET WITHOUT OIL SEAL	166
60913761	P6354.4	FULL GASKET SET WITHOUT OIL SEAL	172
70913761	P6354.4	FULL GASKET SET WITH OIL SEAL	172
70933761	P6354.4	FULL GASKET SET WITH OIL SEAL	166
60913763	P6354.4	HEAD GASKET SET WITHOUT OIL SEAL	170
60912881	P6357	FULL GASKET SET WITH OIL SEAL	176
70912881	P6357	FULL GASKET SET WITH OIL SEAL	170
70932881	P6357	HEAD GASKET SET WITH OIL SEAL	174
60913439	P6358	FULL GASKET SET WITHOUT OIL SEAL	174
70913439	P6358	FULL GASKET SET WITH OIL SEAL	174
70933431	P6358	HEAD GASKET SET WITH OIL SEAL	174

N° SET		DESCRIPTION		
70910572		FULL GASKET SET PERKINS NGD 30 POWER STROKE WITH OIL SEAL	1	
70930572		HEAD GASKET SET PERKINS NGD 30 POWER STROKE WITHOUT OIL SEAL	2	
N° ABR	N° ORIGINAL	DESCRIPTION		
50951720	7X5,153X1,98	WASHER	4	4
50984740	70490701	VALVE COVER GASKET	1	1
50980967	70490705	FRONT COVER GASKET		1
50985302	70490185	CYLINDER HEAD GASKET	1	1
50980440	70490709	OIL PAN TUBE GASKET		1
50980540	70490708	TIMING COVER GASKET		1
50980667	70490690	OIL COOLER GASKET		1
50981040	70490704	WATER PUMP GASKET	1	1
50981367	70490703	FRONT COVER GASKET		1
50981431	70490785	INTAKE EXHAUST MANIFOLD GASKET	4	4
50981531	3688C002	INTAKE MANIFOLD GASKET	4	4
50981867	70490692	WATER PUMP TUBE GASKET		1
50984940	70590020	WATER PUMP GASKET	1	1
50985740	70590021	INSPECTION COVER GASKET	1	1
50987340	70490814	FUEL PUMP GASKET		1
50992667		OIL RETURN TUBE GASKET		1
50992940	70490700	VALVE COVER SEAL GASKET	4	4
50997240	70490823	TIMING COVER GASKET		1
50997840	70490824	TIMING COVER GASKET		1
RE09101S		HEAD OIL SEAL		
RE05239F		REAR OIL SEAL		
RE09102F		VALVE STEM SEAL	16	16

• SOLD SEPARATELY

APPLICATION



FORD RAMGER 16VALVE 2005/...

TROLLER T4 2006/...

MAXION PERKINS INTERNACIONAL NGD 3.0 POWERSTROKE



50985302

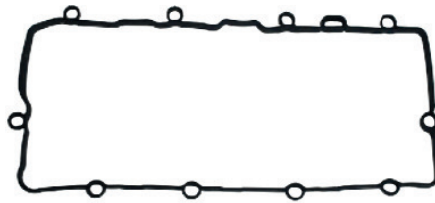

50984740



50980667



50980967



50981531



RE05239F



50992667



50981867



50981431

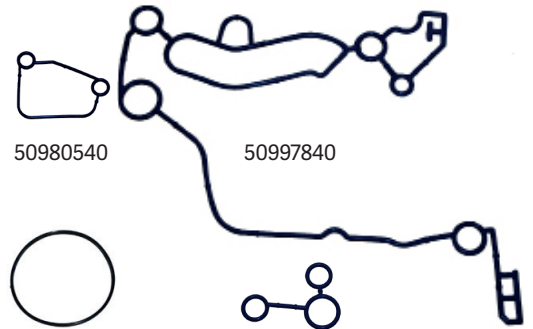

50980540

50997840

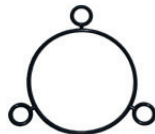

50987340



50992940



50981040



50984940



50997240



RE09101S



50985740



50980440



50951720



50981367



RE09102F

N° SET	DESCRIPTION
60910359	FULL GASKET SET PERKINS 3152 INDIRECT INJECTION WITHOUT OIL SEAL 1
70910359	FULL GASKET SET PERKINS 3152 INDIRECT INJECTION WITH OIL SEAL 2
70930359	HEAD GASKET SET PERKINS 3152 INDIRECT INJECTION WITHOUT OIL SEAL 3
60910361	FULL GASKET SET PERKINS D3152 INDIRECT INJECTION WITHOUT OIL SEAL 4
70910361	FULL GASKET SET PERKINS D3152 INDIRECT INJECTION WITH OIL SEAL 5
60930361	FULL GASKET SET PERKINS D3152 INDIRECT INJECTION WITHOUT OIL SEAL 6

N° ABR	N° ORIGINAL	DESCRIPTION						
50900898	70490378	THERMOSTATIC GASKET	1	1	1	1	1	1
50907190	0490251	OIL PAN GASKET						1 1
50909016	70490353	EXHAUST GASKET					2	2 2
50909190	70490354	THERMOSTATS GASKET	1	1	1	1	1	1 1
50909290	70490354	WATER PUMP GASKET			1	1		1 1
50909390	70490355	REAR CYLINDER COVER GASKET	1	1	1	1	1	1 1
50909490	70490356	INLET WATER CONECTION GASKET			1	1		1 1
50909550	00490491	VALVE COVER GASKET					1	1 1
50911098	70490361	INTAKE MANIFOLD GASKET					1	1 1
50911298	70490357	OIL FILTER GASKET			1	1		1 1
50911509	70490822	CYLINDER HEAD GASKET					1	1 1
50912090	70490364	INSPECTION COVER GASKET			1	1		1 1
50912298	75490367	REAR COVER GASKET			1	1		1 1
50912990	70490313	OIL SEAL COVER GASKET						1 1
50913496	70490034	HYDRAULIC PUMP COVER GASKET			1	1		1 1
50914198	70490381	FUEL LIFT PUMP GASKET						1 1
50914290	70490382	ACTUATOR TACHIMETER GASKET			1	1		1 1
50914396	70490343	INSPECTION COVER GASKET	1	1	1			1 1
50916098	70490063	COUPLING INJECTION PUMP GASKET			1	1		1 1
50923816	70490014	OUTLET EXHAUST MANIFOLD GASKET	1	1	1	1		1 1
50926698	70490316	FUEL LIFT PUMP GASKET			1	1		
50934616	70490373	OUTLET EXHAUST MANIFOLD GASKET	1	1	1			
50949316	70490737	INTAKE EXHAUST MANIFOLD GASKET	2	2	2			
50949498	70490419	INTAKE MANIFOLD GASKET	1	1	1			
50949898	33826111	OIL FILTER COVER GASKET			1	1		
50950548		BEARING GASKET						2 2
50953055	36711115	VALVE COVER GASKET	1	1	1			
50954898	70490321	WATER PUMP GASKET	1	1	1			
50971501	70490821	CYLINDER HEAD GASKET	1	1	1			
80903226		KIT WASHERS					1	1 1
80903326		KIT WASHERS	1	1	1			
80919350		KIT OIL PAN GASKET						1 1
80966190		KIT OIL PAN GASKET			1	1		
RE00013S	70730016	HEAD OIL SEAL			1			1
RE01972S		REAR OIL SEAL			1			
RE00572S	30854	REAR OIL SEAL						1

● SOLD SEPARATELY

3152 / D3152

APPLICATION



PERKINS P3152 INDIRECT INJECTION 3 CYL 2.4L

MASSEY FERGUSON TRACTOR MF 50X 1963/74 MF 55X 1974/...MF 235 1975/78 MF 250 1975/99 MF 350 1975/...

PERKINS P3152 DIRECT INJECTION 3 CYL 2.4L

MASSEY FERGUSON TRACTOR MF 235 1980/98

3152 / D3152

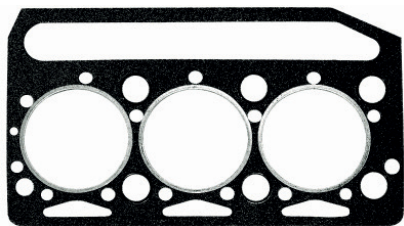

50911509

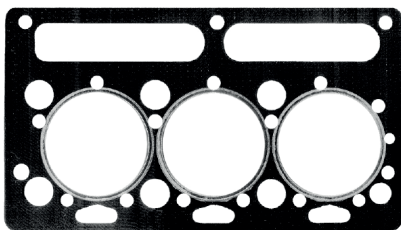

50971501

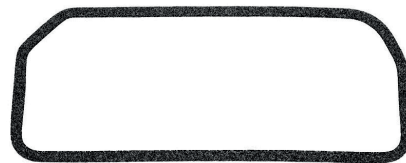

50909550

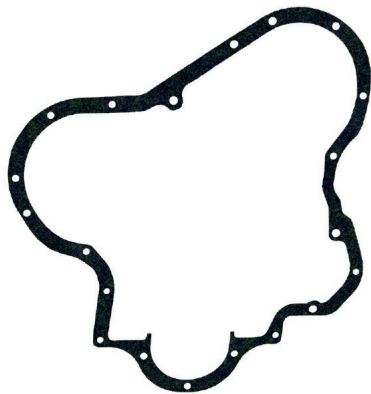

50912090

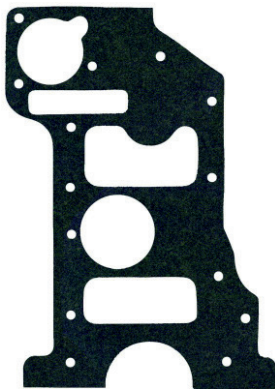

50912298

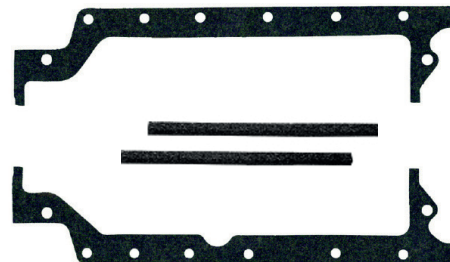

80966190



50953055



50949498

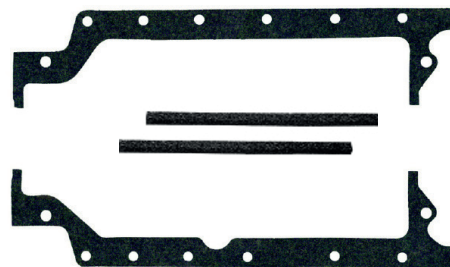

80919350

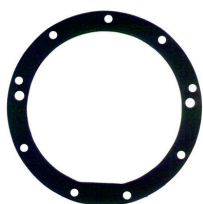

50949808

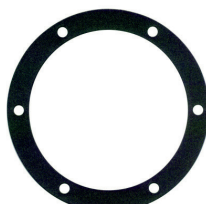

50907190



50909190

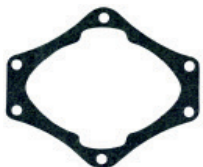

50912990

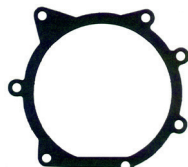

50954898



50914396

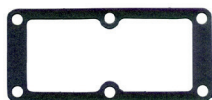

50909390

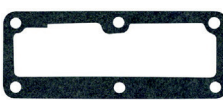

50911098

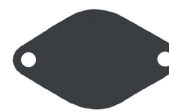

50913496

3152 / D3152



50934616



50923816



50914290



50909290



50900898



50909016



50916098



50949316



50926698



50914198



50909490



50911298



RE01972S



RE00013S



RE00572S



50950548

80903226		KIT RUBBER	
N° ABR	DESCRIPTION	QTD	
50022224	WASHER 14,0X20,8X1,5 MM	3	
50035623	COPPER WASHER 40,3X46,7X1,0 MM	3	
50906541	VALVE STEM SEAL	6	

80903326		KIT RUBBER	
N° ABR	DESCRIPTION	QTD	
50937620	WASHER 10,0X19,2X2,0 MM	3	
50962240	INJECTION PORT SEAL	3	

4203 INDIRECT INJECTION

N° SET		DESCRIPTION				
70910831	FULL GASKET SET 4203 INDIRECT INJECTION WITH OIL SEAL		1			
70932931	HEAD GASKET SET 4203 INDIRECT INJECTION WITH OIL SEAL		2			
60912931	FULL GASKET SET 4203 INDIRECT INJECTION WITHOUT OIL SEAL		3			
70912931	FULL GASKET SET 4203 INDIRECT INJECTION WITH OIL SEAL		4			
N° ABR	N° ORIGINAL	DESCRIPTION				
50906990	00490042	INTAKE MANIFOLD GASKET	1	1	1	1
50907016	70490818	INTAKE EXHAUST MANIFOLD GASKET	2	2	2	2
50909390	70490355	REAR CYLINDER COVER GASKET	1	1	1	1
50910198	0490692	INLET WATER CONECTION GASKET	1	1		1
50910250	70490401	CAM AXLE SEAL	1	1		1
50910390	70490359	OUTLET WATER CONECTION GASKET	1	1	1	1
50910450	00490704	VALVE COVER GASKET	1	1	1	1
50910590	0490706	WATER PUMP TUBE GASKET	1	1		1
50910698	0490707	INJECTION PUMP GASKET	1	1	1	1
50910798	70490360	BY PASS CONECTION GASKET	1	1	1	1
50911298	70490357	OIL FILTER GASKET	1	1		1
50911398	70490724	INSPECTION COVER GASKET	1	1		1
50911601	70490411	CYLINDER HEAD GASKET	1	1	1	1
50911898	70490310	INSPECTION COVER GASKET				1
50912198	70490366	BOX DISTRIBUTION GASKET				1
50912990	70490313	OIL SEAL COVER GASKET	1	1		1
50913098	36817141	OIL SEAL COVER GASKET	1	1		1
50913394	36835412	HYDRAULIC PUMP GASKET	1	1		1
50913550	36846114	INSPECTION COVER GASKET TUCHAS	1	1	1	1
50913650	36846409	INSPECTION COVER GASKET				1
50913850	36851107	FRONT COVER GASKET	1	1	1	1
50914198	70430381	FUEL LIFT PUMP GASKET	1	1		1
50914396	70490343	INSPECTION COVER GASKET	1	1		1
50914490	36865108	TIMING COVER GASKET	1	1		1
50914590	36866414	TIMING COVER GASKET				1
50914698	70490342	WATER PUMP GASKET	1	1		1
50915290	70490391	INSPECTION COVER GASKET	1	1		1
50916098	70490063	COUPLING INJECTION PUMP GASKET	1	1		1
50918098	70490011	OIL PUMP GASKET				1
50923290	36853105	INJECTOR OIL PUMP GASKET				1
50923816		OUTLET EXHAUST MANIFOLD GASKET	1	1	1	1
50923990	70490324	BOX DISTRIBUTION GASKET	1	1		1
50933816	80490032	OUTLET EXHAUST GASKET	1	1	1	1
50950567	70730023	REAR BEARING GASKET	2	2		2
50959098	70490109	BOX DISTRIBUTION GASKET				1
80903426		KIT WASHERS	1	1	1	1
80924550		OIL PAN GASKET				1
80924694		OIL PAN GASKET	1	1		1
RE00013N		HEAD OIL SEAL	1			1
RE00572S	30554	OIL PAN SEALER	1			1

• SOLD SEPARATELY

4203 INDIRECT INJECTION

APPLICATION



PERKINS P4203 INDIRECT INJECTION 4 CYL 3.3L

FORD TRACTOR 8BR 1961/67

PERKINS P4203 INDIRECT INJECTION 4 CYL 3.3L

MASSEY FERGUSON TRACTOR MF 65 1965/82 CBT TRACTOR 1000 1975/...CASE TRACTOR 580E 1972/85

4203 INDIRECT INJECTION

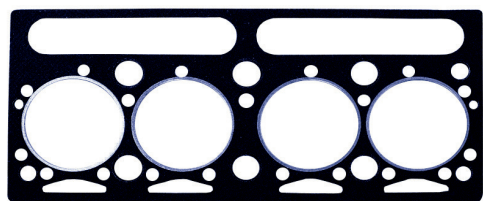

50911601

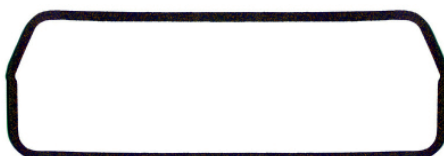

50910450



50906990

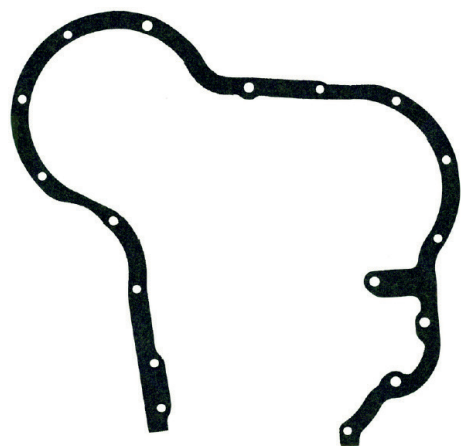

50915290

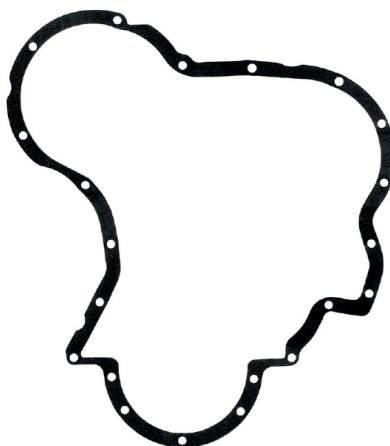

50911898



50913650

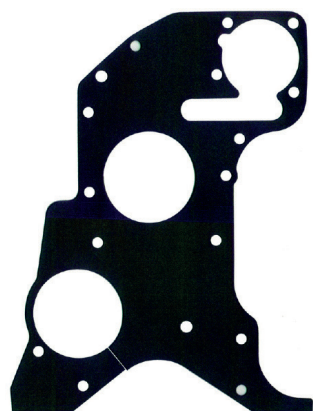

50912198

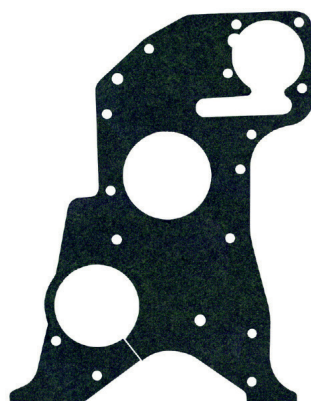

50923990

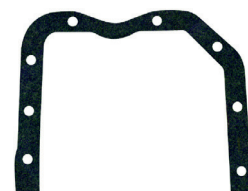

50914490

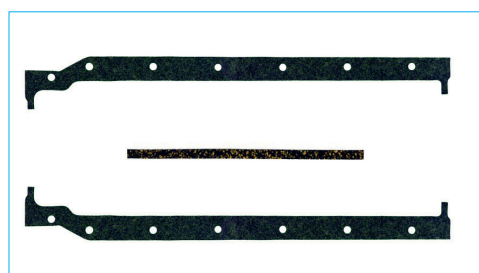

80924550

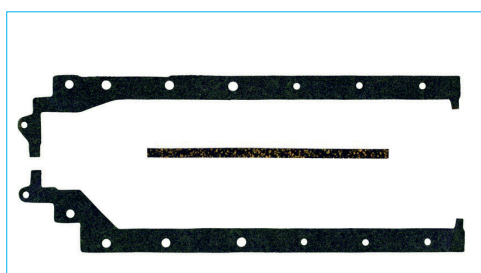

80924694

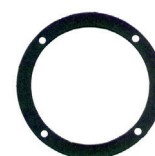

50911398

4203 INDIRECT INJECTION



50933816



50907016



50913394



50918098



50910698



50914198



50910198



550910250



50923816



50910590



50916098



50911298



50914698



50959098



50913098



50914396



50923290



50910390



50909390



50914590



50913550



50913850



50910798

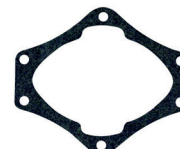

50912990



RE00013N



RE00572S



50950567

80903426

KIT RUBBER

N° ABR	DESCRIPTION	QTD
50022224	WASHER 14,0X20,8X1,5 MM	4
50036623	COPPER WASHER 40,3X46,7X1,0 MM	4
50906541	VALVE STEM SEAL	8
50010341	SEAL 23,0X3,5 MM	1

4203 DIRECT INJECTION

N° SET		DESCRIPTION			
60913001	FULL GASKET SET 4203 DIRECT INJECTION WITHOUT OIL SEAL		1		
70913001	FULL GASKET SET 4203 DIRECT INJECTION WITH OIL SEAL		2		
70932791	HEAD GASKET SET 4203 DIRECT INJECTION WITH OIL SEAL		3		
N° ABR	N° ORIGINAL	DESCRIPTION			
50900316	70490344	INTAKE EXHAUST MANIFOLD GASKET	2	2	2
50900450	36811112	VALVE COVER GASKET	1	1	1
50909398	70490355	BOTTOM CYLINDER COVER GASKET	1	1	1
50910198	70490692	INLET WATER CONECTION GASKET		1	1
50910390	70490359	OUTLET WATER PUMP GASKET	1	1	1
50910590	70490706	INJECTOR PUMP GASKET		1	1
50910698	70490707	CONNECTION WATER PUMP GASKET (HEAD)	1	1	1
50910798	70490360	START ENGINE GASKET	1	1	1
50911298	70490357	OIL FILTER GASKET		1	1
50911701	70490742	CYLINDER HEAD GASKET	1	1	1
50910250	70490343	CAM AXLE SEAL		1	1
50914198	70490381	HEAD FULL PUMP GASKET		1	1
50914396	70490343	INSPECTION COVER GASKET		1	1
50914490	36865108	TIMING COVER GASKET		1	1
50914698	70490342	WATER PUMP GASKET		1	1
50914798	70490388	INTAKE MANIFOLD GASKET	1	1	1
50915290	70490391	TIMING COVER GASKET		1	1
50916098	70490063	INJECTED PUMP GASKET		1	1
50923816	70490014	OUTLET EXHAUST MANIFOLD GASKET	1	1	1
50923990	70490324	BOX DISTRIBUTION GASKET		1	1
50933816	70490014	OUTLET EXHAUST MANIFOLD GASKET	1	1	1
50950567	70730023	GASKET		2	2
50966140	2415745	O RING GASKET		1	1
80903690		KIT WASHER RUBBER	1	1	1
80924694		OIL PAN GASKET		1	1
RE00013S	70730016	HEAD OIL SEAL		1	
RE00572S	30854	REAR OIL SEAL		1	

• SOLD SEPARATELY

4203 DIRECT INJECTION

APPLICATION



PERKINS P4203 INDIRECT INJECTION 4 CYL 3.3L

FORD TRACTOR 8BR 1961/67

PERKINS P4203 INDIRECT INJECTION 4 CYL 3.3L

MASSEY FERGUSON TRACTOR MF 65 1965/82 CBT TRACTOR 1000 1975/...CASE TRACTOR 580E 1972/85

4203 DIRECT INJECTION

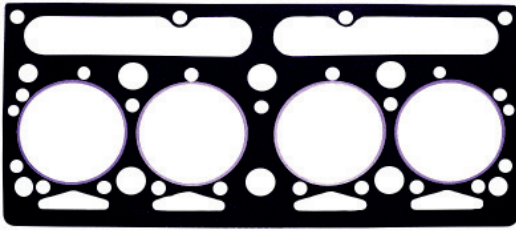

50911701

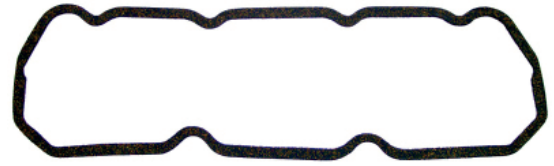

50900450

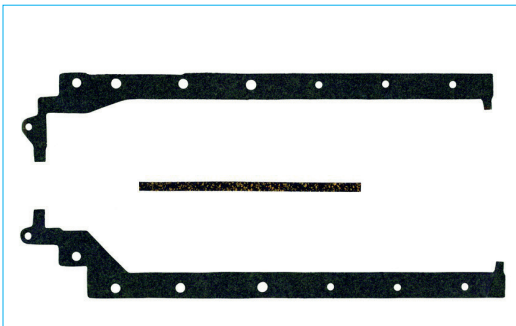

80924694



50914798

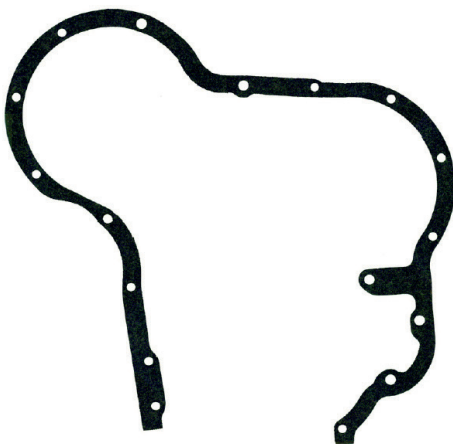

50915290

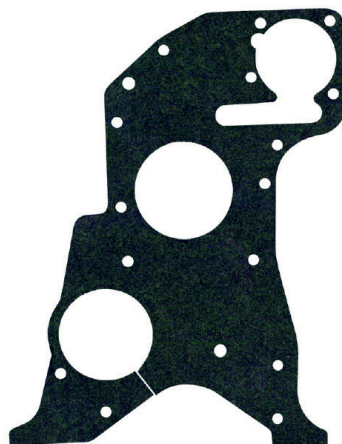

50923990

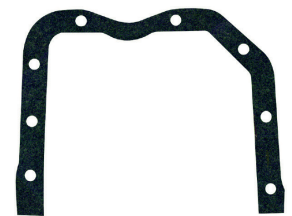

50914490

4203 DIRECT INJECTION



80903690		KIT RUBBER
Nº ABR	DESCRIPTION	QTD
50937620	WASHER 10,0X19,2X2,0 MM	4
50010341	SEAL 23,0X3,5 MM	1
50062240	INJECTOR SEALER	4

N° SET		DESCRIPTION				
60912981		FULL GASKET SET D4236/4248 WITHOUT OIL SEAL	1			
70912981		HEAD GASKET SET D4236/4248 WITH OIL SEAL	2			
70913031		BOTTOM GASKET SET T4236 WITHOUT OIL SEAL	3			
60913031		BOTTOM GASKET SET T4236 WITHOUT OIL SEAL	4			
N° ABR	N° ORIGINAL	DESCRIPTION				
RE02590F		VALVE STEM SEAL	8	8		
50050567	70730023	GASKET		2	2	
50911498	70490402	ACTUATOR TACHIMETRE GASKET	1	1	1	1
50913298	70490377	ACTUATOR TACHIMETRE GASKET	1	1	1	1
50916098	70490063	INJECTOR PUMP GASKET	1	1	1	1
50917996	70490800	REAR INTAKE MANIFOLD GASKET			1	1
50918398	70490379	REAR COVER CYLINDER GASKET	1	1	1	1
50918655	70490149	VALVE COVER GASKET	1	1	1	1
50918798	70490368	REAR COVER GASKET	1	1	1	1
50920898	36866722	OIL PUMP GASKET			1	1
50923498	70490385	BOX DISTRIBUTION GASKET	1	1	1	1
50924412	70490414	EXHAUST MANIFOLD GASKET	1	1	1	1
50924890	70490134	INSPECTION COVER GASKET	1	1	1	1
50925390	70490312	OIL PAN GASKET	1	1	1	1
50925590	36817136	BLOCK COVER GASKET			1	1
50925698	70490378	ACTUATOR TACHIMETER GASKET	1	1	1	1
50925790	70490408	THERMOSTATIC GASKET				1
50925890	70490796	FRONT INTAKE MANIFOLD GASKET			1	1
50925990	70490799	INTAKE MANIFOLD GASKET			1	1
50926016	36862134	INTAKE EXHAUST MANIFOLD GASKET			2	2
50926198	70490380	WATER CONNECTION GASKET	1	1	1	1
50926298	70926298	NOZZLE COVER GASKET	1	1	1	1
50926498	70490383	OIL FILTER GASKET	1	1	1	1
50926598	70490341	WATER PUMP GASKET	1	1	1	1
50926698	70490316	FUEL PUMP GASKET	1	1	1	1
50930198	70490267	THERMOSTAT GASKET	1	1	1	1
50931757	36825107	GASKET			1	1
50931998	70490412	WATER PUMP GASKET	1	1	1	1
50932090	70490100	INJECTOR PUMP GASKET				
50932598	70490386	REAR COVER GASKET				
50934198	70490347	OUTLET EXHAUST GASKET	1	1	1	1
50934616	70490373	OUTLET EXHAUST MANIFOLD GASKET			2	2
50936998	70490365	TIMING CASE COVER GASKE				
50937398	70490145	INJECTION PUMP GASKET				
50942095	70490746	INJECTOR PUMP GASKET				
50942198	36856102	FUEL PUMP GASKET	1	1	1	1
50942270	70490267	ADAPTER INTAKE MANIFOLD GASKET				
50944430	3688C003	FRONT INTAKE MANIFOLD GASKET	1	1		
50944630	3688C002	INTAKE MANIFOLD GASKET	1	1		
50944730	3688C001	REAR INTAKE MANIFOLD GASKET	1	1		
50945032	36885008	ENGINE BLOCK GASKET	1	1		
50946494	3687M006	INTAKE MANIFOLD GASKET	1	1		
50950098	70490398	OUTLET WATER CONNECTION GASKET	1	1		
50950398	70490345	OUTLET WATER CONNECTION GASKET	1	1	1	1
50950890	70490314	TURBOCHARGING GASKET	1	1		
50951490	70490376	INTAKE EXHAUST GASKET	1	1		
50951630	3688C007	INTAKE EXHAUST MANIFOLD GASKET	2	2		
50952790	70490317	TURBOCHARGING GASKET	1	1		
50954298	70490329	OIL FILTER GASKET	1	1	1	1
50955198	70490334	WATER CONNECTION PUMP GASKET	1	1		
50965504	70490304	CYLINDER HEAD GASKET	1	1	1	1
80977940		KIT WASHER RUBBER	1	1	1	1
RE01050S		PULLEY OIL SEAL	1	1		
RE01972S		REAR OIL SEAL	1	1		

• SOLD SEPARATELY

4236/4248

APPLICATION



PERKINS P4203 INDIRECT INJECTION 4 CYL 3.3L

FORD TRACTOR 8BR 1961/67

PERKINS P4203 INDIRECT INJECTION 4 CYL 3.3L

MASSEY FERGUSON TRACTOR MF 65 1965/82 CBT TRACTOR 1000 1975/...CASE TRACTOR 580E 1972/85

4236/4248

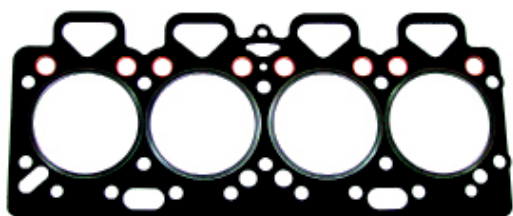

50965504



50918655



50924890

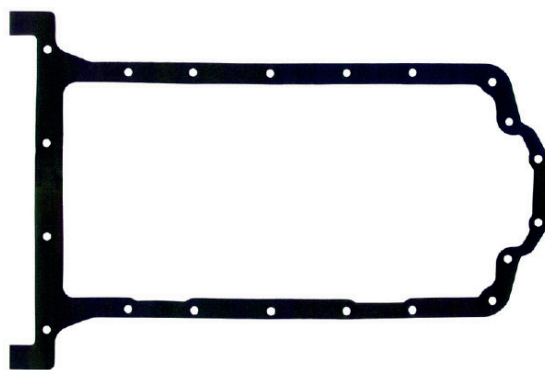

50925390

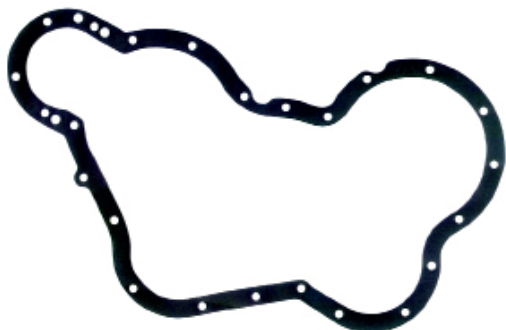

50936998

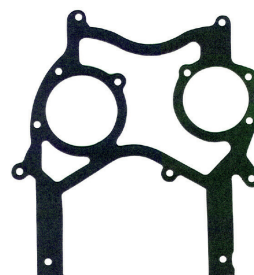

50918798



50955198



50931998



50920898



50925790



5091839



50945032



50944630



50925990



50911498

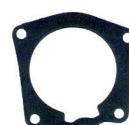

50942270

4236/4248



50932598



50937398



5094694

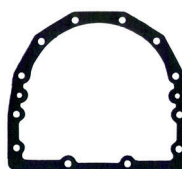

50934198



50925590



50930198



50942095



50926698



50932090



50916098



50925698



50950098



58311632



58317447



58317447



50952790



58318467



58311632



58317447



58317447



50917996



50944730



50944430



50925890



50934616



50951630



50926016



50942108



50922698



50926498



50926198



50926598



50931757



59331757



50923498



RE01972S



RE01050S



50924412



50050567



RE02590F

80903426		KIT RUBBER	
Nº ABR	Nº ORI	DESCRIPTION	QTD
50937620	70920081	INJECTOR NOZZLE WASHER 10,0X19,2X2,0 MM	4
50962240	70730019	INJECTION PORT SEAL	4
50972641	32811408	SEAL	2
50963941	33811113	FUEL LINE SEAL	1

N° SET		DESCRIPTION			
60916151		FULL GASKET SET 4236/4248 WITHOUT OIL SEAL	1		
70916151		HEAD GASKET SET 4236/4248 WITH OIL SEAL	2		
70933031		BOTTOM GASKET SET 4236/4248 WITH OIL SEAL	3		
70930051		BOTTOM GASKET SET 4236/4248 WITH OIL SEAL	4		
N° ABR	N° ORIGINAL	DESCRIPTION			
RE02590F		VALVE STEM SEAL	8	8	8
50050567	70730023	GASKET			
50911498	70490402	ACTUATOR TACHIMETRE GASKET			1 1
50913298	70490377	ACTUATOR TACHIMETRE GASKET			1 1
50916098	70490063	INJECTO PUMP GASKET			1 1
50917996	70490800	REAR INTAKE MANIFOLD GASKET	1		1 1
50918398	70490379	REAR COVER CYLINDER GASKET	1	1	1 1
50918655	70490149	VALVE COVER GASKET	1	1	1 1
50918798	70490368	REAR TIMING COVER GASKET			1 1
50920898	36866722	OIL PUMP GASKET			1 1
50923498	70490385	BOX DISTRIBUTION GASKET			1 1
50924412	70490414	EXHAUST GASKET	1	1	1 1
50924890	70490134	TIMING COVER GASKET			
50925390	70490312	OIL PAN GASKET			1 1
50925590	36817136	BLOCK COVER GASKET			1 1
50925698	70490378	ACTUATOR TACHIMETER GASKET			1 1
50925790	70490408	THERMOSTATIC GASKET	1		1 1
50925890	70490796	FRONT EXHAUST MANIFOLD GASKET	1		1 1
50925990	70490799	EXHAUST MANIFOLD GASKET	1		1 1
50926016	36862134	EXHAUST MANIFOLD GASKET	2		2 2
50926198	70490380	WATER CONECTION GASKET	1		1 1
50926298	70926298	COVER NOZZLE GASKET			1 1
50926498	70490383	OIL FILTER GASKET			1 1
50926598	70490341	WATER PUMP GASKET		1	1 1
50926698	70490316	FUEL PUMP GASKET			1 1
50930198	70490267	THERMOSTATIC GASKET	1		1 1
50931757	36825107	GASKET			1 1
50931998	70490412	WATER PUMP GASKET			1 1
50932090	70490100	INJECTOR PUMP GASKET			1 1
50932598	70490386	REAR COVER GASKET			1 1
50934198	70490347	OUTLET EXHAUST GASKET			1 1
50934616	70490373	OUTLET EXHAUST GASKET			1 1
50936998	70490365	TIMING COVER GASKET	2		2 2
50937398	70490145	INJECTION PUMP GASKET			1 1
50942095	70490746	INJECTOR PUMP GASKET			1 1
50942198	36856102	FUEL PUMP GASKET			1 1
50942270	70490267	INTAKE MANIFOLD GASKET			1 1
50944430	3688C003	FRONT EXHAUST MANIFOLD GASKET			1 1
50944630	3688C002	EXHAUST MANIFOLD GASKET		1	
50944730	3688C001	REAR INTAKE MANIFOLD GASKET		1	
50945032	36885008	ENGINE BLOCK GASKET		1	
50946494	3687M006	BLOCK COVER GASKET		1	
50950098	70490398	OUTLET WATER CONECTION GASKET			
50950398	70490345	OUTLET WATER CONECTION GASKET			
50950890	70490314	TURBOCHARGING GASKET	1	1	1 1
50951490	70490376	INTAKE EXHAUST		1	
50951630	3688C007	EXHAUST MANIFOLD GASKET			
50952790	70490317	TURBOCHARGING GASKET		2	
50954298	70490329	OIL FILTER GASKET		1	
50955198	70490334	WATER CONECTION PUMP GASKET			1 1
50965504	70490304	CYLINDER HEAD GASKET			
80977940		KIT WASHERS AND RUBBERS	1	1	1 1
RE01050S		PULLEY OIL SEAL	1	1	1 1
RE01972S		REAR OIL SEAL		1	

• SOLD SEPARATELY

4236/4248

APPLICATION



PERKINS P4203 INDIRECT INJECTION 4 CYL 3.3L

FORD TRACTOR 8BR 1961/67

PERKINS P4203 INDIRECT INJECTION 4 CYL 3.3L

MASSEY FERGUSON TRACTOR MF 65 1965/82 CBT TRACTOR 1000 1975/...CASE TRACTOR 580E 1972/85

4236/4248

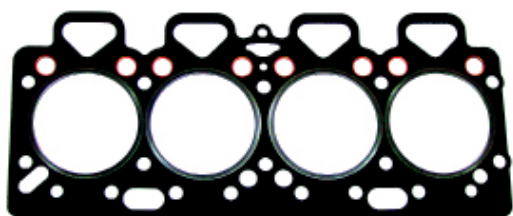

50965504



50918655



50924890

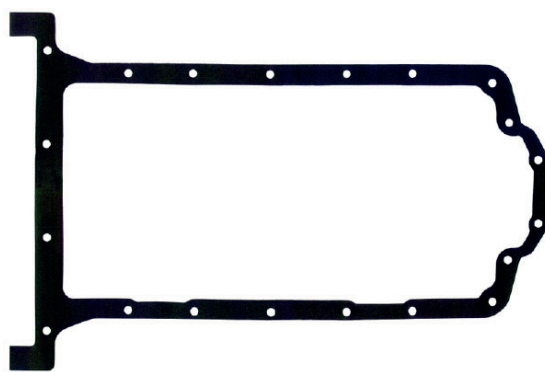

50925390

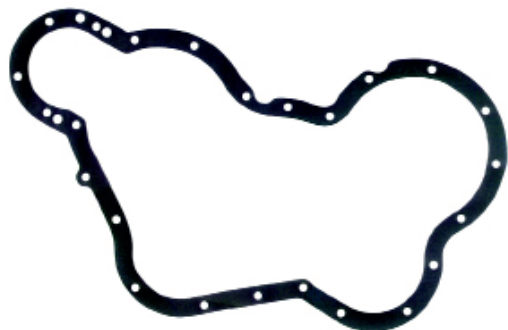

50936998

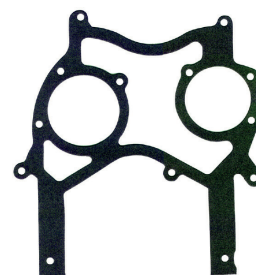

50918798



50955198



50931998



50920898



50925790



5091839



50945032



50944630



50925990

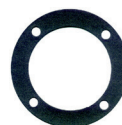

50911498



50942270

4236/4248



50932598



50937398



5094694

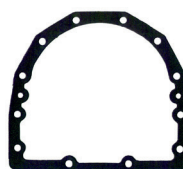

50934198



50925590



50930198



50942095



50926698



50932090



50916098



50925698



50950098



58311632



58317447



58317447



50952790



58318467



58311632



58317447



58317447



50917996



50944730



50944430



50925890



50934616



50951630



50926016



50942108



50922698



50926498



50926198



50926598



50931757



59331757



50923498



RE01972S



RE01050S



50924412



50050567



RE02590F

80903426		KIT RUBBER	
Nº ABR	Nº ORIGINAL	DESCRIPTION	QTD
50937620	70920081	INJECTOR NOZZLE WASHER 10,0X19,2X2,0 MM	4
50962240	70730019	INJECTION PORT SEAL	4
50972641	32811408	SEAL	2
50963941	33811113	FUEL LINE SEAL	1

N° SET		DESCRIPTION				
60910151		FULL GASKET SET 4236/Q20B WITHOUT OIL SEAL				1
70910151		HEAD GASKET SET 4236/Q20B WITHOUT OIL SEAL				2
60930051		BOTTOM GASKET SET 4236/Q20B WITHOUT OIL SEAL				3
70930051		BOTTOM GASKET SET 4236/Q20B WITHOUT OIL SEAL				4
N° ABR	N° ORIGINAL	DESCRIPTION				
RE02590F		VALVE STEM SEAL	8			8
50917996	70490800	REAR INTAKE MANIFOLD GASKET	1	1	1	1
50918398	70490379	REAR COVER CYLINDER GASKET	1	1	1	1
50918655	70490149	VALVE COVER GASKET	1	1	1	1
50918798	70490368	REAR COVER GASKET				1 1
50922198	70490352	GASKET				1 1
50922398	70490370	OIL PAN GASKET				1 1
50922498	70490375	OIL FILTER GASKET				1 1
50922698	70490409	BLOCK COVER GASKET				1 1
50923398	70490407	INSPECTION COVER GASKET				1 1
50923498	70490385	BOX DISTRIBUTION GASKET				1 1
50924412	70490414	GASKET DO ESCAPAMENTO	1	1	1	1
50925698	70490378	ACTUATOR TACHIMETRE GASKET				1 1
50925790	70490408	THERMOSTATIC GASKET	1	1	1	1
50925890	70490796	FRONT INTAKE MANIFOLD GASKET	1	1	1	1
50925990	70490799	INTAKE MANIFOLD GASKET CENTRAL	1	1	1	1
50926016	70490319	INTAKE EXHAUST MANIFOLD GASKET	2	2	2	2
50926198	70490380	OUTLET WATER CONNECTION GASKET	1	1	1	1
50926498	70490383	OIL FILTER GASKET				1 1
50926698	70490316	FUEL PUMP GASKET				1 1
50930198	70490746	THERMOSTATIC COVER GASKET	1	1	1	1
50931757	36825107	GASKET				1 1
50931998	70490412	WATER PUMP GASKET				1 1
50932090	70490100	INJECTOR PUMP GASKET				1 1
50932598	70490328	RELIEF COVER GASKET				1 1
50934198	70490347	REAR COVER GASKET				1 1
50934616	70490373	OUTLET EXHAUST MANIFOLD GASKET	2	2	2	2
50936898	70490328	INJECTION PUMP GASKET				1 1
50937398	70490145	EXHAUST ADAPTER GASKET				1 1
50942095	70490315	INJECTOR PUMP GASKET				1 1
50942198	36856102	FUEL PUMP GASKET				1 1
50942270	70490267	ADAPTER INTAKE MANIFOLD GASKET				1 1
50949698	70490339	WATER PUMP GASKET				1 1
50949753	70490178	OIL PAN GASKET				1 1
50950098	70490398	OUTLET WATER CONNECTION GASKET	1	1	1	1
50950398	70490345	OUTLET WATER CONNECTION GASKET	1	1	1	1
50965504	70490304	CYLINDER HEAD GASKET	1	1	1	1
80977940		KIT WASHERS AND RUBBERS				1 1
80979326		KIT WASHERS AND RUBBERS				1
RE01050S		PULLEY OIL SEAL				1
RE01972S		REAR OIL SEAL				1

• SOLD SEPARATELY

4236/Q20B

APPLICATION



PERKINS P4203 INDIRECT INJECTION 4 CYL 3.3L

FORD TRACTOR 8BR 1961/67

PERKINS P4203 INDIRECT INJECTION 4 CYL 3.3L

MASSEY FERGUSON TRACTOR MF 65 1965/82 CBT TRACTOR 1000 1975/...CASE TRACTOR 580E 1972/85

4236/Q20B

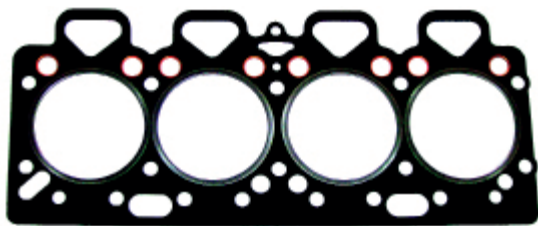

50965504

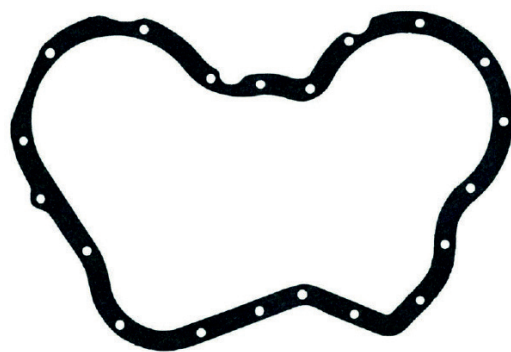

50918655

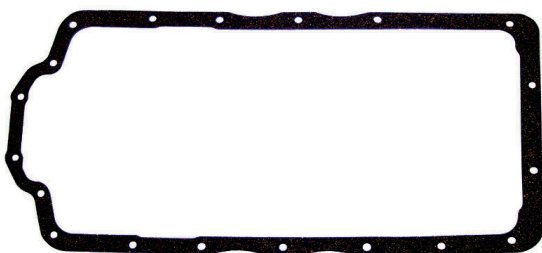

50965504



50918655

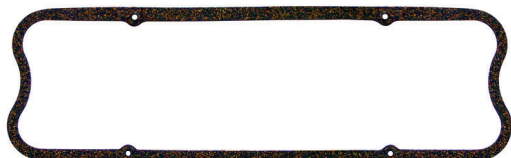

50915290

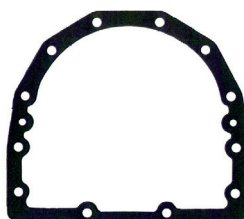

50923990

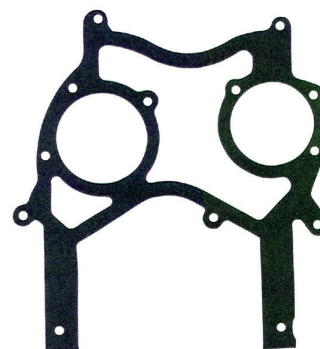

50914490

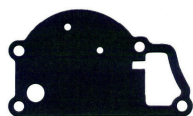

50923816

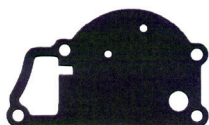

50910590



50916098



50914396



50923816



50910590



50916098



50914396

4236/Q20B



50923816



50910590



50916098



50914396



50923816



50910590



50916098



50914396



50923816



50910590



50916098



50914396



50923816



50910590



50916098



50914396



50923816



50910590



50916098



50914396



50923816



50910590



50916098



50914396



50923816

80979326 KIT RUBBER		
N° ABR	DESCRIPTION	QTD
50028725	ALUMINIUM WASHER 8,0X12,0X1,0 MM	1
50026929	ALUMINIUM WASHER 14,0X18,0X1,5 MM	1
50023329	ALUMINIUM WASHER 16,0X22,0X1,5 MM	4
50020025	ALUMINIUM WASHER 16,0X20,0X1,5 MM	7
50015529	ALUMINIUM WASHER 10,0X16,0X1,5 MM	14
50012929	ALUMINIUM WASHER 22,0X27,0X2,0 MM	8
50009923	COPPER WASHER 7,2X15,2X2,0 MM	8

80977940 KIT RUBBER			
N° ABR	N° ORI	DESCRIPTION	QTD
50937620	70920081	WASHER BICO INJETORA 10,0X19,2X2,0 MM	4
50962240	70730019	INJECTION PORT SEAL	4
50972641	32811408	SEAL DA PLACA INTERMEDIARIA	2
50963941	33811113	FUEL LINE SEAL	1

N° SET		DESCRIPTION						
60914763		FULL GASKET SET WITHOUT OIL SEAL	1					
70914763		FULL GASKET SET WITHOUT OIL SEAL	2					
60934763		HEAD GASKET SET WITHOUT OIL SEAL	3					
60914053		FULL GASKET SET WITHOUT OIL SEAL	4					
70914053		FULL GASKET SET WITHOUT OIL SEAL	5					
60934053		HEAD GASKET SET WITHOUT OIL SEAL	6					
N° ABR	N° ORIGINAL	DESCRIPTION						
50925390	368174007	OIL PAN GASKET	1	1				
50932831	736882191	INTAKE EXHAUST MANIFOLD GASKET	2	2	2	2	2	2
50937620	70920081	WASHER	4	4	4	6	6	6
50938030	70490160	INTAKE MANIFOLD GASKET CENTRAL	2	2	2	2	2	2
50939300	3681E037	CYLINDER HEAD GASKET	1	1	1			
50942941		VALVE STEM SEAL	8	8	8	12	12	12
50944532	36866746	INTAKE EXHAUST MANIFOLD GASKET	1	1	1	1	1	1
50945032	36885008	TURBOCHARGING GASKET	1	1	1	1	1	1
50945431	70490161	INTAKE MANIFOLD GASKET	2	2	2	2	2	2
50947090	3681P009	BOX DISTRIBUTION GASKET		1	1		1	1
50948067	3681P011	INSPECTION COVER GASKET		1	1		1	1
50949540	70490258	VALVE COVER GASKET	1	1	1			
50967840	70920081	INJECTOR PUMP GASKET	4	4	4	6	6	6
50970150	3681C001	VALVE COVER GASKET				1	1	1
50970290	3382P004	WATER PUMP GASKET		1	1		1	1
50971190	3681H007	OIL PAN GASKET					1	1
50971400	3681H218	CYLINDER HEAD GASKET				1	1	1
50981967	3685N008	EXHAUST TUBE GASKET	1	1	1	1	1	1
50982067	3685R005	THERMOSTATIC GASKET	1	1	1	1	1	1
50982167	3685F006	THERMOSTATIC COVER GASKET	1	1	1	1	1	1
50982267	3683H006	TURBOCHARGING GASKET	1	1	1	1	1	1
50982367	36832135	INLET OIL PUMP GASKET	1	1	1	1	1	1
50982467	36832131	OUTLET OIL PUMP GASKET	1	1	1	1	1	1
50982567	3686A004	THERMOSTATIC GASKET	1	1	1	1	1	1
50982667	3684R004	OIL FILTER GASKET		1	1		1	1
50982767	3687W003	OIL FILTER GASKET		1	1		1	1
50982867	3687Y002	OIL FILTER GASKET		1	1		1	1
50982967		POWER SUPPLY GASKET		1	1		1	1
50983067	3687H005	COVER SEAL GASKET		1	1		1	1
50983167	36817181	INSPECTION COVER GASKET		1	1		1	1
50983267	3682H003	OIL FILTER GASKET		1	1		1	1
50983367	368A511	FUEL PUMP GASKET		1	1		1	1
50983467	33828108	INJECTOR PUMP GASKET		1	1		1	1
50983567	3686T004/006	OIL FILTER GASKET		1	1		1	1
50983667		TUBE GASKET		1	1		1	1
50983767	36811115	OIL FILTER BREATHER GASKET		1	1		1	1
50983867		THERMOSTATIC GASKET		1	1		1	1
50983967	3683N004	THERMOSTATIC COVER GASKET		1	1		1	1
50984067		THERMOSTATIC GASKET		1	1		1	1
50984167	36832143	OIL PUMP GASKET		1	1		1	1
RE01050S		PULLEY OIL SEAL		1			1	
RE01972S		REAR OIL SEAL		1			1	

● SOLD SEPARATELY

1004/10044T/1006/10066T

APPLICATION



PERKINS P4203 INDIRECT INJECTION 4 CYL 3.3L

FORD TRACTOR 8BR 1961/67

PERKINS P4203 INDIRECT INJECTION 4 CYL 3.3L

MASSEY FERGUSON TRACTOR MF 65 1965/82 CBT TRACTOR 1000 1975/...CASE TRACTOR 580E 1972/85

1004/10044T/1006/10066T



50939300

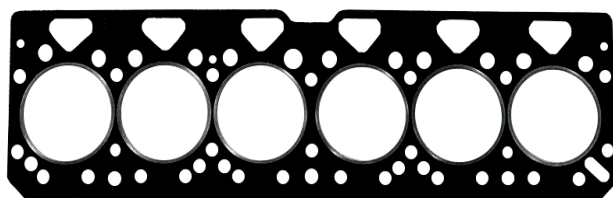

50971400



50949540



50970150

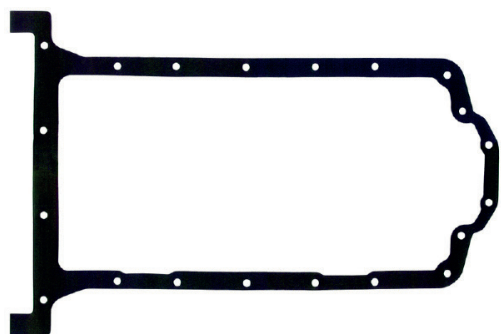

50925390*

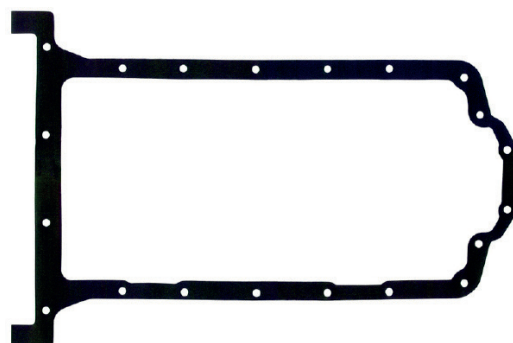

50925390

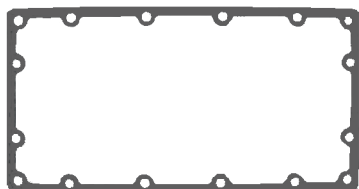

50982667

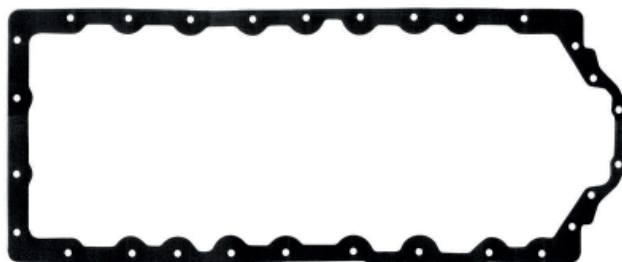

50971190

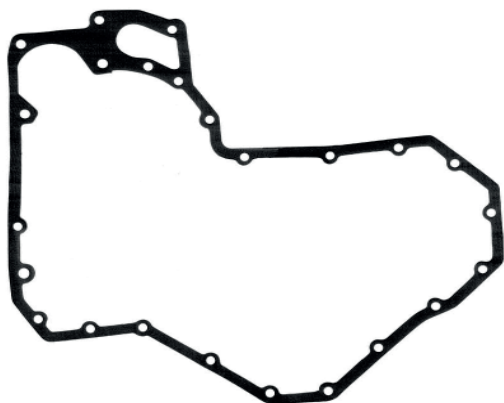

50948067

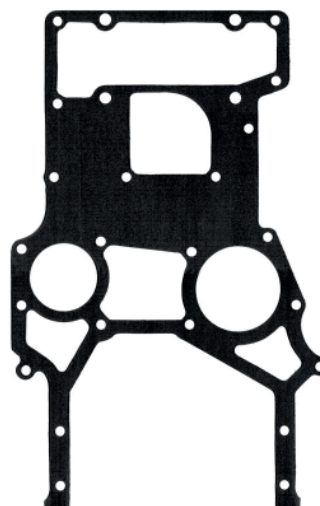

50947090

1004/10044T/1006/10066T



50982967

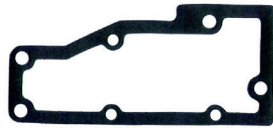

50982167

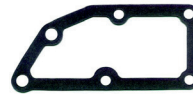

50982167

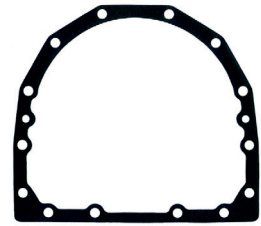

50983067

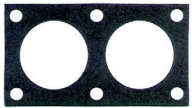

50982567



50945032

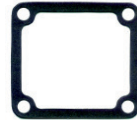

50981967

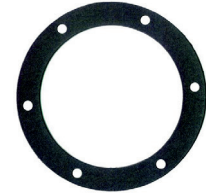

50914396



50983267



50944532



50938030



50983167



50983267



50983367



50982867



50982767



50932831



50945431



50983967



50982367



50983867



50910590



50982467



50982467



50982367



50984167



50916098



50914396



50967840



50937620



50942941

N° SET	DESCRIPTION	
60914753	FULL GASKET SET WITHOUT OIL SEAL	1
70914753	FULL GASKET SET WITH OIL SEAL	2
70934751	HEAD GASKET SET WITH OIL SEAL	3

N° ABR	N° ORIGINAL	DESCRIPTION		
RE02590F		VALVE STEM SEAL	2	2
50913298	70490377	INTAKE EXHAUST GASKET	1	1
50917996	70490800	INTAKE MANIFOLD GASKET	1	1
50924890	70490311	INSPECTION COVER GASKET	2	2
50925390	3681H007	OIL PAN GASKET	1	1
50925698	70490378	GASKET	1	1
50925790	70490408	THERMOSTATIC COVER GASKET	1	1
50925890	70490796	FRONT INTAKE MANIFOLD GASKET	1	1
50925990	70490799	INTAKE MANIFOLD GASKET CENTRAL	1	
50926198	70460380	OUTLET WATER BRETHHER CURVE GASKET	1	1
50926298	70490320	FUEL PUMP NOZZLE GASKET	1	1
50926498	70490383	OIL FILTER GASKET	1	1
50926598	70490341	WATER PUMP GASKET	1	1
50931757	36825107	ACTUATOR TACHIMETER GASKET	2	2
50931996	70490412	WATER PUMP GASKET	1	1
50934198	70490347	REAR COVER GASKET	1	1
50936898	70490328	INJECTOR PUMP GASKET	1	1
50942198	36856102	FUEL PUMP GASKET	1	1
50945032	36885008	TURBOCHAGING GASKET	1	1
50946494	3687M006	ENGINE BLOCK GASKET	1	1
50948890	70490713	INLET OIL PUMP GASKET	1	1
50949090	70490369	BOX DISTRIBUTION GASKET	1	1
50949540	70490258	VALVE COVER GASKET	1	1
50950398	70490345	THERMOSTATIC VALVE GASKET	1	1
50950890	70490314	OUTLET TURBOCHARGING GASKET	1	1
50951490	70490376	FUEL PUMP TUBE GASKET	1	
50951630	3688C007	INTAKE EXHAUST MANIFOLD GASKET	1	1
50953304	70490415	CYLINDER HEAD GASKET	1	1
50954298	70490375	OIL TUBE SUCTION GASKET	1	1
50955198	70490334	WATER CONECTION PUMP GASKET		
50971017	70490283	TURBOCHARGING COVER GASKET		
50918398	70490379	REAR CYLINDER COVER GASKET		
60014756		KIT WASHER RUBBER		
RE01050S		PULLEY OIL SEAL		
RE01972S		REAR OIL SEAL		

● SOLD SEPARATELY

P4000/P4000T

APPLICATION



PERKINS P4203 INDIRECT INJECTION 4 CYL 3.3L

FORD TRACTOR 8BR 1961/67

PERKINS P4203 INDIRECT INJECTION 4 CYL 3.3L

MASSEY FERGUSON TRACTOR MF 65 1965/82 CBT TRACTOR 1000 1975/...CASE TRACTOR 580E 1972/85

P4000/P4000T

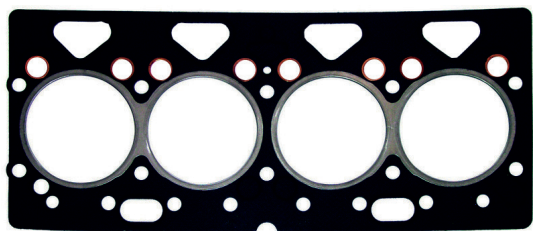

50953304



50949540

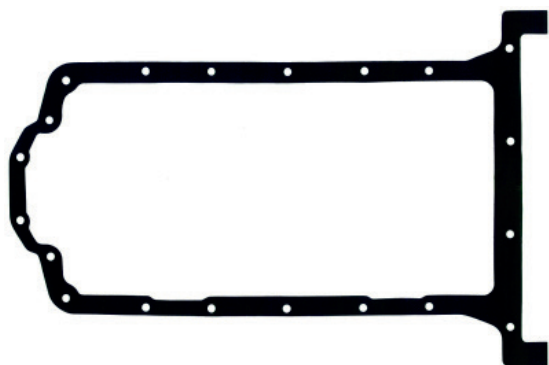

50925990



50924890

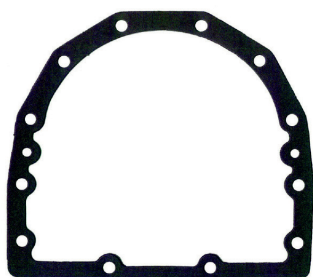

50934198



50949090



50946494



50918398



50925790

P4000/P4000T



50951630



50926298



50925990



50945032



50955198



50931996



50951490



50948890



50950890



50913298



50954298



50925698



50917996





50926198



50926498



50936898



50942198



50950398



50926598



50931757



50971017



RE01972S



RE01050S



RE02590F

60014756		KIT RUBBER
N° ABR	DESCRIPTION	QTD
50012325	ALUMINIUM WASHER 8,0X12,0X1,0 MM	4
50016529	COPPER WASHER 14,0X18,0X1,5 MM	5
50937620	COPPER WASHER 16,0X22,0X1,5 MM	2
50010123	COPPER WASHER 16,0X20,0X1,5 MM	9
50917220	COPPER WASHER 10,0X16,0X1,5 MM	4
50963941	FUEL LINE SEAL	1

N° SET	DESCRIPTION	
60914733	FULL GASKET SET S4/S4T WITHOUT OIL SEAL	1
70914733	FULL GASKET SET S4/S4T WITHOUT OIL SEAL	2
70934731	HEAD GASKET SET S4/S4T WITHOUT OIL SEAL	3

N° ABR	N° ORIGINAL	DESCRIPTION			
RE02590F		VALVE STEM SEAL	8	8	
50918398	70490379	REAR CYLINDER COVER GASKET	1	1	1
50923498	70490385	VACCUM PUMP GASKET		1	1
50925790	70490408	THERMOSTATIC COVER GASKET	1	1	1
50934198	70490347	REAR COVER GASKET		1	1
50936898	70490328	INJECTOR PUMP GASKET		1	1
50942095	70490315	INJECTOR PUMP GASKET		1	1
50942198	36856102	INTAKE MANIFOLD CURVE GASKET		1	1
50943298	70490257	OIL FILTER GASKET	1	1	1
50943398	70490335	BETWEEN MANIFOLD GASKET		1	1
50943598	70490413	FRONT INTAKE MANIFOLD GASKET		1	1
50944430	3688C003	INTAKE MANIFOLD GASKET	1	1	1
50944630	3688C002	REAR INTAKE MANIFOLD GASKET	1	1	1
50944730	3688C001	TURBOCHAGING GASKET	1	1	1
50945032	36885008	THERMOSTATIC GASKET	1	1	1
50946398	70490337	INLET OIL PUMP GASKET	1	1	1
50948890	70490713	WATER PUMP GASKET	1	1	1
50948998	70490336	BOX DISTRIBUTION GASKET		1	1
50949090	7049090*	VALVE COVER GASKET		1	1
50949540	70490358	WATER PUMP GASKET	1	1	1
50949698	70490339	OIL PAN GASKET		1	1
50949753	70490178	INTAKE MANIFOLD GASKET		1	1
50950098	70490398	OUTLET OIL CRACKSHAFT GASKET		1	1
50950890	70490314	INTAKE EXHAUST MANIFOLD GASKET	1	1	1
50951630	3688C007	CYLINDER HEAD GASKET	2	2	2
50951832	3688A009	KIT RUBBERS	1	1	1
50953304	70490415	KIT WASHERS	1	1	1
80964541		PULLEY OIL SEAL	1	1	1
80978020		REAR OIL SEAL		1	1
RE01050S		FRONT CRANKSHAFT OIL SEAL		1	
RE01972S		REAR CRANKSHAFT OIL SEAL		1	

● SOLD SEPARATELY

S4/S4T

APPLICATION



PERKINS P4203 INDIRECT INJECTION 4 CYL 3.3L

FORD TRACTOR 8BR 1961/67

PERKINS P4203 INDIRECT INJECTION 4 CYL 3.3L

MASSEY FERGUSON TRACTOR MF 65 1965/82 CBT TRACTOR 1000 1975/...CASE TRACTOR 580E 1972/85

S4/S4T

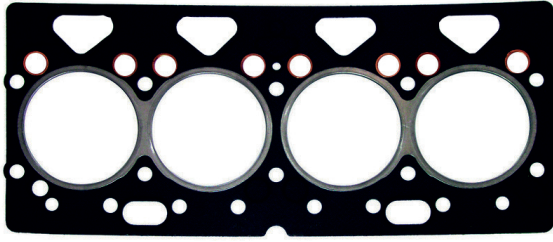

50953304



50949540

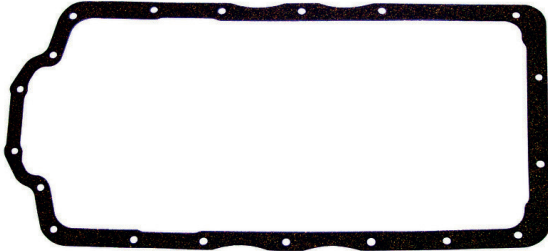

50949753

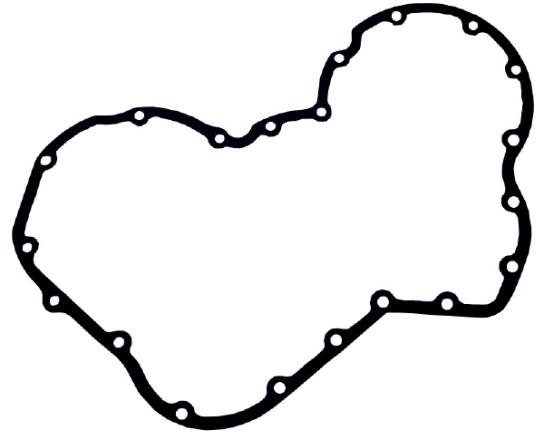

50943598

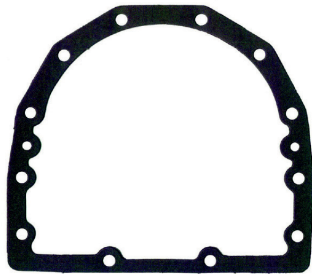

50934198

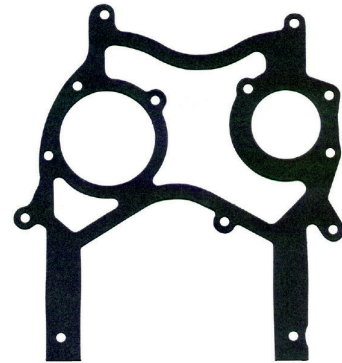

50949090

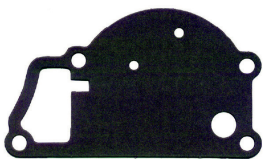

50949698



50948998



50923498



50945032

S4/S4T



50951630



50944630



50944730



50944430



50950890



50948890



50950098



50942095

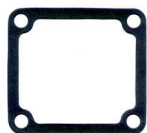

50943298



50918398



50925790



50943398

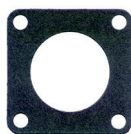

50946398



50936898

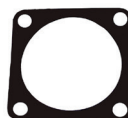

50951832



50942198



RE01972S



RE01050S



RE02590F

80964541		KIT RUBBER	
Nº ABR	Nº ORI	DESCRIPTION	QTD
50964141	70590007	ANEL BORRACHA DO CÁRTER	2
50964041	33817132	INJECTION PORT SEAL	4
50964241	70590008	INJECTOR NOZZLE SEAL	4
50963941	33811113	FUEL LINE SEAL	1
50964341	70590009	BOX DISTRIBUTION SEAL	1
50964441	70590011	CYLINDER COVER SEAL	1

80978020		KIT RUBBER	
Nº ABR	DESCRIPTION	QTD	
5009923	COPPER WASHER 6,2X10,2X1,0 MM	6	
50011228	ALUMINIUM WASHER 8,0X12,0X1,0 MM	2	
	COPPER WASHER 8,0X12,0X2,0 MM	4	
50021129	ALUMINIUM WASHER 14,0X18,0X1,5 MM	8	
50023329	ALUMINIUM WASHER 16,0X22,0X1,5 MM	3	
50023629	ALUMINIUM WASHER 16,0X22,0X1,5 MM	4	
50015529	ALUMINIUM WASHER 10,0X16,0X1,5 MM	4	
50028725	ALUMINIUM WASHER 22,0X27,0X2,5 MM	2	
50011024	COPPER WASHER 10,0X15,2X2,0 MM	4	

N° SET		DESCRIPTION		
60914773		FULL GASKET SET HS 2.5 WITHOUT OIL SEAL		1
70914773		FULL GASKET SET HS 2.5 WITHOUT OIL SEAL		2
60934773		HEAD GASKET SET HS 2.5 WITHOUT OIL SEAL		3
70934773		HEAD GASKET SET HS 2.5 WITHOUT OIL SEAL		4
N° ABR	N° ORIGINAL	DESCRIPTION		
RE02396F		VALVE STEM SEAL	8	8
RE05239F		REAR OIL SEAL		1
509100650		REAR MANCAL GASKET		2 2
50946877	ERR4861	REAR COVER GASKET		1 1
50947267	ERR1653	DRAIN OIL GASKET		1 1
50947367	ERR1278	WATER PUMP BLOCK GASKET		1 1
50947467	ERR2018	FUEL PUMP GASKET		1 1
50947567	ERR4860	FRONT COVER BLOCK GASKET		1 1
50947667	ERR2027	VACCUM PUMP GASKET		1 1
50947767	ERR2023	INJECTOR PUMP GASKET		1 1
50947867	ERR1516	INSPECTION COVER GASKET		1 1
50947967	ERR3284	WATER PUMP GASKET		1 1
50948167	ERR2026	CYLINDER FILTER GASKET		1 1
50948267	ERR3490	THERMOSTATIC GASKET	1 1	1 1
50948367	ERR3283	OIL FILTER GASKET		1 1
50948467	ERR4120	BOX DISTRIBUTION GASKET		1 1
50948567		OIL RADIATOR GASKET		1 1
50962400	ERR5260	CYLINDER HEAD GASKET		
50963644	70490309	VALVE COVER GASKET	1 1	1 1
50965300	70490307	CYLINDER HEAD GASKET	1 1	1 1
50977147	70490308	INTAKE MANIFOLD GASKET	1 1	1 1
80964650	70490300	OIL PAN GASKET		1 1
80966826		KIT WASHERS		1 1
80967226		HEAD KIT WASHERS	1 1	
RE05352S		FRONT OIL SEAL		1
RE05353S		CAMSHAT SEAL		1
RE05413N		TIMING OIL SEAL		1

● SOLD SEPARATELY

HS 2.5

APPLICATION



FORD RANGER TD 1995/...

FORD RANGER TD 2.8 2002/...

CHEVROLET S10 TDI/BLAZER TDI 1995/...

LAND ROVER DEFENDER 90/110/130/RANGE ROVER/DISCOVERY TDI 1994/98

MERCEDES SPRINTER TDI 1997/...

FORD RANGER TD 2.8 2002/...

HS 2.5



50977147



50963644



RE05239F

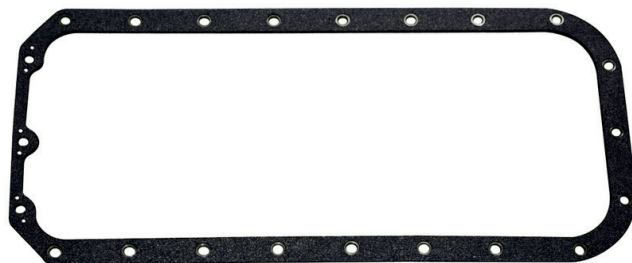

50918655



50947567



50948467



50947367



50947967



50947767



50946877

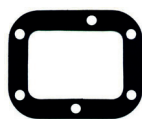

50948167



50947667



50948267



50948367

HS 2.5



50947267



50947467



50947867



509100650



50948567



RE05353S



RE05352S



RE05353S



RE02396F

80966826		KIT RUBBER	
N° ABR	DESCRIPTION	QTD	
50092529	ALUMINIUM WASHER 12,0X18,0X1,5 MM	4	
50009923	COPPER WASHER 6,4X10,0X1,0 MM	1	
50011020	WASHER DE CU 7,3X15,2X1,0 MM	4	
50011024	WASHER DE CU 7,3X15,2X2,0 MM	4	
50070329	WASHER DE AL 18,5X22,0X1,5 MM	7	
50011228	WASHER DE AL 8,0X12,0X1,0 MM	2	
50022229	WASHER DE AL 14,6X20,8X1,5 MM	6	
50021529	WASHER DE AL 14,0X20,0X1,5 MM	5	
50026729	WASHER DE AL 20,0X26,0X1,5 MM	8	

80967226		KIT RUBBER	
N° ABR	DESCRIPTION	QTD	
50011020	COPPER WASHER 7,3X15,2X1,0 MM	4	
50011024	COPPER WASHER 7,3X15,2X2,0 MM	4	

N° SET		DESCRIPTION		
60914873		FULL GASKET SET HS 2.8 WITHOUT OIL SEAL		1
70914873		FULL GASKET SET HS 2.8 WITHOUT OIL SEAL		2
60934873		HEAD GASKET SET HS 2.8 WITHOUT OIL SEAL		3
70934873		HEAD GASKET SET HS 2.8 WITHOUT OIL SEAL		4
N° ABR	N° ORIGINAL	DESCRIPTION		
RE02396F		VALVE STEM SEAL	8	8
RE05239F		REAR OIL SEAL		1
509100650		REAR MANCAL GASKET		2 2
50946877	ERR4861	REAR COVER GASKET		1 1
50947267	ERR1653	DRAIN OIL GASKET		1 1
50947367	ERR1278	WATER PUMP GASKET		1 1
50947467	ERR2018	FUEL PUMP GASKET		1 1
50947567	ERR4860	FRONT COVER GASKET		1 1
50947667	ERR2027	VACCUM PUMP GASKET		1 1
50947767	ERR2023	INJECTOR PUMP GASKET		1 1
50947867	ERR1516	INSPECTION COVER GASKET		1 1
50947967	ERR3284	WATER PUMP GASKET		1 1
50948167	ERR2026	CYLINDER FILTER GASKET	1 1	1 1
50948267	ERR3490	THERMOSTATIC GASKET		1 1
50948367	ERR3283	OIL FILTER GASKET		1 1
50948467	ERR4120	BOX DISTRIBUTION GASKET		1 1
50948567		OIL RADIATOR GASKET		1 1
50962400	ERR5260	CYLINDER HEAD GASKET	1 1	1 1
50963644	70490309	VALVE COVER GASKET	1 1	1 1
50965300	70490307	CYLINDER HEAD GASKET		
50977147	70490308	INTAKE MANIFOLD GASKET	1 1	1 1
80964650	70490300	OIL PAN GASKET		1 1
80966826		KIT WASHERS		1 1
80967226		HEAD KIT WASHERS		
RE05352S		FRONT OIL SEAL		1
RE05353S		CAMSHAT SEAL		1
RE05413N		TIMING OIL SEAL		1

● SOLD SEPARATELY

HS 2.8

APPLICATION



PERKINS P6354/P6354.4 6 CYL.5.8L VEICULAR/AGRÍCOLA

CHRYSLER TRUCK DODGE D700/750/900 1970/81

MASSEY FERGUSON TRACTOR MF 296 1976/89

PERKINS P6354.4/Q20B 6 CYL.5.8L TURBO VEICULAR/AGRÍCOLA

CHEVROLET TRUCK DS12000/14000 1992/96

MASSEY FERGUSON TRACTOR MF 500B 1982/87

PERKINS P6354.4 6 CYL.5.8L TURBO

MASSEY FERGUSON TRACTOR MF 297 1989/92 MF 299 1989/9

HS 2.8



50977147



5093644



50965504

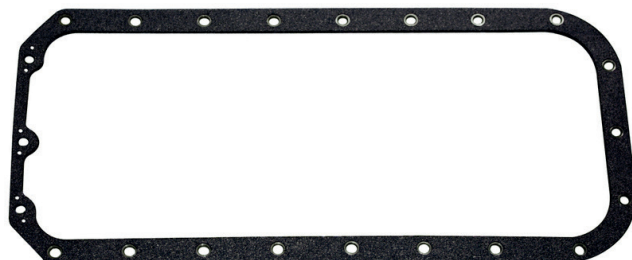

80964650



50947567



50948467



50947367



50947967



50947767



50946877

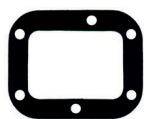

50948167



50947667



50948267



50948367

HS 2.8



50947267



50947467



50947867



509100650



50948567



RE05353S



RE05413N



RE05352S



RE02396F

80966826 KIT RUBBER		
N° ABR	DESCRIPTION	QTD
50092529	ALUMINIUM WASHER 12,0X18,0X1,5 MM	4
50009923	COPPER WASHER 6,4X10,0X1,0 MM	1
50011020	COPPER WASHER 7,3X15,2X1,0 MM	4
50011024	COPPER WASHER 7,3X15,2X2,0 MM	4
50070329	ALUMINIUM WASHER 18,5X22,0X1,5 MM	7
50011228	ALUMINIUM WASHER 8,0X12,0X1,0 MM	2
50022229	ALUMINIUM WASHER 14,6X20,8X1,5 MM	6
50021529	ALUMINIUM WASHER 14,0X20,0X1,5 MM	5
50026729	ALUMINIUM WASHER 20,0X26,0X1,5 MM	8

80967226 KIT RUBBER		
N° ABR	DESCRIPTION	QTD
50011020	COPPER WASHER 7,3X15,2X1,0 MM	4
50011024	COPPER WASHER 7,3X15,2X2,0 MM	4

N° SET	DESCRIPTION
60913761	FULL GASKET SET P6354/P6354.4 WITHOUT OIL SEAL 1
70913761	FULL GASKET SET P6354/P6354.4 WITHOUT OIL SEAL 2
70933761	HEAD GASKET SET P6354/P6354.4 WITHOUT OIL SEAL 3
60913763	FULL GASKET SET P6354/P6354.4 WITHOUT OIL SEAL 4

N° ABR	N° ORIGINAL	DESCRIPTION			
RE02590F		VALVE STEM SEAL		12	12
50909390	70490355	REAR COVER GASKET	1	1	1 1
50013349	02132	INJECTION PUMP GASKET			1
50922198	70490352	GASKET	1		1 1
50922298	36814124	TIMING COVER GASKET	1		1 1
50922898	36861745	THERMOSTATIC GASKET	1	1	1 1
50924190	70490363	INJECTION PUMP GASKET	1		1 1
50924280	36831122	OIL PUMP GASKET	1		1 1
50924412	70490414	GASKET	1		1 1
50925570	36865532	OIL PUMP GASKET	1		1 1
50925698	70490378	ACTUATOR TACHIMETER GASKET	1		1 1
50931498	36867162	WATER PUMP GASKET	1	1	1 1
50931757	36862507	ACTUATOR TACHIMETER GASKET	1		1 1
50931850	36826107	INSPECTION COVER GASKET	1		1 1
50932453	70490177	OIL PAN GASKET	1		1 1
50932490	70490371	OIL PAN GASKET	1		1 1
50932831	36862191	INTAKE EXHAUST MANIFOLD GASKET	2	2	2 2
50934098	70490346	OIL PUMP TUBE GASKET	1		1 1
50934198	70490347	BLOCK COVER GASKET	1		1 1
50934616	70490373	OUTLET EXHAUST GASKET	1	1	1 1
50937298	70490725	WATER PUMP GASKET	1		1 1
50937798	70490725	AIR FILTER GASKET	1	1	1 1
50938030	70490374	INTAKE MANIFOLD GASKET	2	2	2 2
50938170	70490160	EXHAUST GASKET	1		1 1
50940598	70490198	OIL NOZZLE GASKET	3	3	3 3
50941055	70490265	VALVE COVER GASKET	1	1	1 1
50942198	70490154	FUEL PUMP GASKET	1		1 1
50943398	36856102	OIL FILTER GASKET	1		1 1
50944532	70490335	INTAKE EXHAUST MANIFOLD GASKET	1	1	1 1
50945431	36866746	INTAKE MANIFOLD GASKET	2	2	2 2
50945598	70490161	OIL FILTER GASKET	1		1 1
50945772	36866105	INJECTION PUMP GASKET	1		1 1
50945898	36822118	COMPRESSOR GASKET	1		1 1
50945998	36822118	GASKET	1		1 1
50950716	36831127	OIL PAN GASKET			
50954498	70490405	OIL NOZZEL JOIN GASKET	1	1	1 1
50954598	36833144	GASKET	1		2 2
50954698	36833148	THERMOSTATIC COVER GASKET	1	1	1 1
50954798	70490330	OIL FILTER GASKET	1	1	1 1
50954898	36861448	OUTLET WATER PUMP GASKET	1		1 1
50958398	70490321	OIL FILTER GASKET			
50958698	36866207	WATER PUMP GASKET	1		1 1
50958698	70490410	WATER PUMP GASKET			
50960096		OUTLET WATER PUMP GASKET			
50971600	70490238	CYLINDER HEAD GASKET	1	1	1 1
50976598	36814202	OIL FILTER COVER GASKET			
80963731	36866749	KIT TURBOCHARGING	1		
80977840		KIT WASHERS AND RUBBERS	1	1	1 1
RE01050S		PULLEY OIL SEAL			1
RE01972S		REAR OIL SEAL			1

●SOLD SEPARATELY

P6354/P6354.4

APPLICATION



PERKINS P6354/P6354.4 6 CYL.5.8L VEICULAR/AGRÍCOLA
CHRYSLER TRUCK DODGE D700/750/900 1970/81
MASSEY FERGUSON TRACTOR MF 296 1976/89
PERKINS P6354.4/Q20B 6 CYL.5.8L TURBO VEICULAR/AGRÍCOLA
CHEVROLET TRUCK DS12000/14000 1992/96
MASSEY FERGUSON TRACTOR MF 500B 1982/87
PERKINS P6354.4 6 CYL.5.8L TURBO
MASSEY FERGUSON TRACTOR MF 297 1989/92 MF 299 1989/9

P6354/P6354.4

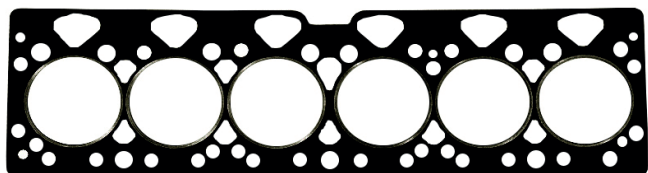

50971600



50941055

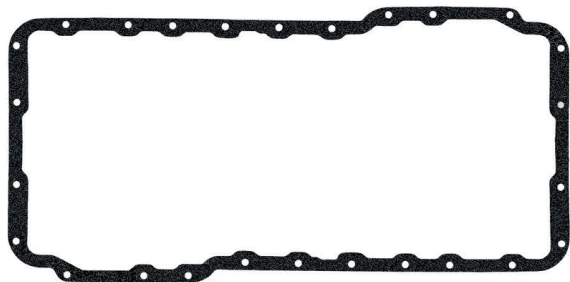

50932490

50932453

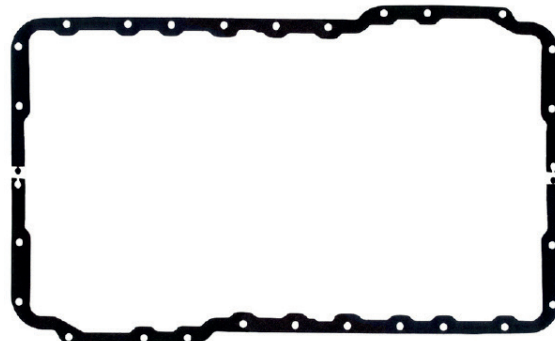

50950716

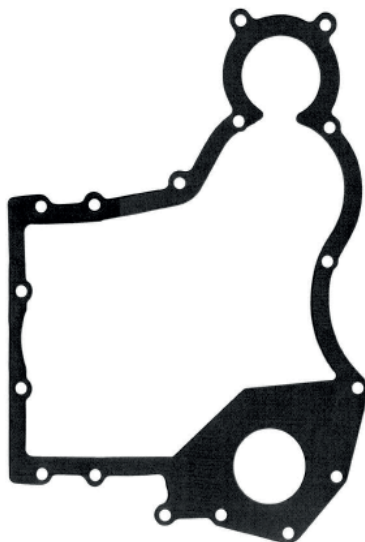

50922298

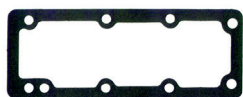

50954698

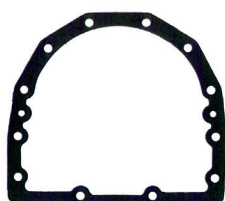

50934198

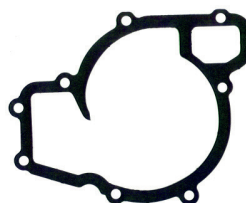

50931498

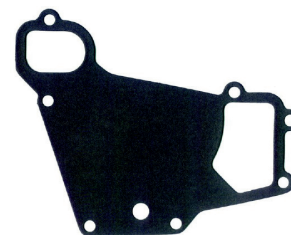

50958698

P6354/P6354.4

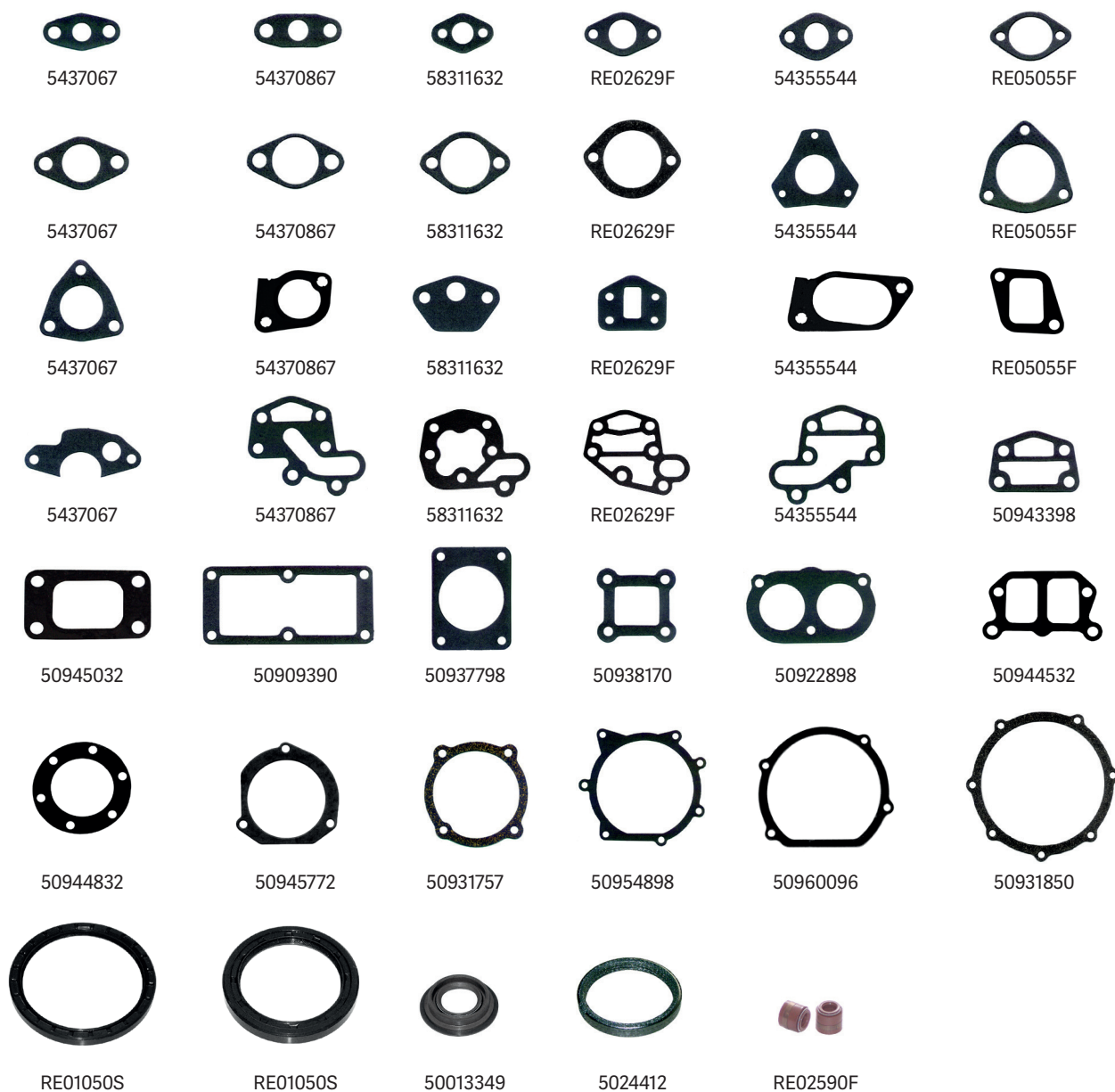

80977840		KIT RUBBER	
N° ABR	N° ORI	DESCRIPTION	QTD
50937620	70920081	WASHER INJECTION 10,0X19,2X2,0 MM	6
50967840	70730046	INJECTION PORT SEAL	6
50972641	32811408	SEAL	4
50963941	33811113	FUEL LINE SEAL	1
50964041	33817132	VALVE COVER	4
50927541	2415813	SEAL 88,0X2,5 MM	1

N° SET		DESCRIPTION			
60913761		FULL GASKET SET P654/P6354.4 WITHOUT OIL SEAL			1
70913761		FULL GASKET SET P654/P6354.4 WITHOUT OIL SEAL			2
70933761		HEAD GASKET SET P654/P6354.4 WITHOUT OIL SEAL			3
60913763		FULL GASKET SET P654/P6354.4 WITHOUT OIL SEAL			4
N° ABR	N° ORIGINAL	DESCRIPTION			
RE02590F		VALVE STEM SEAL	12	12	12
50909390	70490355	REAR CYLINDER COVER GASKET	1	1	1
50013349	02132	INJECTOR PUMP GASKET		1	1
50922198	70490352	GASKET		1	1
50922298	36814124	INSPECTION COVER GASKET		1	1
50922898	36861745	THERMOSTATIC GASKET	1	1	1
50924190	70490363	COUPLING INJECTION PUMP GASKET		1	1
50924280	36831122	OIL PUMP GASKET		1	1
50924412	70490414	GASKET		1	1
50925570	36865532	OIL PUMP GASKET		1	1
50925698	70490378	ACTUATOR TACHIMETER GASKET		1	1
50931498	36867162	WATER PUMP GASKET	1		1
50931757	36862507	ACTUATOR TACHIMETER GASKET		1	1
50931850	36826107	INSPECTION COVER GASKET		1	1
50932453	70490177	OIL PAN GASKET			1
50932490	70490371	OIL PAN GASKET			1
50932831	36862191	INTAKE EXHAUST MANIFOLD GASKET	2	2	2
50934098	70490346	OIL PUMP TUBE GASKET		1	1
50934198	70490347	REAR OIL SEAL		1	1
50934616	70490373	OUTLET EXHAUST MANIFOLD GASKET	1	1	1
50937298	70490725	WATER PUMP GASKET		1	1
50937798	70490725	AIR FILTER GASKET	1	1	1
50938030	70490374	INTAKE MANIFOLD GASKET	2	2	2
50938170	70490160	EXHAUST GASKET		1	1
50940598	70490198	OIL NOZZLE GASKET	3	3	3
50941055	70490265	VALVE COVER GASKET		1	1
50942198	70490154	FUEL PUMP GASKET		1	1
50943398	36856102	OIL FILTER GASKET		1	1
50944532	70490335	INTAKE EXHAUST MANIFOLD GASKET	1	1	1
50945431	36866746	INTAKE MANIFOLD GASKET	2	2	2
50945598	70490161	OIL FILTER GASKET		1	1
50945772	36866105	INJECTOR PUMP GASKET		1	1
50945898	36822118	COMPRESSOR GASKET		1	1
50945998	36822118	GASKET		1	1
50950716	36831127	OIL PAN GASKET		1	1
50954498	70490405	INTAKE EXHAUST GASKET	1	1	1
50954598	36833144	GASKET		1	1
50954698	36833148	THERMOSTATIC COVER GASKET	1	1	1
50954798	70490330	OIL FILTER GASKET	1	1	1
50954898	36861448	OUTLET WATER PUMP GASKET		1	1
50958398	70490321	OIL FILTER GASKET		1	1
50958698	36866207	WATER PUMP GASKET		1	1
50958698	70490410	WATER PUMP GASKET		1	1
50960096		OUTLET WATER PUMP GASKET		1	1
50971600	70490238	CYLINDER HEAD GASKET	1	1	1
50976598	36814202	FILTER HOUSING GASKET		1	1
80963731	36866749	KIT TURBOCHARGING	1	1	1
80977840		KIT WASHER AND RUBBER		1	1
RE01050S		PULLEY OIL SEAL		1	1
RE01972S		REAR OIL SEAL	1	1	1

● SOLD SEPARATELY

P6354/P6354.4

APPLICATION



PERKINS P4203 INDIRECT INJECTION 4 CYL 3.3L

FORD TRACTOR 8BR 1961/67

PERKINS P4203 INDIRECT INJECTION 4 CYL 3.3L

MASSEY FERGUSON TRACTOR MF 65 1965/82 CBT TRACTOR 1000 1975/...CASE TRACTOR 580E 1972/85

P6354/P6354.4

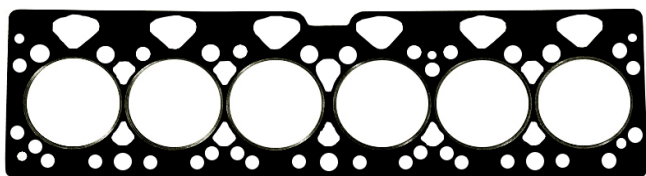

50971600



50941055

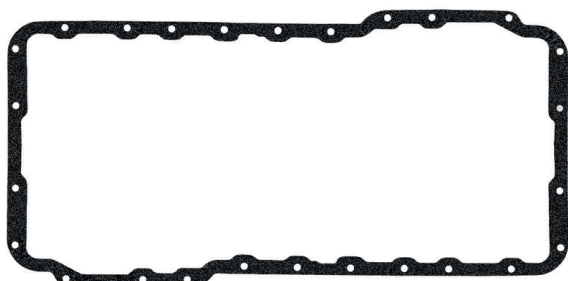

50932490

50932453

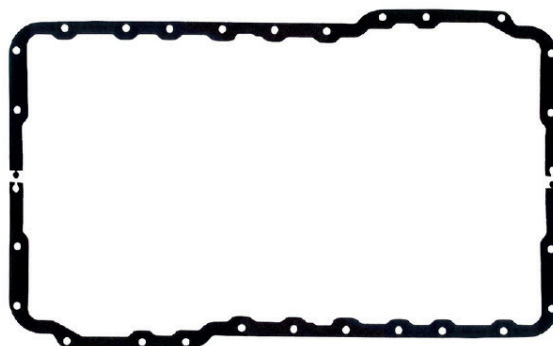

50950716

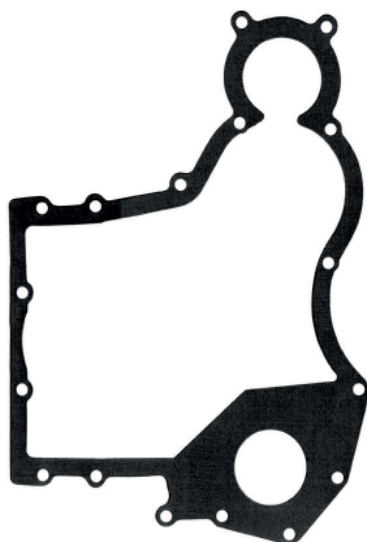

50922298

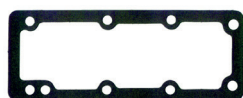

50954698

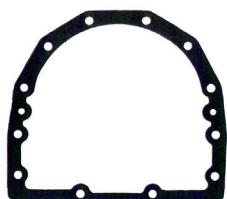

50934198

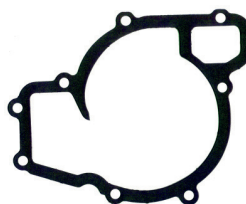

50931498

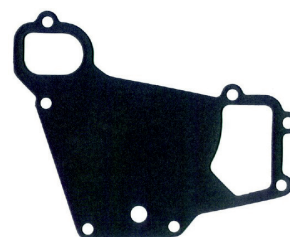

50958698

P6354/P6354.4

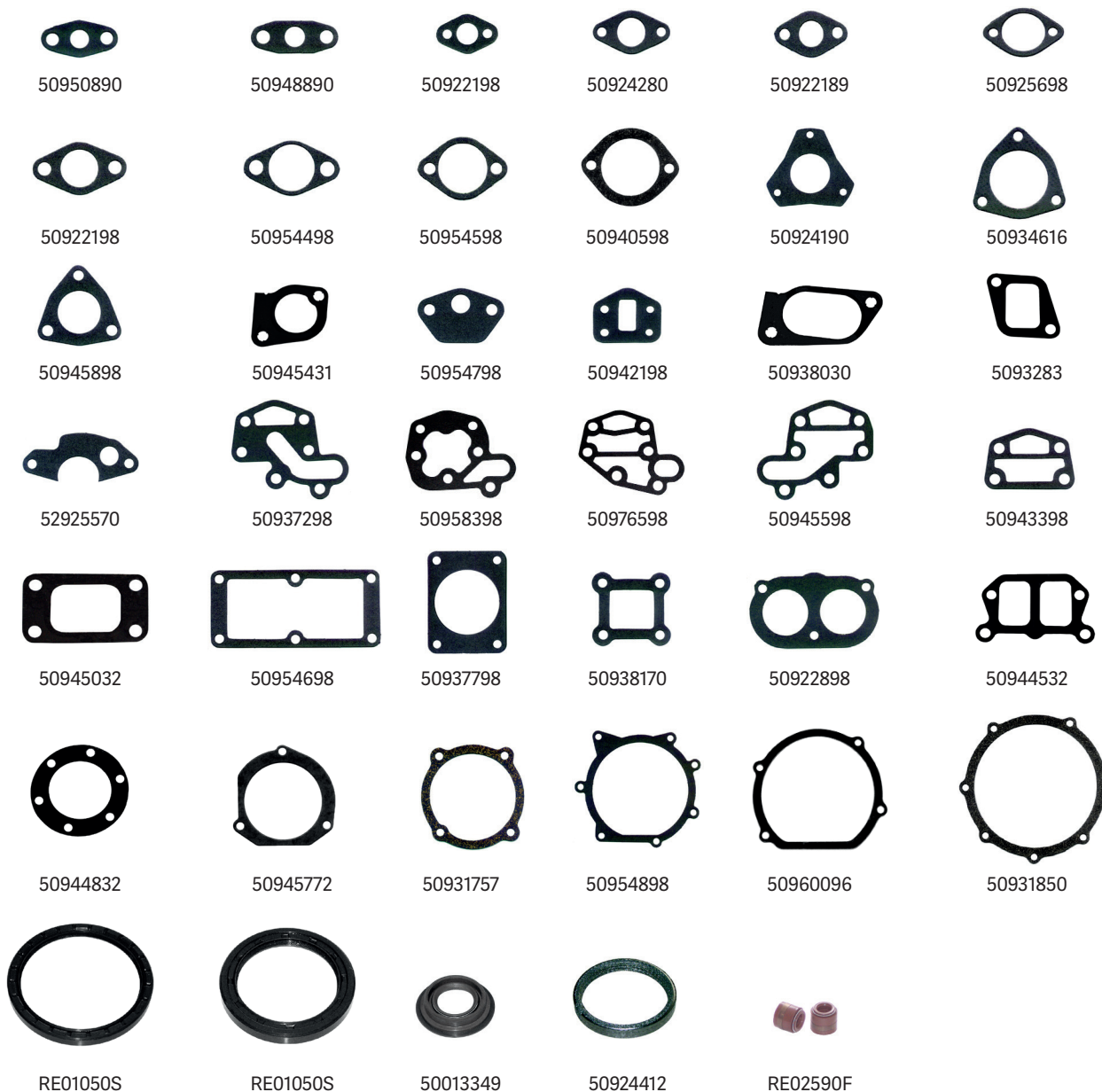

80977840		KIT RUBBER	
N° ABR	N° ORIG	DESCRIPTION	QTD
50937620	70920081	INJECTOR NOZZLE WASHER10,0X19,2X2,0 MM	6
50967840	70730046	INJECTION PORT SEAL	6
50972641	32811408	SEAL	4
50963941	33811113	FUEL LINE SEAL	1
50964041	33817132	VALVE SEAL	4
50927541	2415813	SEAL 88,0X2,5 MM	1

N° SET	DESCRIPTION	
60912881	FULL GASKET SET P6357 WITHOUT OIL SEAL	1
70912881	FULL GASKET SET P6357 WITH OIL SEAL	2
70932881	HEAD GASKET SET P6357 WITH OIL SEAL	3

N° ABR	N° ORIGINAL	DESCRIPTION			
RE00586S		PULLEY OIL SEAL			1
50906217	70490020	EXHAUST TUBE GASKET	1	1	1
50050567		GASKET		2	2
50906190	70490340	ACTUATOR TACHIMETER GASKET		1	1
50907390	70490349	OIL SEAL COVER GASKE		1	1
50907498	70490350	OUTLET TUBE OIL PUMP GASKET		1	1
50907850	70490201	WATER COVER GASKET		2	2
50907998	70490288	BLOCK NOZZLE GASKET		1	1
50908390	70490351	REAR COVER GASKET	1	1	1
50908498	70490723	INTAKE ANIFOLD GASKET	1	1	1
50908716	70490123	INTAKE MANIFOLD GASKET	1	1	1
50909616	70490358	INTAKE EXHAUST MANIFOLD GASKET	3	3	3
50909798	70490745	THERMOSTATIC GASKET	1	1	1
50909855	70490139	VALVE COVER GASKET	1	1	1
509105067	70409393	OIL PAN GASKET		1	1
50910998	70490336	WATER PUMP GASKET		1	1
50914198	70490381	FUEL PUMP GASKET		1	1
50915401	70490743	CYLINDER HEAD GASKET	1	1	1
50915698	70490049	OIL PUMP GASKET		2	2
50915798	70490392	WATER PUMP GASKET		1	1
50915953	70490132	OIL PAN GASKET		1	1
50916098	70490063	OIL PUMP GASKET		1	1
50916152	70490065	INSPECTION COVER GASKET		2	2
50916298	70490071	OUTLET WATER CONECTION GASKET	1	1	1
50916398	70490073	FRONT OUTLET CONNECTION WATER PUMP GASKET	1	1	1
50916796	70490395	INTAKE MANIFOLD GASKET	1	1	1
50916898	70490092	INSPECTION COVER GASKET		1	1
50918998	70490136	FUEL PUMP GASKET		1	1
50919098	70490397	FUEL PUMP GASKET		1	1
50924412	70490414	OUTLET EXHAUST MANIFOLD GASKET	1		1
50927098	70490304	INSPECTION COVER GASKET		1	1
50930998	70490091	OIL PUMP NOZZLE GASKET		1	1
50931698	70490143	OIL FILTER GASKET		2	2

● SOLD SEPARATELY

P6357

APPLICATION



PERKINS P6357/P6357.2 6 CYL.5.8L VEICULAR/AGRÍCOLA

FORD TRUCK F11000/F12000/F13000 1981/81

M.FERGUSON TRACTOR MF 3366 1971/74 ; MF 400 1976/84 ; MF 500B 1974/82 ; MF 95X 1973/85

CHRYSLER TRUCK DODGE D700/750/900 1975/81

CHEVROLET TRUCK D60 1965/85 ; D79/75 1970/85

DS14 - LK140 / LK141 8 CYLINDERS 1974

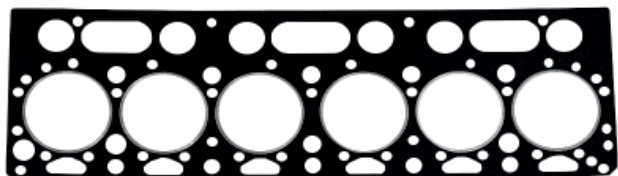

50915401

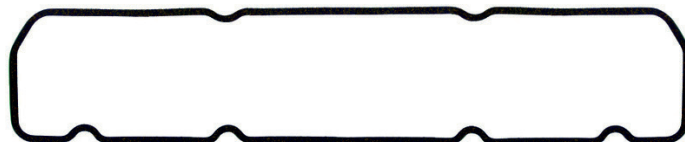

50909855



509105067



50915953

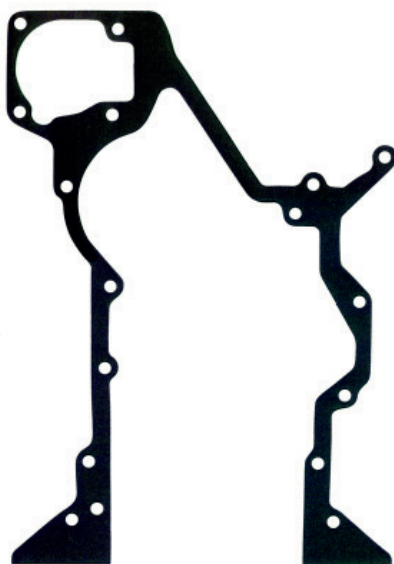

50916898

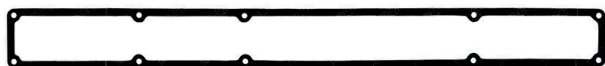

50916796



50907850

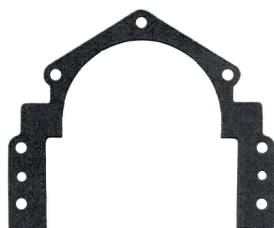

50907390



50916152

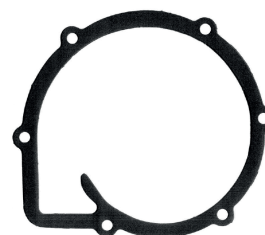

50915798

DS14 - LK140 / LK141 8 CYLINDERS 1974



50907998



50915698



50908498



50907498



50908498



50906217



50916298



50916398



50931698



5090616



50914198



50919095



50916098



50906190

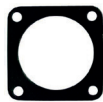

50908716



50910998



50918998



RE05055F

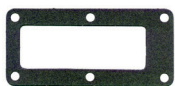

50908390



50927098



RE00586S



50924412



50050567

80956190		KIT RUBBER
N° ABR	DESCRIPTION	QTD
50022224	WASHER 14,0X20,8X1,5 MM	6
50035623	COPPER WASHER 40,3X46,7X1,0 MM	6
50945641	SEAL	12

N° SET		DESCRIPTION				
60913439		FULL GASKET SET WITHOUT OIL SEAL				1
70913439		HEAD GASKET SET WITHOUT OIL SEAL				2
70933431		BOTTOM GASKET SET WITHOUT OIL SEAL				3
60933431		BOTTOM GASKET SET WITHOUT OIL SEAL				4
N° ABR	N° ORIGINAL	DESCRIPTION				
RE02590F		VALVE STEM SEAL		12	12	
50905650	70490096	VALVE COVER GASKET	1	1	1	1
50906190	70490340	ACTUATOR TACHIMETER GASKET			1	1
50906217	70490020	OUTLET EXHAUST MANIFOLD GASKET			1	1
50906716	70490106	INTAKE EXHAUST MANIFOLD GASKET	1	1	1	1
50907498	70490350	TUBE OUTLET OIL PUMP GASKET			1	1
50907850	70490101	WATER COVER GASKET			2	2
50907998	70490288	BLOCK NOZZLE GASKET			1	1
50908498	70490421	INTAKE MANIFOLD GASKET	1	1	1	1
50908716	70490400	OUTLET INTAKE MANIFOLD GASKET	1	1	1	1
509104967	70490393	OIL PAN GASKET			1	1
50910998	70490734	WATER PUMP GASKET			1	1
50914198	70490381	FUEL PUMP GASKET			1	1
50915698	70490049	OIL PUMP TUBE GASKET			1	1
50915798	70490392	WATER COVER GASKET			1	1
50915953	70490132	OIL PAN GASKET			1	1
50916098	70490063	OIL PUMP GASKET			1	1
50916152	70490065	INSPECTION COVER GASKET			2	2
50917098	704490097	INSPECTION COVER GASKET			1	1
50917116	70490107	INTAKE SIDE EXHAUST GASKET	2	2	2	2
50917398	70490114	REAR COVER GASKET		1	1	1
50917598	70490128	TIMING COVER GASKET			1	1
50918995	70490112	FUEL PUMP GASKET			1	1
50919098	70490397	FUEL PUMP GASKET			1	1
50924412	70490414	OUTLET EXHAUST MANIFOLD GASKET		1	1	1
50926950	70490026	ACTUATOR TACHIMETER GASKET			1	1
50927098	70490394	INSPECTION OVER GASKET			1	1
50927198	70490069	EXHAUST TUBE GASKET			1	1
50930409	70490196	CYLINDER HEAD GASKET		1	1	1
50930590	70490809	WATER COVER GASKET		2	2	2
50930690	70490117	INTAKE MANIFOLD GASKET		2	2	2
50930790	70490201	INTAKE MANIFOLD GASKET (CENTER)		2	2	2
50930890	70490119	HEAD THERMOSTATIC GASKET		1	1	1
50930998	70490091	OIL PUMP NOZZLE GASKET			1	1
50931698	70490143	OIL FILTER GASKET			1	1
50934598	70490116	REAR CYLINDER COVER GASKET		1	1	1
50959967	70490153	INTAKE EXHAUST MANIFOLD GASKET		4	4	4
80978126		KIT WASHERS AND RUBBERS		1	1	1
RE01050S		PULLEY OIL SEAL			1	
RE01972S		REAR OIL SEAL			1	

• SOLD SEPARATELY

P6358

APPLICATION



PERKINS P6358 6 CYL.5.8L VEICULAR/AGRÍCOLA

FORD TRUCK F11000/F12000/F13000 1982/92

M.FERGUSON TRACTOR MF 295 1976/89 MF 400C 1971/74

CHEVROLET TRUCK D11000/D13000/19000/21000/22000 1985/91 D12000 1991/96

P6358

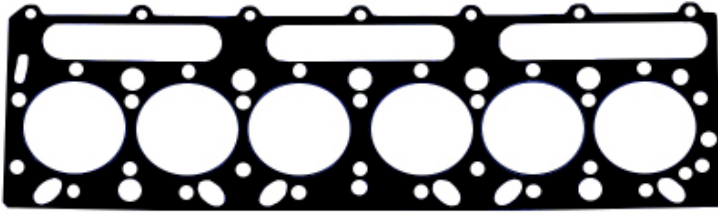

50930409

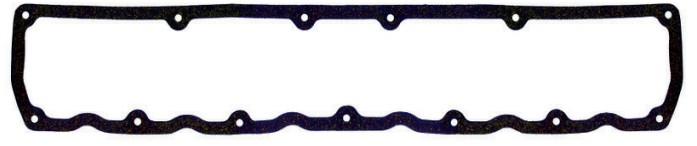

50905650

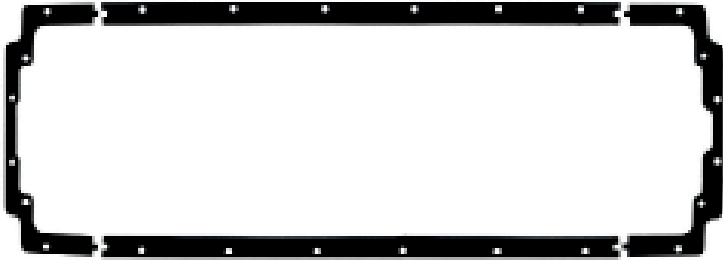

509104967



50915953

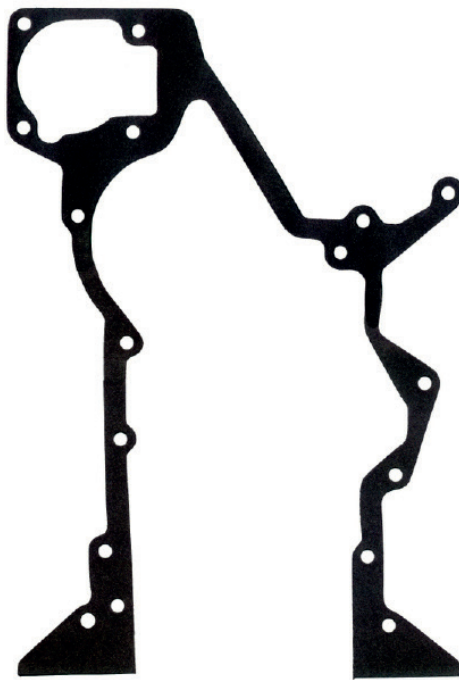

50917098

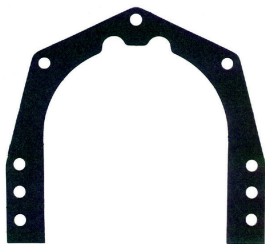

50917598



50916152

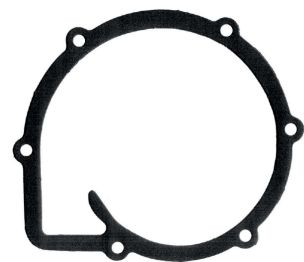

50915798

P6358



50906716



50907850



50927198



50907998



50907498



50915698



50930998



50908498



50906217



50916098



50930590



50930690



50931698



50914198



50919095



50906190

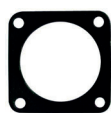

50908716



50926950



50910998



50918995



RE05055F



50930890



509030790



50917116



50934598



50917390



50927098



RE01972S



RE01050S



50924412



50959967



RE02590F

80978126 KIT RUBBER		
N° ABR	DESCRIPTION	QTD
50011228	ALUMINIUM WASHER 8,0X12,8X1,0 MM	13
50019725	ALUMINIUM WASHER 13,2X17,1X2,0 MM	12
50014029	ALUMINIUM WASHER 10,0X14,1X1,5 MM	12
50014024	COPPER WASHER 9,6X18,0X1,5 MM	6
50937620	COPPER WASHER 10,0X19,2X2,0 MM	6



IVECO

N° ABR	ENGINE	DESCRIPTION		PAGE
63510101	DUCATO 2.5/2.8	FULL GASKET SET	WITHOUT OIL SEAL	180
73510121	DUCATO 2.5/2.8	FULL GASKET SET	WITH OIL SEAL	180
63510121	DUCATO 2.5/2.8	HEAD GASKET SET	WITHOUT OIL SEAL	180
73510121	DUCATO 2.5/2.8	HEAD GASKET SET	WITH OIL SEAL	180
73530101	DUCATO 2.5/2.8	BOTTOM GASKET SET	WITHOUT OIL SEAL	180
73510131	DUCATO 2.8	BOTTOM GASKET SET	WITH INDIRECT INJECTION WITH OIL SEAL	184
63540131	DUCATO 2.8	FULL GASKET SET	WITH INDIRECT INJECTION WITHOUT OIL SEAL	184
73540131	DUCATO 2.8	HEAD GASKET SET	WITH INDIRECT INJECTION WITHOUT OIL SEAL	184
73530101	DUCATO 2.5/2.8	BOTTOM GASKET SET	WITH INDIRECT INJECTION WITHOUT OIL SEAL	184
73510162	JTD 2.3	FULL GASKET SET	WITHOUT OIL SEAL	188
73530162	JTD 2.3	FULL GASKET SET	WITH OIL SEAL	188
73510182	F1CE0481D	HEAD GASKET SET	WITHOUT OIL SEAL	190
73530182	F1CE0481D	HEAD GASKET SET	WITH OIL SEAL	190
73510202	CURSOR 8	BOTTOM GASKET SET	WITHOUT OIL SEAL	192
73530202	CURSOR 8	BOTTOM GASKET SET	WITH OIL SEAL	192
73510252	CURSOR 9	FULL GASKET SET	WITHOUT OIL SEAL	194
73530252	CURSOR 9	FULL GASKET SET	WITH OIL SEAL	194
73510352	CURSOR 10	HEAD GASKET SET	WITHOUT OIL SEAL	196
73530352	CURSOR 10	HEAD GASKET SET	WITH OIL SEAL	196
73510302	CURSOR 13	BOTTOM GASKET SET	WITHOUT OIL SEAL	198
73530302	CURSOR 13	BOTTOM GASKET SET	WITH OIL SEAL	198

IVECO DUCATO 2.5 / 2.8 TURBO DIESEL

N° SET	DESCRIPTION				
63510101	FULL GASKET SET IVECO 2.5/2.8 DIRECT INJECTION WITHOUT OIL SEAL				1
73510101	FULL GASKET SET IVECO 2.5/2.8 DIRECT INJECTION WITH OIL SEAL				2
63510121	FULL GASKET SET IVECO 2.5 INDIRECT INJECTION(DAILY 30.8/35.8/40.8/FIAT DUCATO/RENAULT MASTER)WITHOUT OIL SEAL				3
73510121	FULL GASKET SET IVECO 2.5 INDIRECT INJECTION(DAILY 30.8/35.8/40.8/FIAT DUCATO/RENAULT MASTER)WITH OIL SEAL				4
73530101	HEAD GASKET SET IVECO 2.5/2.8 DIRECT INJECTION(FIAT DUCATO/RENAULT MASTER)WITH OIL SEAL				5

N° ABR	N° ORIGINAL	DESCRIPTION					
50945032	36885008	TURBOCHARIGNG GASKET	1	1	1		
50951832	3688A004	ELBOW TURBOCHARIGNG GASKET	1	1	1		
53500300	99432354	CYLINDER HEAD GASKET					1
53500530	99436990	ELBOW TURBOCHARIGNG GASKET					1
53501940	500388382	VALVE COVER GASKET	1				1
53502018	98434020	EXHAUST MANIFOLD GASKET	4	4	4	4	
53502330	93255173	ELBOW TURBOCHARIGNG GASKET					1
53502418	98484659	TURBOCHARIGNG GASKET					1
53502547	98425767	INTAKE MANIFOLD GASKET	4	4	4	4	
53502750		OIL NOZZLE GASKET	1	1	1	1	
53502967	500310543	VACCUM PUMP GASKET	1	1	1		
53503067	53503067	OIL FILTER GASKET	1	1	1		
53503167		REAR COVER GASKET	1	1	1		
53503267		COOLER GASKET	1	1	1		
53503367		INLET OIL TURBOCHARGING GASKET	1	1	1		
53503467		FUEL PUMP GASKET	1	1	1		
53503567		WATER PIPE GASKET	4	4	4		
53503667		OUTLET OIL TURBOCHARGING GASKET	1	1	1		
53503767		WATER PIPE GASKET	1	1	1	1	1
53503867	98421275	FRONT COVER GASKET	1	1	1	1	1
53503967	500329904	THERMOSTATIC GASKET	1	1	1	1	1
53504067	500349423	OIL FILTER GASKET	1	1	1	1	1
53504167	500329970	INSPECTION COVER GASKET	1	1	1	1	1
53504367	98421263	FRONT COVER GASKET	1	1	1	1	1
53504467		REAR GASKET	1	1	1	1	1
53504567	4851923	INJECTOR PUMP GASKET	1	1	1	1	1
53504667		REAR COVER GASKET	1	1	1	1	1
53504767	98444187	TURBOCHARGING GASKET	1	1	1	1	1
53504940	99432807	LEFT OIL PAN GASKET	1	1	1	1	1
53505040	99432808	RIGHT OIL PAN GASKET	1	1	1	1	1
53505367		FRONT COVER GASKET	1	1	1	1	1
53505467	99436992	LUBRICANT PIPE GASKET	1	1	1		
53505500	98492580	CYLINDER HEAD GASKET	1	1	1		
53505640	500316259	VALVE COVER GASKET	1	1	1		
54424136	4834948	TURBOCHARIGNG GASKET		1	1		
83500120		KIT WASHERS					1
83500241		KIT RUBBERS	1	1	1		
83500320		KIT WASHERS	1	1	1		
83500441		KIT RUBBERS					1
53502650		OIL PAN GASKET					1
53502850		OIL PAN GASKET	1	1	1	1	1
RE05537F	99433995	CAMSHAFT SEAL	1	1	1	1	1
RE09038F	99457401	FRONT OIL ESAL		1			1
RE09039F	99483227	REAR CRANKSHAFT OIL SEAL		1			1
RE09284F	9060530358	VALVE STEM SEAL		1			1

● SOLD SEPARATELY

IVECO DUCATO 2.5 / 2.8 TURBO DIESEL

APPLICATION



IVECO TURBODAILY 1996/...

FIAT DUCATO 14 1998/01 MAXI 18 1996/02

CITROEN JUMPER II HDI 2004/...JUMPER HDI 2000/06

PEUGEOT BOXER HDI/TDI 2000/01 BOXER 4X4 HDI 2002/...

RENAULT MASTER II 1998/03

IVECO TURBODAILY 1987/89

FIAT DUCATO TD 1985/88

RENAULT TRAFIC 1997/...

IVECO DAILY 30.8/35.8 1996/...

FIAT DUCATO 14/MAXI 18 1998/01

CITROEN JUMPER 2001/02

PEUGEOT BOXER 2000/02

IVECO DUCATO 2.5 / 2.8 TURBO DIESEL

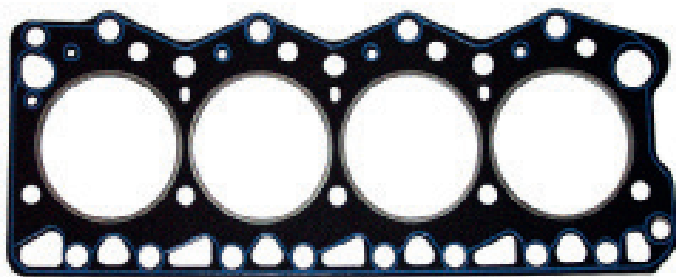

53500300

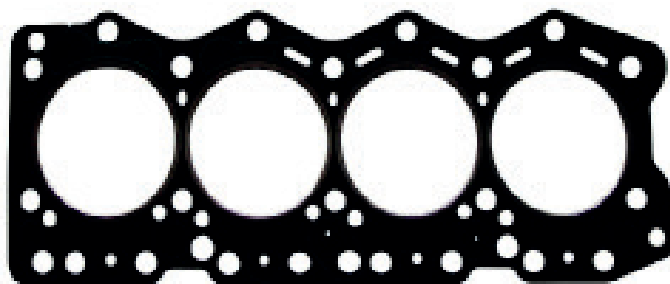

53505500

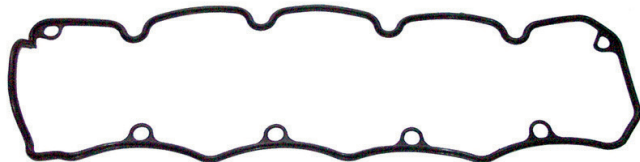

53501940



53505640

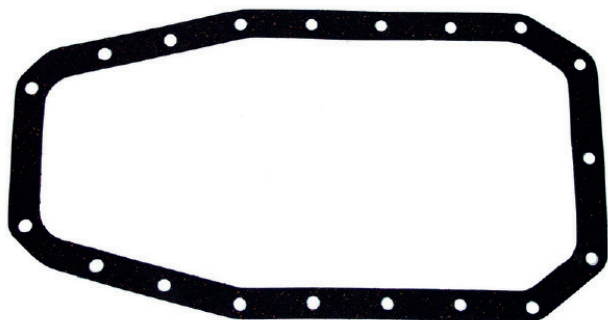

53502650

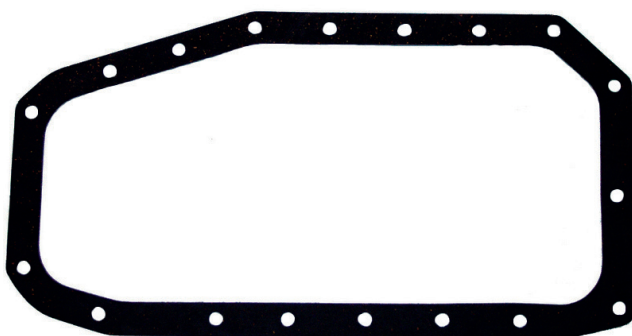

53502850



53505040



53505367

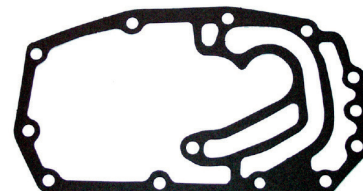

53504367



53502330



53502418

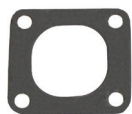

53500530



53503567



53503767



53502547



54424136



50945032



50951832



53504767



53504567



53502018



53503967

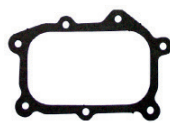

53503167

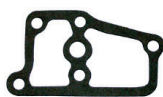

53504067



53503267



53504167



53503067

IVECO DUCATO 2.5 / 2.8 TURBO DIESEL



83500441		KIT RUBBERS	
N° ABR	DESCRIPTION	QTD	
17281881	SEAL 17,2X2,6 MM	2	
17264381	SEAL 47,2X3,5 MM	3	
17229881	SEAL 9,2X1,8 MM	3	
17288481	SEAL 17,2X1,8 MM	4	
17281981	SEAL 18,7X2,6 MM	2	
14462881	SEAL 18,0X3,5 MM	1	
17282780	SEAL 22,0X1,8 MM	2	
17282281	SEAL 23,4X2,7 MM	1	
17282681	SEAL 29,7X2,7 MM	1	
17282681	SEAL 37,8X2,7 MM	1	
17289681	SEAL 44,0X3,5 MM	1	
17283881	SEAL 49,0X2,7 MM	1	
17280280	SEAL 56,9X1,8 MM	1	
17274281	SEAL 55,0X2,6 MM	1	
17290180	SEAL 59,92X3,6MM	1	
17284880	SEAL 64,7X2,7 MM	1	
17291381	SEAL 94,8X3,5 MM	1	
17291381	SEAL 98,0X3,5 MM	1	
14464880	SEAL 62,9X3,5 MM	1	
14471780	SEAL 66,0X5,4 MM	1	

83500241		KIT RUBBERS	
N° ABR	DESCRIPTION	QTD	
17281881	SEAL 17,2X2,6 MM	1	
17281383	SEAL 9,2X2,6 MM	3	
17282082	SEAL 19,7X2,0 MM	2	
17288581	SEAL 18,5X1,8 MM	2	
17286882	SEAL 20,6X1,8 MM	2	
17282281	SEAL 23,4X2,7 MM	1	
17282083	SEAL 20,0X2,7 MM	16	
17282681	SEAL 29,7X2,7 MM	2	
17283881	SEAL 49,0X2,7 MM	1	
17280281	SEAL 56,9X1,8 MM	2	
17282181	SEAL 21,9X2,6 MM	1	
17284880	SEAL 64,7X2,7 MM	1	
17291381	SEAL 98,0X3,5 MM	1	

83500320		KIT RUBBERS	
N° ABR	DESCRIPTION	QTD	
50015423	COPPER WASHER 10,0X13,8X1,0 MM	4	
50013022	COPPER WASHER 8,0X13,8X0,80 MM	4	
	ALUMIUM WASHER 7,0X12,6X1,6 MM	4	
50018724	COPPER WASHER 12,0X18,0X1,6 MM	4	
50021224	COPPER WASHER 14,0X20,0X1,5 MM	4	
50070324	COPPER WASHER 18,0X22,0X1,5 MM	1	
50026723	COPPER WASHER 20,0X26,0X1,0 MM	1	
	COPPER WASHER 20,0X26,0X0,70MM	1	
50072424	COPPER WASHER 22,0X27,0X1,5 MM	1	

83500120		KIT RUBBERS	
N° ABR	DESCRIPTION	QTD	
50018723	COPPER WASHER 12,0X18,0X1,0 MM	4	
	COPPER WASHER 9,1X13,8X0,5 MM	5	
50026724	COPPER WASHER 20,0X26,0X1,5 MM	3	
50021124	ALUMIUM WASHER 14,0X18,0X1,5 MM	4	
50028724	COPPER WASHER 22,3X27,9X1,5 MM	4	
50030724	COPPER WASHER 28,3X37,4X1,5 MM	1	
50015423	COPPER WASHER 10,0X13,8X1,0 MM	2	
50015428	ALUMIUM WASHER 10,0X13,8X1,0 MM	1	

IVECO DUCATO 2.5 / 2.8 TURBO DIESEL

N° SET		DESCRIPTION			
73510131	FULL GASKET SET IVECO 2.8 INDIRECT INJECTION (DAILY 30.8/35.8/ FIAT DUCATO 14/18) WITH OIL SEAL		1		
63540131	HEAD GASKET SET IVECO 2.8 INDIRECT INJECTION (DAILY 30.8/35.8/ FIAT DUCATO 14/18) WITHOUT OIL SEAL		2		
73540131	HEAD GASKET SET IVECO 2.8 INDIRECT INJECTION (DAILY 30.8/35.8/ FIAT DUCATO 14/18) WITH OIL SEAL		3		
73530101	HEAD GASKET SET IVECO 2.5/2.8 DIRECT INJECTION (FIAT DUCATO/RENAULT MASTER) WITH OIL SEAL		4		
N° ABR	N° ORIGINAL	DESCRIPTION			
50945032	36885008	TURBOCHARIGNG GASKET	1	1	1
50951832	3688A004	ELBOW TURBOCHARIGNG GASKET	1	1	1
53500300	99432354	CYLINDER HEAD GASKET	1		
53500530	99436990	ELBOW TURBOCHARGING GASKET	1		
53501940	500388382	VALVE COVER GASKET	1	1	1
53502018	98434020	EXHAUST MANIFOLD GASKET	4	4	4
53502330	93255173	ELBOW TURBOCHARGING GASKET	1		
53502418	98484659	TURBOCHARGING MANIFOLD GASKET	1		
53502547	98425767	INTAKE MANIFOLD GASKET	4		
53502750		OIL NOZZLE GASKET	1	1	1
53502967	500310543	VACCUM PUMP GASKET	1	1	1
53503067	53503067	OIL FILTER GASKET	1	1	1
53503167		REAR COVER GASKET	1	1	1
53503267		COOLER GASKET	1	1	1
53503367		INLET OIL TURBOCHARGING GASKET	1	1	1
53503467		FUEL PUMP GASKET	1	1	1
53503567		WATER PIPE GASKET	1	1	1
53503667		OUTLET OIL TURBOCHARGING GASKET	4	4	4
53503767		WATER PIPE GASKET			1
53503867	98421275	FRONT COVER GASKET	1		1
53503967	500329904	THERMOSTATIC GASKET	1		1
53504067	500349423	OIL FILTER GASKET	1		1
53504167	500329970	INSPECTION COVER GASKET	1		1
53504367	98421263	FRONT COVER GASKET	1		1
53504467		REAR GASKET			1
53504567	4851923	INJECTOR PUMP GASKET	1		1
53504667		REAR COVER GASKET	1	1	1
53504767	98444187	TURBOCHARGING GASKET	1	1	1
53504940	99432807	LEFT OIL PAN GASKET	1	1	1
53505040	99432808	RIGHT OIL PAN GASKET	1	1	1
53505367		FRONT COVER GASKET	1	1	1
53505467	99436992	LUBRICANT PIPE GASKET	1	1	1
53505500	98492580	CYLINDER HEAD GASKET	1	1	1
53505640	500316259	VALVE COVER GASKET			1
54424136	4834948	TURBOCHARIGNG GASKET			1
83500120		KIT WASHERS			
83500241		KIT RUBBERS	1		
83500320		KIT WASHERS		1	1
83500441		KIT RUBBERS		1	1
53502650		OIL PAN GASKET			
53502850		OIL PAN GASKET	1		
RE05537F	99433995	CAMSHAFT SEAL	1		
RE09038F	99457401	FRONT OIL ESAL			
RE09039F	99483227	REAR CRANKSHAFT OIL SEAL	1		
RE09284F	9060530358	VALVE STEM SEAL	1		

● SOLD SEPARATELY

IVECO DUCATO 2.5 / 2.8 TURBO DIESEL

APPLICATION



IVECO TURBODAILY 1996/...

FIAT DUCATO 14 1998/01 MAXI 18 1996/02

CITROEN JUMPER II HDI 2004/...JUMPER HDI 2000/06

PEUGEOT BOXER HDI/TDI 2000/01 BOXER 4X4 HDI 2002/...

RENAULT MASTER II 1998/03

IVECO TURBODAILY 1987/89

FIAT DUCATO TD 1985/88

RENAULT TRAFIC 1997/...

IVECO DAILY 30.8/35.8 1996/...

FIAT DUCATO 14/MAXI 18 1998/01

CITROEN JUMPER 2001/02

PEUGEOT BOXER 2000/02

IVECO DUCATO 2.5 / 2.8 TURBO DIESEL

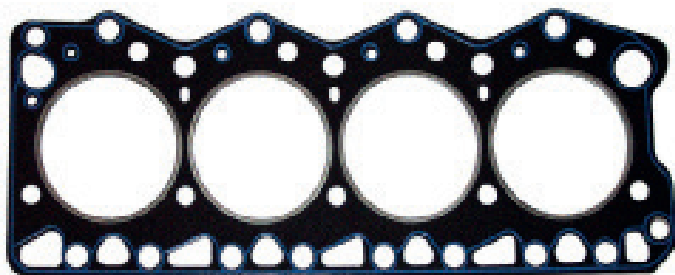

53500300

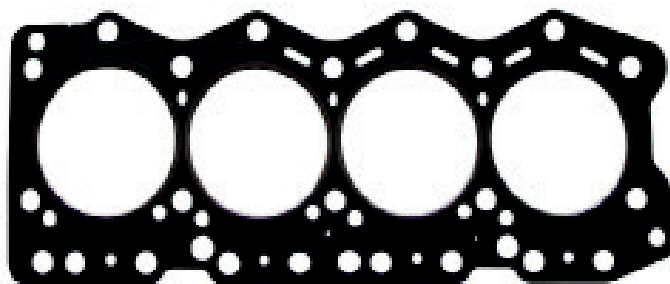

53505500

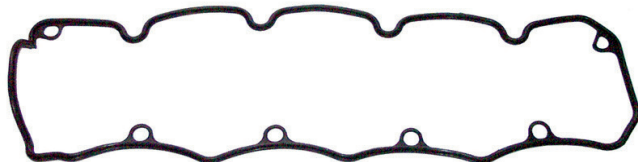

53501940



53505640

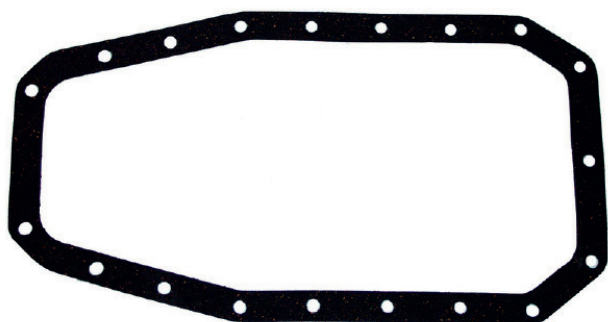

53502650

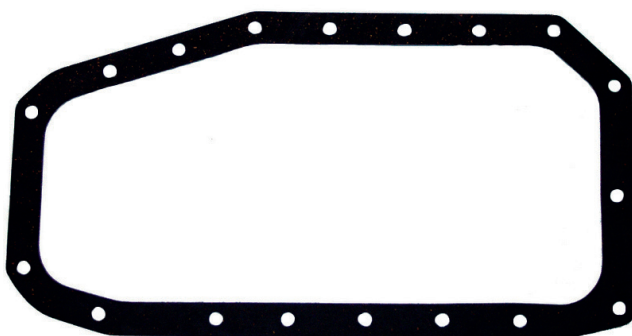

53502850



53505040



53505367

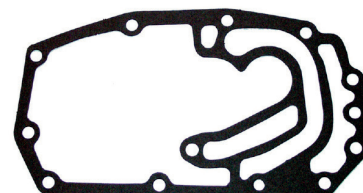

53504367



53502330

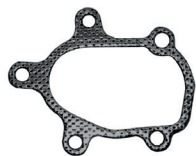

53502418

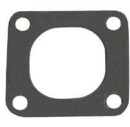

53500530



53503567



53503767



53502547



54424136



50945032



50951832



53504767



53504567



53502018



53503967

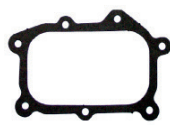

53503167

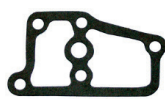

53504067



53503267



53504167



53503067

IVECO DUCATO 2.5 / 2.8 TURBO DIESEL



83500441		KIT RUBBERS	
N° ABR	DESCRIPTION	QTD	
17281881	SEAL 17,2X2,6 MM	2	
17264381	SEAL 47,2X3,5 MM	3	
17229881	SEAL 9,2X1,8 MM	3	
17288481	SEAL 17,2X1,8 MM	4	
17281981	SEAL 18,7X2,6 MM	2	
14462881	SEAL 18,0X3,5 MM	1	
17282780	SEAL 22,0X1,8 MM	2	
17282281	SEAL 23,4X2,7 MM	1	
17282681	SEAL 29,7X2,7 MM	1	
17282681	SEAL 37,8X2,7 MM	1	
17289681	SEAL 44,0X3,5 MM	1	
17283881	SEAL 49,0X2,7 MM	1	
17280280	SEAL 56,9X1,8 MM	1	
17274281	SEAL 55,0X2,6 MM	1	
17290180	SEAL 59,92X3,6MM	1	
17284880	SEAL 64,7X2,7 MM	1	
17291381	SEAL 94,8X3,5 MM	1	
17291381	SEAL 98,0X3,5 MM	1	
14464880	SEAL 62,9X3,5 MM	1	
14471780	SEAL 66,0X5,4 MM	1	

83500241		KIT RUBBERS	
N° ABR	DESCRIPTION	QTD	
17281881	SEAL 17,2X2,6 MM	1	
17281383	SEAL 9,2X2,6 MM	3	
17282082	SEAL 19,7X2,0 MM	2	
17288581	SEAL 18,5X1,8 MM	2	
17286882	SEAL 20,6X1,8 MM	2	
17282281	SEAL 23,4X2,7 MM	1	
17282083	SEAL 20,0X2,7 MM	16	
17282681	SEAL 29,7X2,7 MM	2	
17283881	SEAL 49,0X2,7 MM	1	
17280281	SEAL 56,9X1,8 MM	2	
17282181	SEAL 21,9X2,6 MM	1	
17284880	SEAL 64,7X2,7 MM	1	
17291381	SEAL 98,0X3,5 MM	1	

83500320		KIT RUBBERS	
N° ABR	DESCRIPTION	QTD	
50015423	COPPER WASHER 10,0X13,8X1,0 MM	4	
50013022	COPPER WASHER 8,0X13,8X0,80 MM	4	
	ALUMIUM WASHER 7,0X12,6X1,6 MM	4	
50018724	COPPER WASHER 12,0X18,0X1,6 MM	4	
50021224	COPPER WASHER 14,0X20,0X1,5 MM	4	
50070324	COPPER WASHER 18,0X22,0X1,5 MM	1	
50026723	COPPER WASHER 20,0X26,0X1,0 MM	1	
	COPPER WASHER 20,0X26,0X0,70MM	1	
50072424	COPPER WASHER 22,0X27,0X1,5 MM	1	

83500120		KIT RUBBERS	
N° ABR	DESCRIPTION	QTD	
50018723	COPPER WASHER 12,0X18,0X1,0 MM	4	
	COPPER WASHER 9,1X13,8X0,5 MM	5	
50026724	COPPER WASHER 20,0X26,0X1,5 MM	3	
50021124	ALUMIUM WASHER 14,0X18,0X1,5 MM	4	
50028724	COPPER WASHER 22,3X27,9X1,5 MM	4	
50030724	COPPER WASHER 28,3X37,4X1,5 MM	1	
50015423	COPPER WASHER 10,0X13,8X1,0 MM	2	
50015428	ALUMIUM WASHER 10,0X13,8X1,0 MM	1	

N° SET		DESCRIPTION		
73510162	FULL GASKET SET F1A DUCATO/PEUGEOT BOXER/RENAULT MASTER JTD 2.3 16V WITH OIL SEAL		1	
73530162	HEAD GASKET SET F1A DUCATO/PEUGEOT BOXER/RENAULT MASTER JTD 2.3 16V WITH OIL SEAL		2	
N° ABR	N° ORIGINAL	DESCRIPTION		
53501602	500387069	CYLINDER HEAD GASKET	1	1
53508940	504019494	VALVE COVER GASKET	1	1
53509040	504018307	OIL PAN GASKET	1	1
53509130	504037859	INTAKE MANIFOLD GASKET	1	1
53509247	500376626	INTAKE MANIFOLD GASKET	1	1
RE09089F	RE09089F	CAMSHAFT SEAL	1	1
RE09088F	RE09088F	VALVE STEM SEAL	16	16
RE09090T	RE09090T	REAR OIL SEAL		1
RE09091T	RE09091T	FRONT OIL SEAL		1
53509347	53509347	THERMOSTATIC GASKET	1	1
53509430	50438902	FRONT COVER GASKET		1
53511640		SLIDE COVER GASKET	1	1
53509530	53509530	TURBOCHARIGNG GASKET	1	1
53510130	53510130	ELBOW TURBOCHARIGNG GASKET	1	1
53510231	53510231	TURBOCHARGING MANIFOLD GASKET	5	5
83500740	83500740	KIT WASHERS AND RUBBERS	1	1
83500746		KIT RUBBERS	1	
53511540		THERMOSTATIC GASKET	1	1

●SOLD SEPARATELY

APPLICATION



IVECO DAILY IV/DAILY IV COMBI/DAILY III/DAILY III COMBI 2006/...DAILY III 2002/...DAILY III/DAILY III COMBI 2005/06.

FIAT DUCATO JTD 2002/06 DUCATO JTD/DUCATO COMBI D 2006/...DUCATO JTD/DUCATO D 2009/...DUCATO D/DUCATO COMBI D 2011/...

ENGINE F1AE0481C FIAT DUCATO JTD 2.3 16VALVES

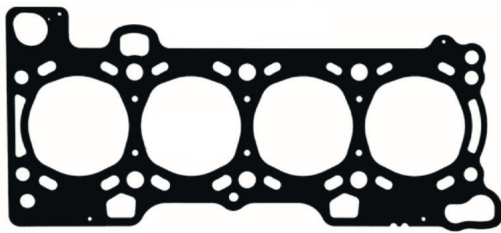

53501602



53509130

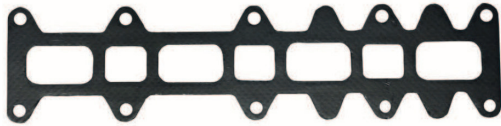

53509247

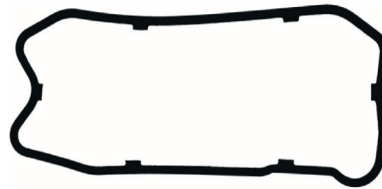

53509040

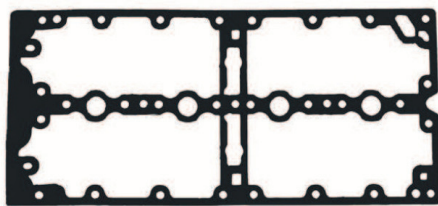

53508940



53511640



53509430



53511540



53510231



53509347



53509530



RE09090T



RE09091T



RE09089F

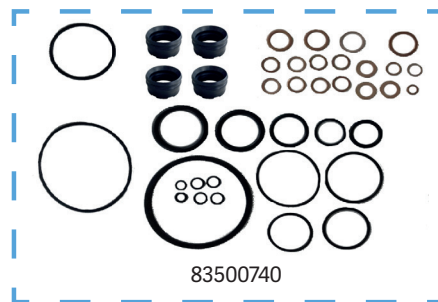

83500740



53510130



83500746



RE09088F

MT F1CE0481D FIAT DUCATO 3.0 16VALES

N° SET		DESCRIPTION		
73510182		FULL GASKET SET F1A DUCATO/PEUGEOT BOXER/RENAULT MASTER JTD 3.0 16VALVES WITH OIL SEAL	1	
73530182		HEAD GASKET SET F1A DUCATO/PEUGEOT BOXER/RENAULT MASTER JTD 3.0 16VALVES WITH OIL SEAL	2	
N° ABR	N° ORIGINAL	DESCRIPTION		
53501302	R515273	CYLINDER HEAD GASKET	1	1
53509640	R75729	OIL PAN GASKET		1
53509740	R97341	VALVE COVER GASKET	1	1
53509847	R521439	EXHAUST GASKET	1	1
53509930	R81275	INTAKE MANIFOLD GASKET	1	1
53510330	R90737	EXHAUST TUBE GASKET	2	2
RE09092T	R97352	FRONT OIL ESAL		1
RE09093T	R123570	RETENTOR TRASEIRO		1
RE09088T	R135896	VALVE STEM SEAL	16	16
53510430	T20219	FRONT COVER GASKET		1
53510231	T20243	THERMOSTATIC GASKET	1	1
53509347	T20273	EXHAUST CURVE GASKET	1	1
53510547	R27285	THROTTLE BODY GASKET	1	1
53510630	R97350	OIL COOLER GASKET	1	1
53510730	R97351	WATER PUMP GASKET		1
53510830	R97354	WATER PUMP GASKET		1
53510930	R97454	INSPECTION COVER GASKET		1
53511030	R97455	OIL FILTER GASKET	1	1
53511130	R90648	OIL FILTER GASKET	1	1
53511330	T20328	COOLER GASKET		1
53511430		ERGONOMIC VALVE GASKET	1	2
83500840		KIT WASHERS AND RUBBERS	1	1
53511830		WATER PUMP GASKET		1
53511540		THERMOSTATIC GASKET	1	1

● SOLD SEPARATELY

APPLICATION



IVECO DAILY IV/DAILY IV COMBI 2007/...

FIAT DUCATO JTD 2006/...DUCATO/DUCATO COMBI 2010/...

CITROEN JUMPER III HDI 2008/...

PEUGEOT BOXER 3 HDI 2006/...MANAGER HDI 2010/...

MT F1CE0481D FIAT DUCATO 3.0 16VÁLUVULAS

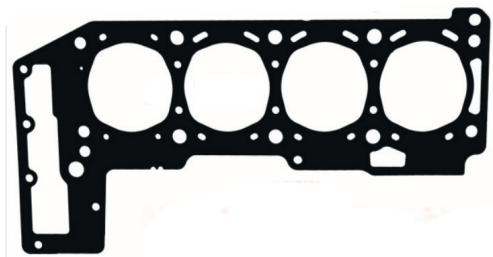

53501302



53509930

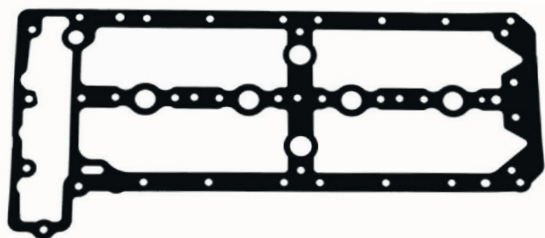

53509740



53509847

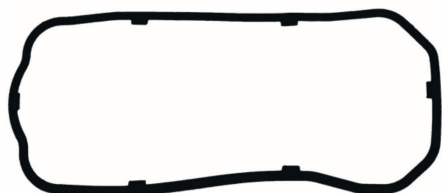

53509640

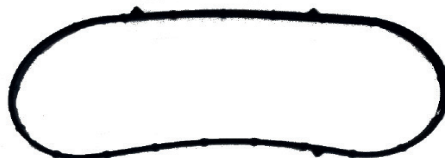

53511540

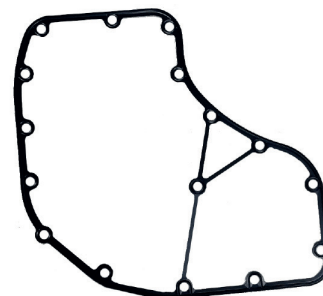

53510430



53510830



53511130



53511830



53510930



53510730



53511030



53511330



53510547



53510630



53510547



535511430



53510330



53509347



RE09093T



RE09092T



RE09088F

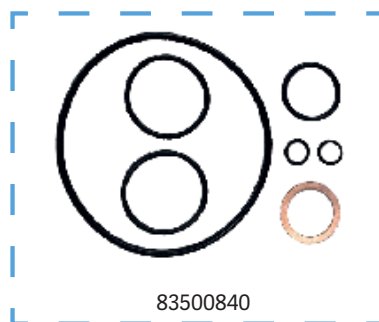

83500840

ENGINE IVECO CURSOR 8

N° SET		DESCRIPTION		
73510202		FULL GASKET SET IVECO CURSOR 8 WITH OIL SEAL	1	
73530202		HEAD GASKET SET IVECO CURSOR 8 WITH OIL SEAL	2	
N° ABR	N° ORIGINAL	DESCRIPTION		
53516702	504385500	CYLINDER HEAD GASKET	1	1
RE09126	40101573	VALVE STEM SEAL	24	24
53512440	99446692	VALVE COVER GASKET	1	1
53515640	504200838	OIL PAN GASKET		1
RE09131T	504042683	REAR CRANKSHAFT OIL SEAL		1
RE09132T	504042684	FRONT CRANKSHAFT OIL SEAL		1
53515030	504045791	FRONT COVER GASKET	1	1
53514404	500383043	OIL FILTER BREATHER GASKET		2
53512130	98451118	TURBOCHARGING GASKET		1
53516530	504375264	INTAKE MANIFOLD GASKET	2	2
53516647	504380076	EXHAUST MANIFOLD GASKET	6	6
53515367	504149689	OIL PUMP TUBE GASKET		1
53517230	500364380	SUCTION TUBE GASKET		1
53517330	500364892	SUCTION TUBE GASKET		2
53514830	504045785	THERMOSTATIC GASKET	1	1
53512730	98497873	OIL FILTER BREATHER GASKET		1
53513940	500383038	FRONT COVER GASKET		1
53514930	504045790	BLOCK COVER GASKET	1	1
53512530	99447382	REAR COVER GASKET		1
53513130	9944779999	WATER TUBE GASKET		1
53513630	500364603	WATER PUMP CONNECTION GASKET		1
53514730	504015752	HEAD OIL FILTER GASKET		1
53512330	99442502	HEAD OIL FILTER GASKET		1
53512067	504360820	INLET TURBO GASKET		2
RE09134T	504045790	THERMOSTAT SEAL		1
83500940		KIT RUBBERS		1
83501040		HEAD KIT RUBBERS	1	1
83501426		KIT WASHERSS		1

• SOLD SEPARATELY

APPLICATION



IVECO FPT F2B CURSOR 8 6 CYL 7.8L EURO 5

IVECO TRUCK EURO CARGO CAVALLINO 450E32 2007/12 180E32 2006/...

ENGINE IVECO CURSOR 8

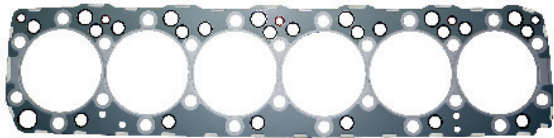

53516702



53515640

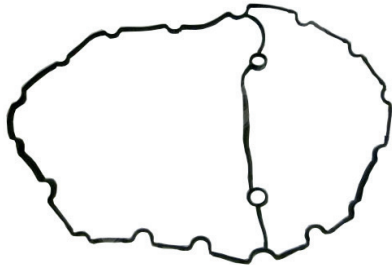

53513940

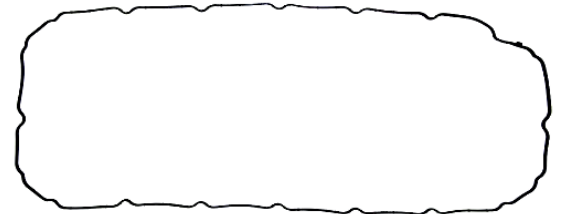

53512440



53512330



53514730



53514930

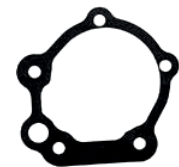

53515030

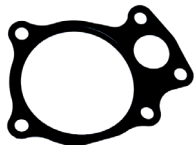

53514830



53513130

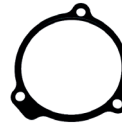

53512530



53513630



53512130



53516647



53516530

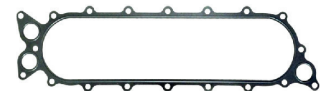

53512730



53515367



53517230



53517330



53512067



RE09132T



RE09134T



RE09131T



RE09126

N° SET		DESCRIPTION		
73510252		FULL GASKET SET IVECO CURSOR 9 WITH OIL SEAL	1	
73530252		HEAD GASKET SET IVECO CURSOR 9 WITH OIL SEAL	2	
N° ABR	N° ORIGINAL	DESCRIPTION		
53516702	504385500	CYLINDER HEAD GASKET	1	1
53516702	504366703	VALVE STEM SEAL	24	24
53512440	99446692	VALVE COVER GASKET	1	1
53516440	504346309	OIL PAN GASKET		1
RE09130T	40102693	REAR CRANKSHAFT OIL SEAL		1
RE09132T	504042684	FRONT CRANKSHAFT OIL SEAL		1
53516230	504314384	OIL LEVEL GASKET		1
53516130	504312666	BRAKE ENGINE GASKET		1
53515230	504147366	OIL FILTER GASKET		1
53517040	336432A1	OIL SEPARATOR FILTER GASKET		1
53512130	98451118	TURBOCHARGING GASKET		1
53516530	504375264	INTAKE MANIFOLD GASKET	2	2
53516647	504380076	EXHASUT MANIFOLD GASKET	6	6
53515367	504149689	OIL PUMP TUBE GASKET		1
53516330	504331011	TURBO INLET GASKET		1
53512067	504360820	INLET TURBO GASKET		1
53514830	504045785	THERMOSTATIC GASKET	1	1
53514930	504054790	BLOCK COVER GASKET	1	1
53515130	504128027	OIL COOLER GASKET		1
RE09134T	98494952	THERMOSTAT SEAL		1
53512530	99447382	REAR COVER GASKET		1
53516830	5801596032	HIGH PRESSURE PUMP GASKET		1
83500940		KIT RUBBER		1
83501040		HEAD KIT RUBBER	1	1
83501426		KIT WASHERS		1

• SOLD SEPARATELY

APPLICATION



IVECO FPT F2C CURSOR 9 6 CYL 8.7L EURO 5

IVECO TRUCK CURSOR 450E33 2009/12 STRALLIS 450S33/500S33 2013/15 460S36 2012/...530S36 2013/15

NEW HOLLAND TRACTOR T8270/T8295/T8325/T8355/T8385 2011/...COMBINE CR9060 2010/16 CR6.80 EVO/CR7.80 EVO 2017/...

CASE TRACTOR STEIGER 370 2012/...MAGNUM 235/240/260/270/290/315 2006/...340/380 2011/...

CASE COMBINE AF7120 2010/14 AF6130/AF7130 2016/...AF7230 2013/...A8000/A8800 2009/...

IVECO CURSOR 9

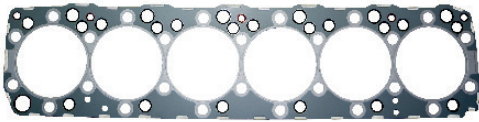

53516702



53515130

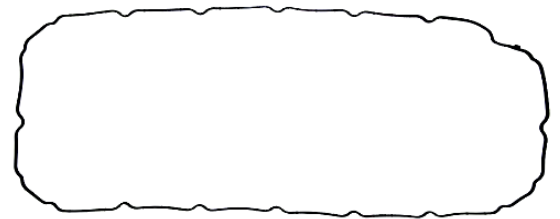

53512440



53516440

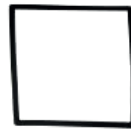

53517040



53516130



53515367



53516230



53516330



53512067



53516830



53516447



53512130



53516530



53514830



53514830



53512530



5351230



RE09130T



RE09132T



RE09134T



RE09133F

ENGINE IVECO CURSOR

N° SET		10 DESCRIPTION		
73510352	FULL GASKET SET IVECO CURSOR 10 WITH OIL SEAL			1
73530352	HEAD GASKET SET IVECO CURSOR 10 WITH OIL SEAL			2
N° ABR	N° ORIGINAL	DESCRIPTION		
53515740	504262851	OIL PAN GASKET		1
RE09130T	40102693	REAR CRANKSHAFT OIL SEAL		1
53512630	99448739	THERMOSTATIC GASKET		1
RE09129T	40102683	FRONT CRANKSHAFT OIL SEAL		1
53513840	500382999	FRONT COVER GASKET		1
53513940	500383038	FRONT COVER GASKET		1
53514147	500383189	REAR COVER GASKET		1
53514540	500398649	OIL FILTER BREATHER GASKET		1
53514040	500383043	OIL FILTER BREATHER GASKET		2
53514402	500396535	CYLINDER HEAD GASKET		1
RE09127F	40101584	VALVE STEM SEAL		24
53513340	500323989	VALVE COVER GASKET		1
53515547	504154279	EXHAUST MANIFOLD GASKET		6
53513730	500370033	THERMOSTATIC GASKET		1
53516530	504375264	INTAKE MANIFOLD GASKET		2
53512130	98451118	TURBOCHARGING GASKET		1
53513030	99475979	TURBO INLET GASKET		1
53512830	99452273	OIL PUMP CONNECTION GASKET		1
53514730	504015752	HEAD OIL FILTER GASKET		1
53513430	500343518	OIL PUMP TUBE GASKET		1
53512730	98497873	OIL COOLER GASKET		1
53512930	99466940	WATER TUBE GASKET		1
53513530	500362150	THERMOSTATIC GASKET		1
53512530	99447382	OIL PUMP GASKET		1
RE09134T	98494952	THERMOSTAT SEAL		2
53515367	504149689	OIL PUMP TUBE GASKET		1
83501140		KIT RUBBERS		1
83501240		HEAD KIT RUBBERS		1
83501626		KIT WASHERS		1

• SOLD SEPARATELY

APPLICATION



IVECO FPT F3A CURSOR 10 6 CYL 10.3L EURO 5

FORD TRUCK CARGO 2042E/2842E 2013/...

NEW HOLLAND COMBINE CR7.90 EVO 2017/...

CASE COMBINE 8120 2010/15

ENGINE IVECO CURSOR 10

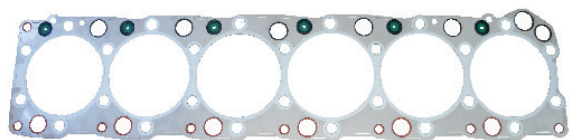

53514402

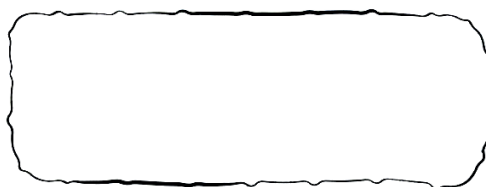

53513340

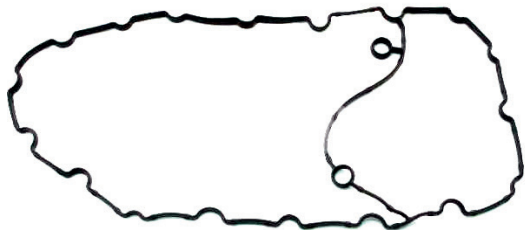

53513840

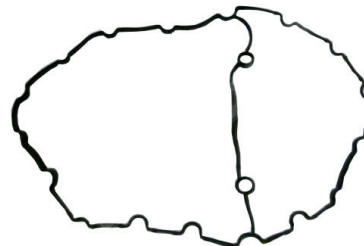

53513940



53514040

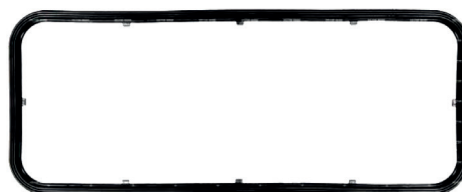

53515740



53512730



53514147



53514730

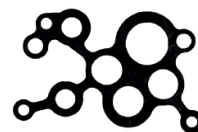

53512830



53513530



53513730



53512130



53516530



53512930



53512530



53512630



53514540



53515367



53513030



53513430



53515547



RE09129T



RE09130T



RE03134T



RE09129T

N° SET		13 DESCRIPTION		
73510302	FULL GASKET SET IVECO CURSOR 13 WITH OIL SEAL			1
73530302	HEAD GASKET SET IVECO CURSOR 13 WITH OIL SEAL			2
N° ABR	N° ORIGINAL	DESCRIPTION		
503814840	504024777	OIL PAN GASKET		1
RE09130T	40102693	REAR CRANKSHAFT OIL SEAL		1
53512630	99448739	THERMOSTATIC GASKET		1 1
RE09129T	40102683	FRONT CRANKSHAFT OIL SEAL		1
53513840	500382999	FRONT COVER GASKET		1
53514147	500383189	REAR COVER GASKET		1
53514540	500398649	OIL FILTER BREATHER GASKET		1
53514040	500383043	OIL FILTER BREATHER GASKET		2
53514602	504007514	CYLINDER HEAD GASKET		1 1
RE09128F	40101874	VALVE STEM SEAL		24 24
53513240	500309014	VALVE COVER GASKET		1 1
53515447	504154280	EXHAUST MANIFOLD GASKET		6 6
53513730	500370033	THERMOSTATIC GASKET		1 1
53516530	504375264	INTAKE MANIFOLD GASKET		2 3
53512230	98453300	TURBOCHARGING GASKET		1
53514230	500387050	TURBOCHARGING GASKET		1
53511967	61318303	TURBO INLET GASKET		1
53513030	99475979	TURBO INLET GASKET		1
53512830	99452273	OIL PUMP CONNECTION GASKET		1
53514330	500387958	OIL PUMP CONNECTION GASKET		1
53514730	504015752	HEAD OIL FILTER GASKET		1
53513430	500343518	OIL PUMP TUBE GASKET		1
53517130	500388968	OIL PUMP CONNECTION GASKET		1
53512730	98497873	OIL COOLER GASKET		1
53512930	9946640	WATER TUBE GASKET		1
53513530	500362150	THERMOSTATIC GASKET		1 1
53512530	99447382	OIL PUMP GASKET		1
RE09134T	98494952	THERMOSTAT SEAL		2
53515367	504149689	OIL PUMP TUBE GASKET		1
53512067	504360820	INLET TURBO GASKET		1
83501340		KIT RUBBERS		1
83501240		HEAD KIT RUBBERS		1 1
83501526		KIT WASHERS		1

● SOLD SEPARATELY

ENGINE IVECO CURSOR 13

APPLICATION



IVECO FPT F3B CURSOR 13 6 CYL 12.9L EURO 5

IVECO TRUCK EUROTECH 740E42 2002/06 TRACKER 380T38 2008/11 380T42/720T42 2008/12 410T48/740T48 2013/17

STRALLIS 450S38 2005/09 490S38 2008/12 570S38 2006/12 490S40 2012/...600S40 2013/...490S41/570S41/740S41 2010/12

450S42 2006/07 490S42 2008/10 570S42 2006/10 740S42 2006/10 490S44/600S44/800S44 2013/...490S46/570S46/740S46 2010/12

490S48T 2013/15 600S48/800S48 2013/...600S56 2013/15 800S/56 2013/...EUROTRAKKER 380E38 2004/09 720E42 2004/09

NEW HOLLAND TRACTOR T9480/T9530/T9560/T9600/T9700 2012/...COMBINE CR8090 2011/17 CR9090 2013/16

CR9080 2011/16 CR8.90 EVO 2017/...

CASE TRACTOR STEIGER 420/470/500/540/550/580/620 2012/...COMBINE AF8230/9230 2013/...

ENGINE IVECO CURSOR 13



53514602

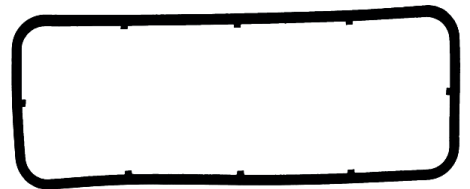

53514840

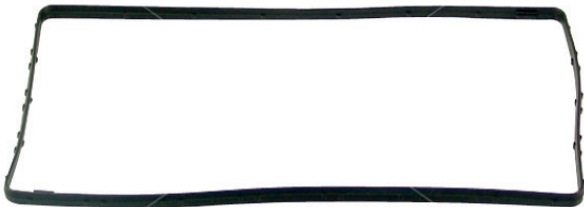

53514040

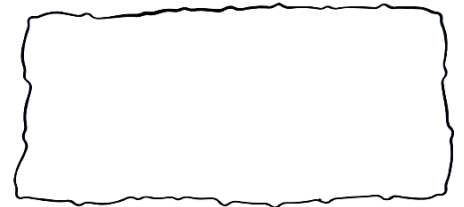

50918655

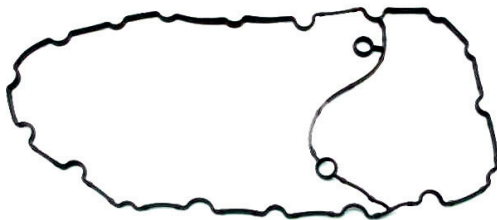

53514147



53514540



53514730



53512830



53514330



53513530



53512230



53512230



53513730



53512630

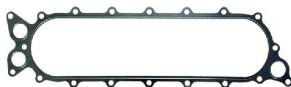

53512730



53513840



53512530



53514230

ENGINE IVECO CURSOR 13



53515367



53513030



53511967



53512067



53513430



53517130



53512930



53515447



RE09129T



RE09130T



RE09134T



RE09128F

The Scania logo is centered on a white page. It features two parallel blue diagonal slashes on the left, followed by the word "SCANIA" in a bold, blue, sans-serif font. The entire logo is enclosed within a thin blue rectangular border that has a small gap at the top and bottom center.

//SCANIA

SCANIA

N° ABR	ENGINE	DESCRIPTION	PAGE
73716300	DN11/DS11	FULL GASKET SET WITH OIL SEAL WITH LINER RINGS	204
63714745	DN11/DS11	FULL GASKET SET WITHOUT OIL SEAL WITHOUT LINER RINGS	204
73714745	DN11/DS11	FULL GASKET SET WITH OIL SEAL WITH LINER RINGS	204
63734745	DN11/DS11	HEAD GASKET SET WITHOUT OIL SEAL WITHOUT LINER RINGS	204
73796310	DS11/DSC11	FULL GASKET SET WITHOUT OIL SEAL WITHOUT LINER RINGS	208
63796315	DS11/DSC11	FULL GASKET SET WITH OIL SEAL WITHOUT LINER RINGS	208
73796315	DS11/DSC11	HEAD GASKET SET WITH OIL SEAL WITH LINER RINGS	208
63736345	DS11/DSC11	HEAD GASKET SET WITHOUT OIL SEAL WITHOUT LINER RINGS	208
73710430	DN11/DS11/DSC11	FULL GASKET SET WITH OIL SEAL WITH LINER RINGS	212
63710435	DN11/DS11/DSC11	FULL GASKET SET WITHOUT OIL SEAL WITHOUT LINER RINGS	212
73710435	DN11/DS11/DSC11	FULL GASKET SET WITH OIL SEAL WITHOUT LINER RINGS	216
63730435	DN11/DS11/DSC11	HEAD GASKET SET WITHOUT OIL SEAL WITHOUT LINER RINGS	216
63710129	DC11	FULL GASKET SET WITHOUT OIL SEAL WITH LINER RINGS	220
73710129	DC11	FULL GASKET SET WITH OIL SEAL WITH LINER RINGS	220
63710429	DSC12	FULL GASKET SET WITHOUT OIL SEAL WITH LINER RINGS	220
73710429	DSC12	FULL GASKET SET WITH OIL SEAL WITH LINER RINGS	220
63710109	DSC12	FULL GASKET SET WITHOUT OIL SEAL WITH LINER RINGS	220
73710109	DSC12	FULL GASKET SET WITH OIL SEAL WITH LINER RINGS	220
63730121	DC11	MONOCYLINDER GASKET SET WITHOUT OIL SEAL WITHOUT LINER RINGS	224
73730121	DC11	MONOCYLINDER GASKET SET WITH OIL SEAL WITHOUT LINER RINGS	224
63730421	DSC12	MONOCYLINDER GASKET SET WITHOUT OIL SEAL WITHOUT LINER RINGS	224
73730421	DSC12	MONOCYLINDER GASKET SET WITH OIL SEAL WITHOUT LINER RINGS	224
63730101	DSC12	MONOCYLINDER GASKET SET WITHOUT OIL SEAL WITHOUT LINER RINGS	224
73730101	DSC12	MONOCYLINDER GASKET SET WITH OIL SEAL WITHOUT LINER RINGS	224
73712535	DS14/LK140/LK141	FULL GASKET SET WITH OIL SEAL WITHOUT LINER RINGS	226
63732535	DS14/LK140/LK141	MONOCYLINDER GASKET SET WITHOUT OIL SEAL WITHOUT LINER RINGS	226

DN11/DS11 6 CYLINDERS 11 LITERS (SERIE 2)

N° SET		DESCRIPTION				
73716300		FULL GASKET SET DN11 / DS11 WITH OIL SEAL WITH LINER RINGS	1			
63714745		FULL GASKET SET DN11 / DS11 WITHOUT OIL SEAL WITHOUT LINER RINGS	2			
73714745		FULL GASKET SET DN11 / DS11 WITH OIL SEAL WITHOUT LINER RINGS	3			
63734745		FULL GASKET SET DN11 / DS11 WITHOUT OIL SEAL WITHOUT LINER RINGS	4			
N° ABR	N° ORIGINAL	DESCRIPTION				
53702867	35161	WATER PIPE GASKET	1	1	1	1
53702967	35309	BREATHER GASKET	1	1	1	1
53704850	131103	VALVE COVER GASKET	2	2	2	2
53704990	131131	CYLINDER HEAD HOSE GASKET	1	1	1	1
53705090	131133	THERMOSTAT GASKET	2	2	2	2
53705167	131166	SLIDE COVER GASKET	2	2	2	2
53705267	287554	REAR COVER GASKET	1	1	1	1
53705667	139274	COVER HOUSING GASKET	1	1	1	1
53705790	277632	INTAKE MANIFOLD GASKET	2	2	2	2
53706567	287555	FLYWHEEL COVER GASKET	1	1	1	1
53706667	139044	THERMOSTAT GASKET	1	1	1	1
53706867	277637	OIL FILTER GASKET	1	1	1	1
53706985	139123	ROCKER SUPPORT GASKET	6	6	6	6
53707090	139144	TIMING COVER GASKET	1	1	1	1
53707165	139146	FRONT CRANKSHAFT GASKET	1	1	1	1
53707265	139149	REAR CRANKSHAFT GASKET	1	1	1	1
53707567	1675602	TIMING COVER GASKET	1	1	1	1
53708667	162142	PULLEY BEARING FIXATION GASKET	1	1	1	1
53709490	2155242	OIL PAN GASKET	1	1	1	1
53709770	238775	OIL PUMP GASKET	1	1	1	1
53710030		FLTWHEEL SMALL GASKET	3	3	3	3
53710130		CONNECTING ROD GASKET	1	1	1	1
53710630		FLYWHEEL GASKET	1	1	1	1
53710967	131236	WATER PUMP GASKET	1	1	1	1
53714867	170765	OIL FILTER GASKET	1	1	1	1
53715067	232961	OIL FILTER GASKET	1	1	1	1
53715117	131294	EXHAUST MANIFOLD GASKET	2	2	2	2
53715217	131295	EXHAUST MANIFOLD GASKET	2	2	2	2
53715367	235610	OIL SEAL GASKET	1	1	1	1
53715467	238148	THERMOSTAT COVER GASKET	1	1	1	1
53715567	283403	OIL FILTER GASKET ÓLEO	1	1	1	1
53717467	238309	OIL FILTER GASKET	1	1	1	1
53717667	272793	SLIDE COVER GASKET DO CARTER				
53723616	1109288	EXHAUST MANIFOLD GASKET		2		
53723716	378264	EXHAUST MANIFOLD GASKET		2		
53725105	373472	CYLINDER HEAD GASKET	2	2	2	2
53725267	292759	INLET WATER TUBE GASKET	1	1	1	1
53725790	1675584	INTAKE MANIFOLD GASKET				
53725890	1675583	INTAKE MANIFOLD GASKET				
53725967	295050	THERMOSTAT GASKET				
53726067		OIL SEAL GASKET				
53726167	371238	WITHPRESSOR GASKET	1	1	1	1
53726267	338332	INTAKE MANIFOLD GASKET				
53726367	277633	SLIDE COVER GASKET				
53726467	287334	THERMOSTAT GASKET				
53726567	287559	ENGINE BREATHER GASKET				
53726667		OIL SEAL GASKET				
53726767		OIL SEAL GASKET	1	1	1	1
53729245		LINER RING GASKET	18			18
53754440	1302828	LINER SHIM GASKET				
83727526		HEAD KIT WASHERS				
83727629		KIT WASHERS	1	1	1	1
83727741		KIT RUBBERS	1	1	1	1
RE02069S		REAR OIL SEAL	1	1		1
RE02235S		FRONT OIL SEAL	1	1		1

• SOLD SEPARATELY

DN11/DS11 6 CYLINDERS 11 LITERS (SERIE 2)

APPLICATION

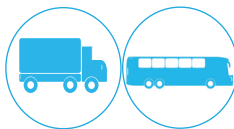

SCANIA DN11/DS11 6 CYL 11L(SERIES 2)

SCANIA TRUCK 112H 1982/86 ; 112HS 1987/89 ; 112HW 1989/91

SCANIA BUS S112/K112 1983/91

SCANIA DS11/DSC11 6 CYL 11L(SERIES 3)

SCANIA TRUCK R113E/R113H 1991/98 ; T113E/T113H 1991/98

SCANIA BUS S113 1991/93 ; L113 1993/98 ; K113 1994/98

DN11/DS11 6 CYLINDERS 11 LITERS (SERIES 2)

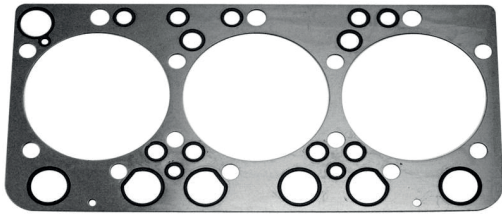

54725105

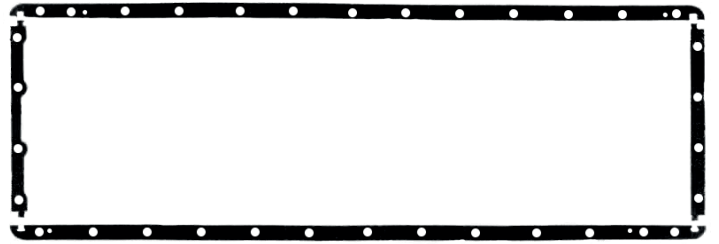

53709490

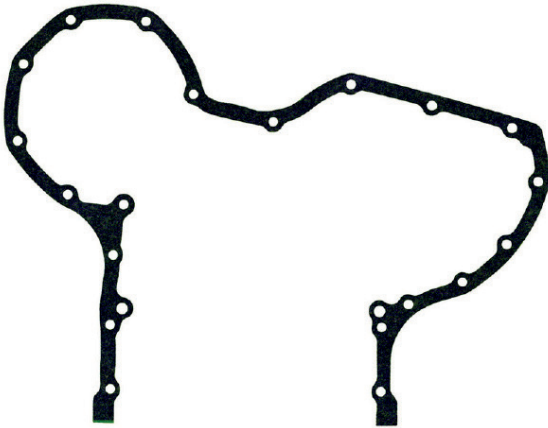

53707567

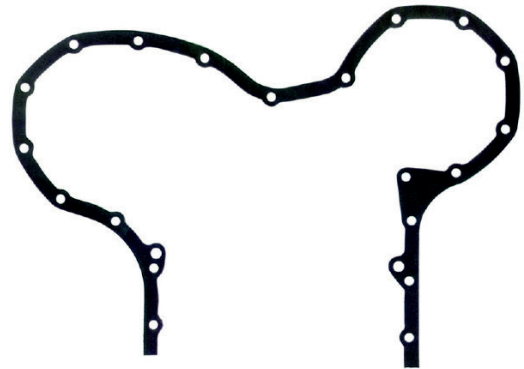

53707090

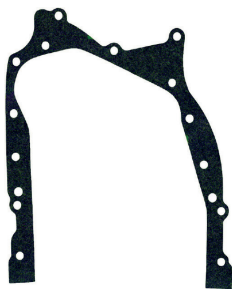

53705267



53706567

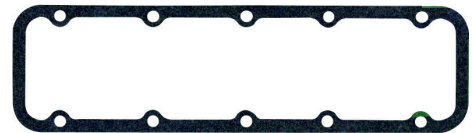

53704850



53705167



53704850



53715567



53705090



53710030



53710130



53710630



53725790

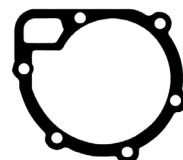

53710967

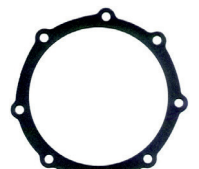

53708667



RE02235S



53707165



RE02069S



53707265

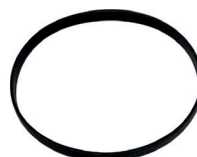

53754440

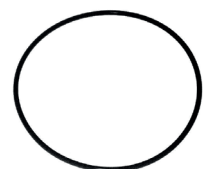

53729245

DN11/DS11 6 CYLINDERS 11 LITERS (SERIE 2)

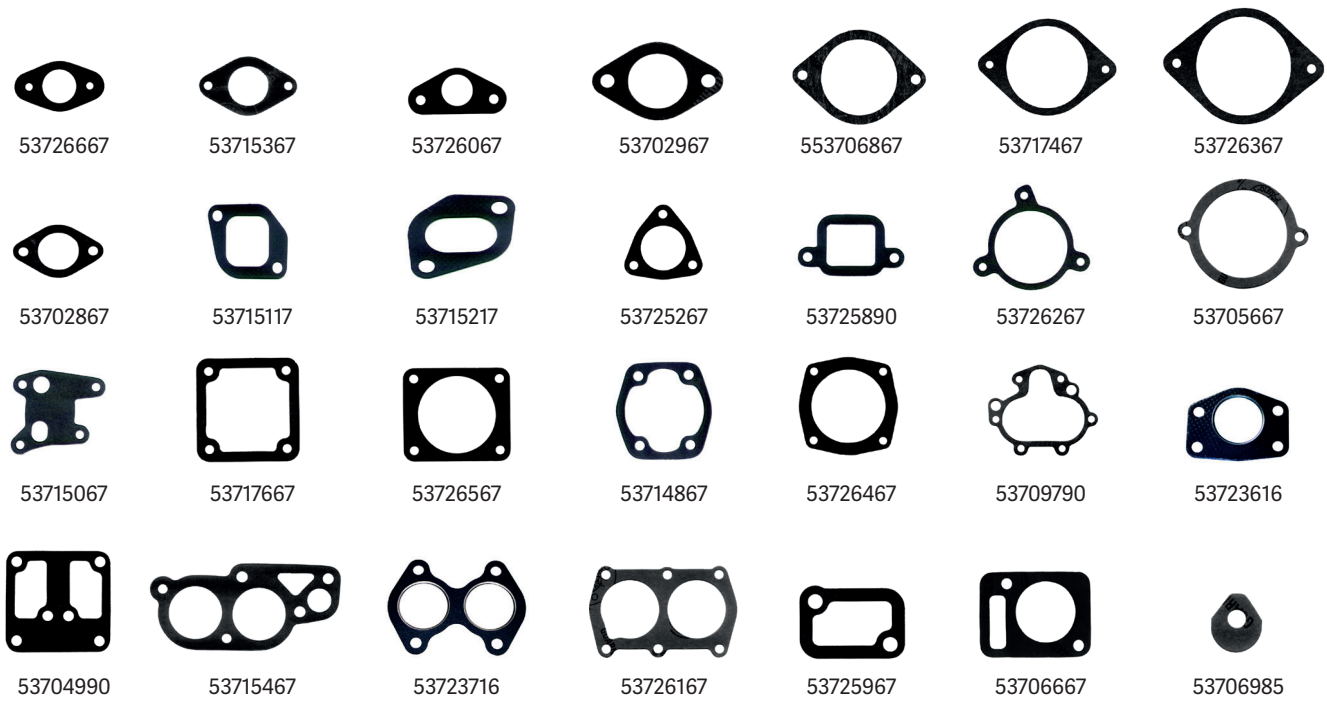

83727741 KIT RUBBERS		
N° ABR	DESCRIPTION	QTD
50028141	SEAL 106,7 X 3,5 MM	1
50027941	SEAL 106,5 X 2,1 MM	1
50005741	SEAL 20,0 X 4,0 MM	3
50010941	SEAL 26,0 X 3,2 MM	2
50009141	SEAL 59,0 X 3,4 MM	1
50028841	SEAL 126,0 X 5,0 MM	1
50029141	SEAL 135,0 X 2,8 MM	2
50030741	SEAL 43,5,0 X 3,4 MM	2
50031441	SEAL 53,0 X 3,3 MM	2
50034241	SEAL 10,2 X 3,2 MM	1
50035841	SEAL 41,5 X 56,3 X 3,5 MM	1
50036941	SEAL 13,0 X 2,5 MM	2
50039641	SEAL 16,0 X 2,4 MM	1
50040541	SEAL 19,0 X 3,2 MM	3
50054541	SEAL 34,5 X 46,0 X 2,5 MM	1
50055141	SEAL 18,0 X 29,0 X 4,3 MM	4
50026841	SEAL 74,2 X 3,5 MM	2
53702441	THERMOSTATIC SEAL	1
53751041	VALVE COVER SEAL	4

83727629 KIT WASHERS		
N° ABR	DESCRIPTION	QTD
50011323	COPPER WASHER 8,3 X 13,8 X 1,0 MM	1
50083330	STEEL WASHER 9,5 X 20,0 X 2,0 MM	6
50021229	ALUMINUM WASHER 14,0 X 20,0 X 1,5 MM	10
50018529	ALUMINUM WASHER 12,0 X 16,0 X 1,5 MM	8
50012223	COPPER WASHER 8,0 X 12,0 X 1,0 MM	14
50071228	ALUMINUM WASHER 26,4 X 33,7 X 1,0 MM	1
50025829	ALUMINUM WASHER 18,0 X 24,0 X 1,0 MM	1
50015528	ALUMINUM WASHER 10,0 X 16,0 X 1,0 MM	12
	COPPER WASHER 10,2 X 21,3 X 1,8 MM	6
50015429	ALUMINUM WASHER 10,0 X 14,0 X 1,5 MM	4
50026728	ALUMINUM WASHER 20,0 X 26,0 X 1,0 MM	2

83727526 HEAD KIT WASHER		
N° ABR	DESCRIPTION	QTD
50014123	COPPER WASHER 9,5 X 20,0 X 1,0 MM	6
50002129	ALUMINUM WASHER 14,0 X 20,0 X 1,5 MM	4
50018529	ALUMINUM WASHER 12,0 X 16,0 X 1,5 MM	8
50012223	COPPER WASHER 8,0 X 12,0 X 1,0 MM	14

DS11/DSC11 6 CYLINDERS 11 LITERS (SERIE 3)

N° SET			
73796310	FULL GASKET SET DS11/DSC11 WITHOUT OIL SEAL WITHOUT LINER RINGS		1
63796315	FULL GASKET SET DS11/DSC11 WITH OIL SEAL WITHOUT LINER RINGS		2
73796315	HEAD GASKET SET DS11/DSC11 WITH OIL SEAL WITH LINER RINGS		3
63736345	HEAD GASKET SET DS11/DSC11 WITHOUT OIL SEAL WITHOUT LINER RINGS		4
N° ABR	N° ORIGINAL	DESCRIPTION	
53702867	35161	WATER PIPE GASKET	1 1 1 1
53702967	35309	BREATHER GASKET	1 1 1 1
53704850	131103	VALVE COVER GASKET	2 2 2 2
53704990	131131	CYLINDER HEAD GASKET	1 1 1 1
53705090	131133	THERMOSTAT GASKET	2 2 2 2
53705167	131166	SLIDE COVER GASKET	2 2 2 2
53705267	287554	REAR COVER GASKET	1 1 1 1
53705667	139274	COVER HOUSING GASKET	1 1 1 1
53705790	277632	INTAKE MANIFOLD GASKET	2 2 2 2
53706567	287555	FLYWHEEL COVER GASKET	1 1 1 1
53706667	139044	THERMOSTAT GASKET	1 1
53706867	277637	OIL FILTER GASKET	1 1 1 1
53706985	139123	ROCKER SUPPORT GASKET	6 6 6 6
53707090	139144	TIMING COVER GASKET	1 1
53707165	139146	FRONT CRANKSHAFT GASKET	1 1 1 1
53707265	139149	REAR CRANKSHAFT OIL SEAL	1 1 1 1
53707567	1675602	TIMING COVER GASKET	1 1 1 1
53708667	162142	DISTRIBUTION COVER GASKET	1 1 1 1
53709490	2155242	OIL PAN GASKET	1 1 1 1
53709770	238775	OIL PUMP GASKET	1 1 1 1
53710030		FLYWHEEL GASKET (SMALL)	3 3 3 3
53710130		CONNECTING ROD GASKET	1 1 1 1
53710630		FLYWHEEL GASKET	1 1 1 1
53710967	131236	WATERPUMP GASKET	1 1 1 1
53714867	170765	OIL FILTER GASKET	1 1 1 1
53715067	232961	OIL FILTER GASKET	1 1 1 1
53715117	131294	EXHAUST MANIFOLD GASKET	2 2
53715217	131295	EXHAUST MANIFOLD GASKET	2 2
53715367	235610	OIL SEAL GASKET	1 1 1 1
53715467	238148	THERMOSTAT COVER GASKET	1 1
53715567	283403	OIL FILTER GASKET	1 1 1 1
53717467	238309	OIL FILTER GASKET	1 1 1 1
53717667	272793	SLIDE COVER GASKET	1 1
53723616	1109288	EXHAUST MANIFOLD GASKET	2 2 2
53723716	378264	EXHAUST MANIFOLD GASKET	2 2 2
53725105	373472	CYLINDER HEAD GASKET	2 2 2 2
53725267	292759	INLET TUBE WATER GASKET	1 1 1 1
53725790	1675584	INTAKE MANIFOLD GASKET	2 2
53725890	1675583	INTAKE MANIFOLD GASKET	4 4
53725967	295050	THERMOSTAT GASKET	1 1
53726067		OIL SEAL GASKET	2 2
53726167	371238	WITHPRESSOR GASKET	1 1 1 1
53726267	338332	INTAKE MANIFOLD GASKET	1 1
53726367	277633	SLIDE COVER GASKET	1 1
53726467	287334	THERMOSTAT GASKET	1 1
53726567	287559	ENGINE BREATHER GASKET	1 1
53726667		OIL SEAL GASKET	1 1
53726767		OIL SEAL GASKET	1 1 1 1
53729245		LINER RING GASKET	12 12
53754440	1302828	LINER SHIM GASKET	6 6
83727526		HEAD KIT WASHERS	
83727629		KIT WASHERS	1 1 1 1
83727741		KIT RUBBERS	1 1 1 1
RE02069S		REAR OIL SEAL	1 1 1
RE02235S		FRONT OIL SEAL	1 1 1

• SOLD SEPARATELY

DS11/DSC11 6 CYLINDERS 11 LITERS (SERIE 3)

APPLICATION

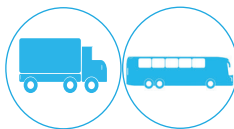

SCANIA DN11/DS11 6 CYL 11L(SERIE 2)

SCANIA TRUCK 112H 1982/86 ; 112HS 1987/89 ; 112HW 1989/91

SCANIA BUS S112/K112 1983/91

SCANIA DS11/DSC11 6 CYL 11L(SERIE 3)

SCANIA TRUCK R113E/R113H 1991/98 ; T113E/T113H 1991/98

SCANIA BUS S113 1991/93 ; L113 1993/98 ; K113 1994/98

DS11/DSC11 6 CYLINDERS 11 LITERS (SERIE 3)

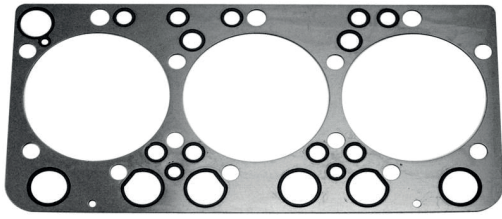

54725105

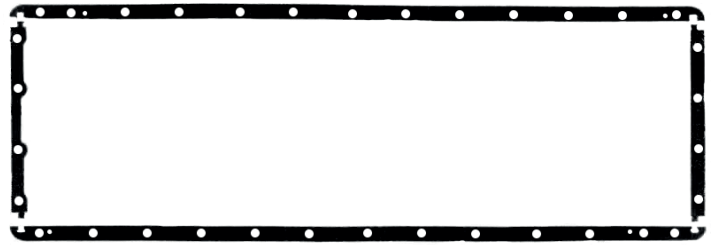

53709490

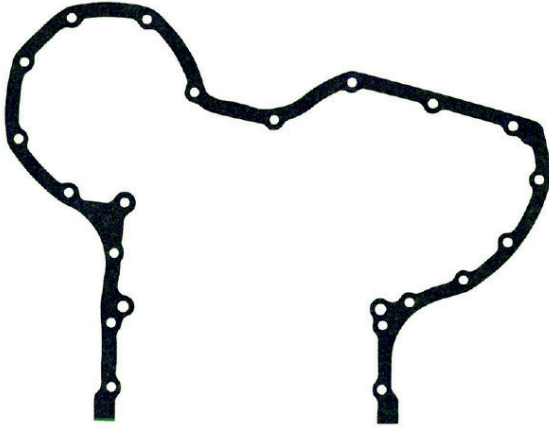

53707567

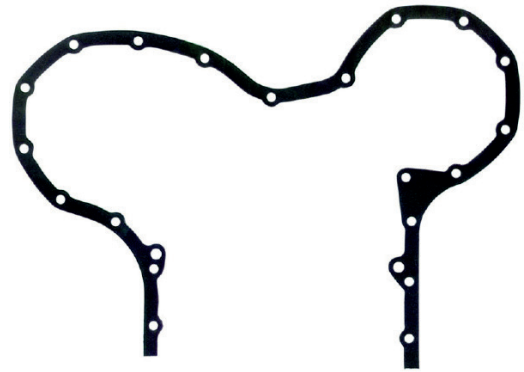

53707090

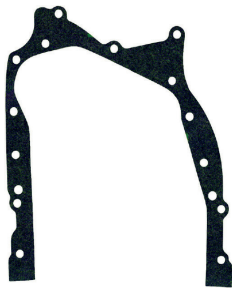

53705267



53706567

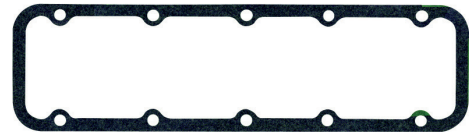

53704850

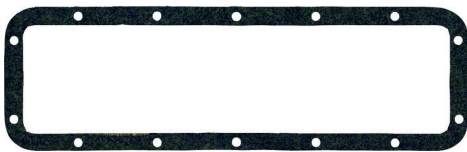

53705167

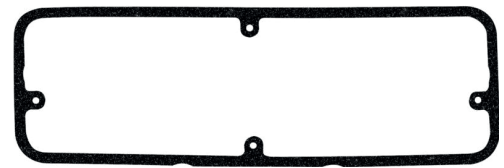

53704850

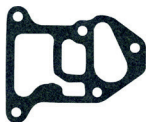

53715567



53705090



53710030



53710130



53710630



53725790

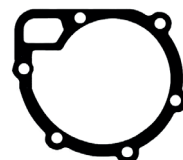

53710967

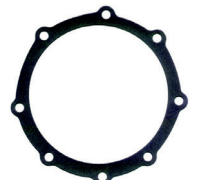

53708667



RE02235S



53707165



RE02069S

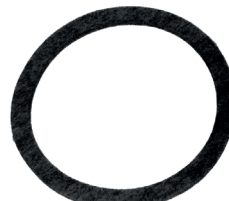

53707265

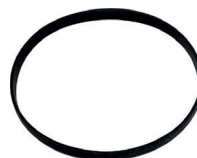

53754440

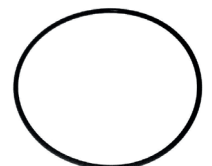

53729245

DS11/DSC11 6 CYLINDERS 11 LITERS (SERIE 3)



83727741 KIT RUBBERS			
N° ABR	DESCRIPTION	QTD	
50028141	SEAL 106,7 X 3,5 MM	1	
50027941	SEAL 106,5 X 2,1 MM	1	
50005741	SEAL 20,0 X 4,0 MM	3	
50010941	SEAL 26,0 X 3,2 MM	2	
50009141	SEAL 59,0 X 3,4 MM	1	
50028841	SEAL 126,0 X 5,0 MM	1	
50029141	SEAL 135,0 X 2,8 MM	2	
50030741	SEAL 43,5,0 X 3,4 MM	2	
50031441	SEAL 53,0 X 3,3 MM	2	
50034241	SEAL 10,2 X 3,2 MM	1	
50035841	SEAL 41,5 X 56,3 X 3,5 MM	1	
50036941	SEAL 13,0 X 2,5 MM	2	
50039641	SEAL 16,0 X 2,4 MM	1	
50040541	SEAL 19,0 X 3,2 MM	3	
50054541	SEAL 34,5 X 46,0 X 2,5 MM	1	
50055141	SEAL 18,0 X 29,0 X 4,3 MM	4	
50026841	SEAL 74,2 X 3,5 MM	2	
53702441	THERMATATIC SEAL	1	
53751041	VALVE COVER SEAL	4	

83727629 KIT WASHERS			
N° ABR	DESCRIPTION	QTD	
50011323	COPPER WASHER 8,3 X 13,8 X 1,0 MM	1	
50083330	STEEL WASHER 9,5 X 20,0 X 2,0 MM	6	
50021229	ALUMINUM WASHER 14,0 X 20,0 X 1,5 MM	10	
50018529	ALUMINUM WASHER 12,0 X 16,0 X 1,5 MM	8	
50012223	COPPER WASHER 8,0 X 12,0 X 1,0 MM	14	
50071228	ALUMINUM WASHER 26,4 X 33,7 X 1,0 MM	1	
50025829	ALUMINUM WASHER 18,0 X 24,0 X 1,0 MM	1	
50015528	ALUMINUM WASHER 10,0 X 16,0 X 1,0 MM	12	
	COPPER WASHER 10,2 X 21,3 X 1,8 MM	6	
50015429	ALUMINUM WASHER 10,0 X 14,0 X 1,5 MM	4	
50026728	ALUMINUM WASHER 20,0 X 26,0 X 1,0 MM	2	

83727526 HEAD KIT WASHERS			
N° ABR	DESCRIPTION	QTD	
50014123	COPPER WASHER 9,5 X 20,0 X 1,0 MM	6	
50002129	ALUMINUM WASHER 14,0 X 20,0 X 1,5 MM	4	
50018529	ALUMINUM WASHER 12,0 X 16,0 X 1,5 MM	8	
50012223	COPPER WASHER 8,0 X 12,0 X 1,0 MM	14	

DN11/DS11/DSC11 6 CYLINDERS 24 VALVES 11 LITERS UNIFIED (SERIES 2 / 3)

N° SET		DESCRIPTION		
73710430		FULL GASKET SET DN11/DS11/DSC11 WITH OIL SEAL WITH LINER RINGS	1	
63710435		FULL GASKET SET DN11/DS11/DSC11 WITHOUT OIL SEAL WITHOUT LINER RINGS	2	
N° ABR	N° ORIGINAL	DESCRIPTION		
53725105	373472	CYLINDER HEAD GASKET Ø148MM	2	2
53704850	131103	VALVE COVER GASKET	2	2
53715117	131294	EXHAUST MANIFOLD GASKET	2	2
53715217	131295	EXHAUST MANIFOLD GASKET	2	2
53723616	1109288	EXHAUST MANIFOLD GASKET	2	2
53723716	378264	EXHAUST MANIFOLD GASKET	2	2
53725790	1675584	INTAKE MANIFOLD GASKET	2	2
53725890	1675583	INTAKE MANIFOLD GASKET	2	4
53705785	277632	INTAKE MANIFOLD GASKET	2	2
53709490	2155242	OIL PAN GASKET	1	1
53707085	139144	FRONT TIMING CASE COVER GASKET	1	1
53707598	1675602	FRONT TIMING CASE COVER GASKET	1	1
53706567	287555	FLYWHEEL COVER GASKET	1	1
53705267	287554	REAR TIMING CASE COVER GASKET	1	1
RE02069S		REAR CRANKSHAFT OIL SEAL 130X160X15MM		1
RE02235S		FRONT CRANKSHAFT OIL SEAL 80X100X12MM		1
52161231		ELBOW TURBOCHARGING GASKET	1	1
53702867	35161	WATER TUBE GASKET	1	1
53702967	35309	OIL BREATHER GASKET	1	1
53704990	131131	CYLINDER HEAD HOSE GASKET	1	1
53705090	131133	THERMOSTAT GASKET	2	2
53705167	131166	SLIDE COVER GASKET	2	2
53705667	139274	COVER HOUSING GASKET	1	1
53706667	139044	THERMOSTATIC COVER GASKET	1	1
53706867	277637	OIL FILTER GASKET	1	1
53706985	139123	ROCKER SUPPORT GASKET	6	6
53707165	139146	FRONT CRANKSHAFT GASKET	1	1
53707265	139149	REAR CRANKSHAFT GASKET	1	1
53707367	131305	INJECTOR PUMP GASKET	1	1
53708231		ELBOW TURBOCHARGING GASKET	1	1
53708667	162142	PULLEY BEARING FIXATION GASKET	1	1
53709770	238775	OIL PUMP GASKET	1	1
53710030	131043	CONNECTING ROD GASKET (SMALL)	3	3
53710130		CONNECTING ROD GASKET	1	1
53710630	139493	CONNECTING ROD GASKET (BIG)	1	1
53710967	131236	WATER PUMP GASKET	1	1
53711331		TURBOCHARGING GASKET	1	1
53714767		OIL SEAL GASKET	1	1
53714867	170765	OIL FILTER GASKET	1	1
53714967		OIL SEAL GASKET	1	1
53715067	232961	OIL RADIATOR GASKET	1	1
53715367	235610	OIL TUBE GASKET	1	1
53715467	238148	THERMOSTATIC COVER GASKET	1	1
53715567	283403	OIL FILTER GASKET	1	1
53715967		OIL TUBE GASKET	1	1
53717467	238309	HYDRAULIC PUMP GASKET	1	1
53717667	272793	OIL COVER GASKET	1	1
53720496	142972	WITHPRESSOR GASKET	1	1
53720767		INLET TURBOCHARGING GASKET	1	1
53725267	292759	INLET WATER TUBE GASKET	1	1
53725967	295050	THERMOSTAT GASKET	1	1
53726067	287559	BREATHER GASKET	2	2
53726167	271238	THERMOSTAT GASKET	1	1
53726267	338332	INTAKE MANIFOLD GASKET	1	1
53726367	277633	SLIDE CYLINDER COVER GASKET	1	1
53726467	287334	THERMOSTAT GASKET	1	1
53726567	287559	EXHAUST MANIFOLD GASKET	1	1
53726667		OIL SEAL GASKET	1	1
53726767		OIL SEAL GASKET	1	1
50029243		LINER RING		18
53754440	1302828	LINER SHIM		6
83727526		HEAD KIT WASHERS		
83727629		KIT WASHERS	1	1
83727741		KIT RUBBERS	1	1

● SOLD SEPARATELY

DN11/DS11/DSC11 6 CYLINDERS 24 VALVES 11 LITERS UNIFIED (SERIES 2 / 3)

APPLICATION

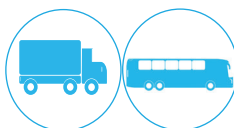

TRUCK 112H 1982/86 ; 112HS 1987/89 ; 112HW 1989/91 ; R113E/R113H 1991/98 ; T113E/T113H 1991/98

BUS S112/K112 1983/91 ; S113 1993/98 ; L113 1993/98 ; K113 1994/98 ;

DN11/DS11/DSC11 6 CYLINDERS 24 VALVES 11 LITERS UNIFIED (SERIES 2 / 3)

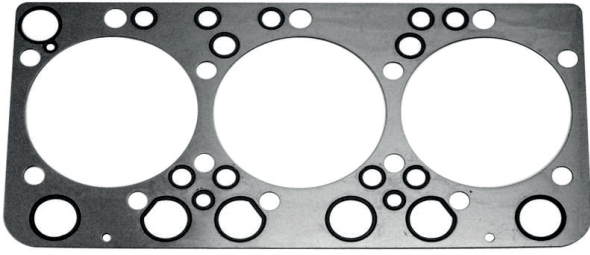

53725105

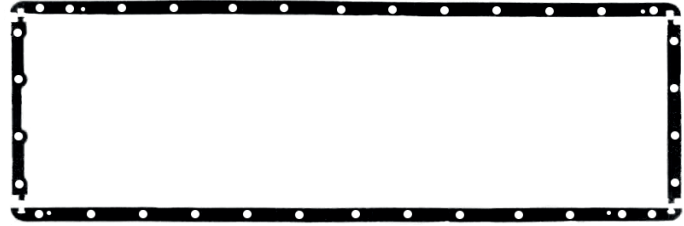

53709490

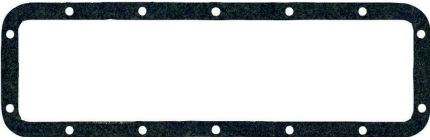

53705167

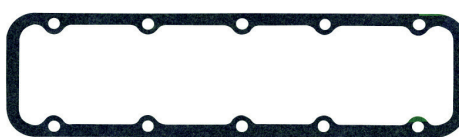

53705790

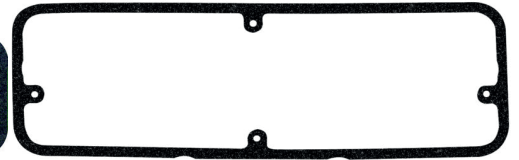

53704850

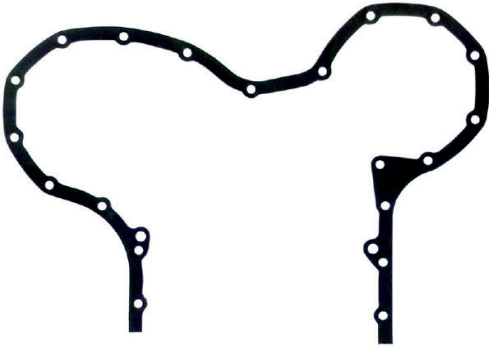

53707085

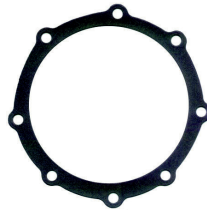

53708667

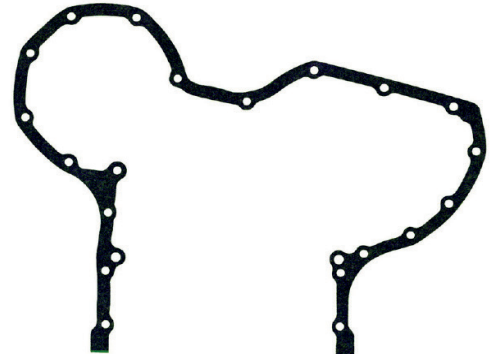

53707567

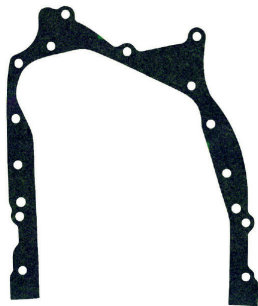

53705267

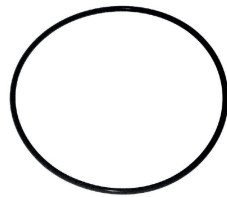

50029243

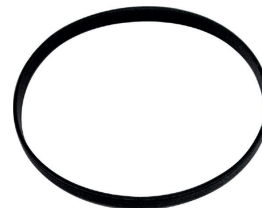

53754440

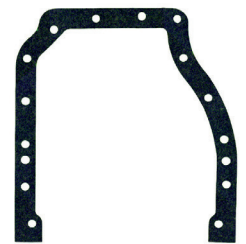

53706567



53704990



53723616



53725890



53725790



53715117



53715217



53725967



53705090

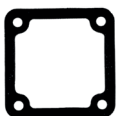

53717667



53726467



53714867



53726267



53715067



53706867



53717467



53726367

DN11/DS11/DSC11 6 CYLINDERS 24 VALVES 11 LITERS UNIFIED (SERIES 2 / 3)

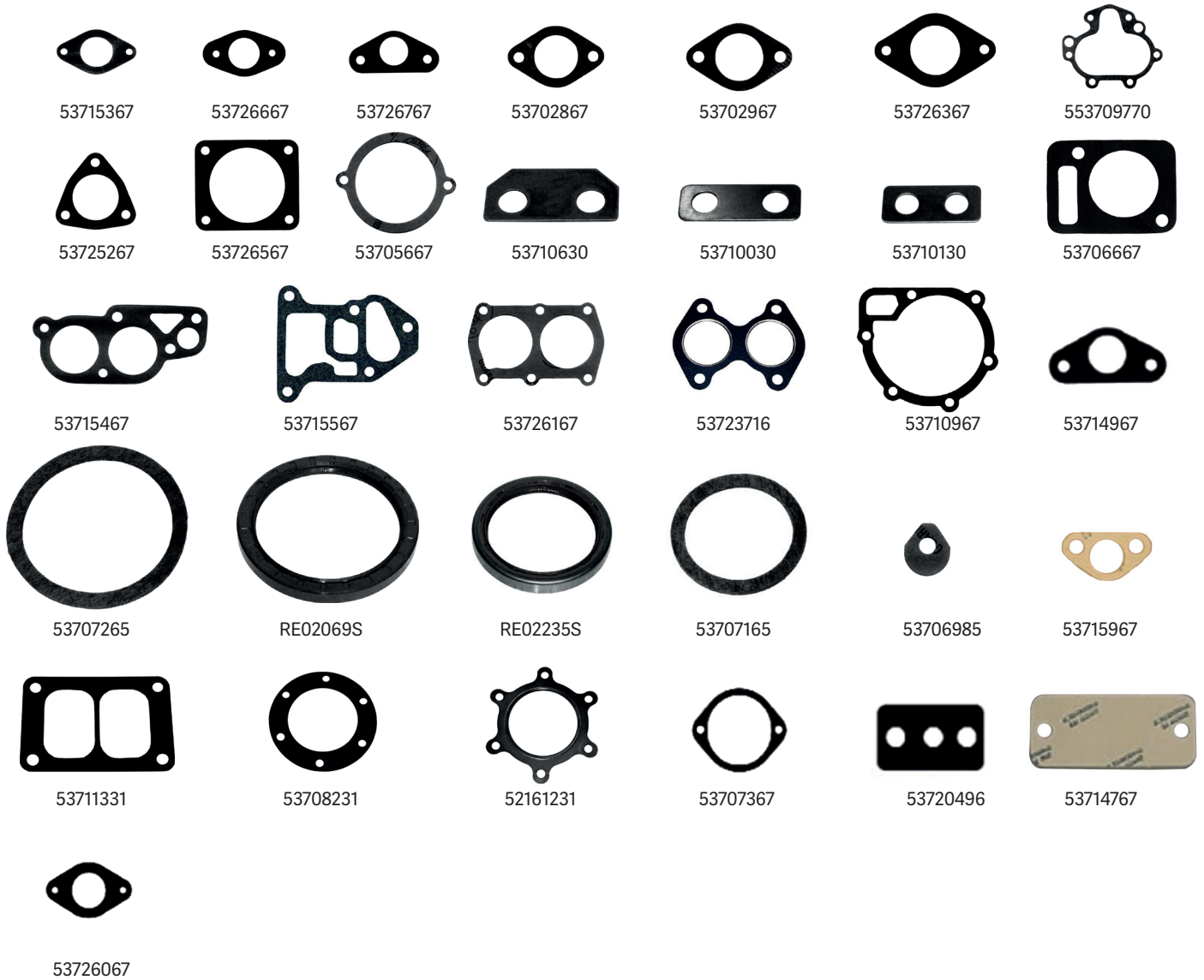

83727741		KIT RUBBERS	
N° ABR	DESCRIPTION	QTD	
50028141	SEAL 106,7 X 3,5 MM	1	
50027941	SEAL 106,5 X 2,1 MM	1	
50005741	SEAL 20,0 X 4,0 MM	3	
50010941	SEAL 26,0 X 3,2 MM	2	
50009141	SEAL 59,0 X 3,4 MM	1	
50028841	SEAL 126,0 X 5,0 MM	1	
50029141	SEAL 135,0 X 2,8 MM	2	
50030741	SEAL 43,5 X 3,4 MM	2	
50031441	SEAL 53,0 X 3,3 MM	2	
50034241	SEAL 10,2 X 3,2 MM	1	
50035841	SEAL 41,5 X 56,3 X 3,5 MM	1	
50036941	SEAL 13,0 X 2,5 MM	2	
50039641	SEAL 16,0 X 2,4 MM	1	
50040541	SEAL 19,0 X 3,2 MM	3	
50054541	SEAL 34,5 X 46,0 X 2,5 MM	1	
50055141	SEAL 18,0 X 29,0 X 4,3 MM	4	
50026841	SEAL 74,2 X 3,5 MM	2	
53702441	THERMATATIC SEAL	1	
53751041	VALVE COVER SEAL	4	

83727629		KIT WASHERS	
N° ABR	DESCRIPTION	QTD	
50011323	COPPER WASHER 8,3 X 13,8 X 1,0 MM	1	
50014120	STEEL WASHER 9,5 X 20,0 X 2,0 MM	6	
50021229	ALUMINUM WASHER 14,0 X 20,0 X 1,5 MM	10	
50018529	ALUMINUM WASHER 12,0 X 16,0 X 1,5 MM	8	
50011223	COPPER WASHER 8,0 X 12,0 X 1,0 MM	14	
50071228	ALUMINUM WASHER 26,4 X 33,7 X 1,0 MM	1	
50025829	ALUMINUM WASHER 18,5 X 23,9 X 1,5 MM	1	
50015528	ALUMINUM WASHER 10,0 X 16,0 X 1,0 MM	12	
	COPPER WASHER 10,2 X 21,3 X 1,8 MM	6	
50015429	ALUMINUM WASHER 10,0 X 14,0 X 1,5 MM	4	
50026728	ALUMINUM WASHER 20,0 X 26,0 X 1,0 MM	2	

83727526		HEAD KIT WASHERS	
N° ABR	DESCRIPTION	QTD	
50014120	COPPER WASHER 9,5 x 20,0 x 2,0 MM	6	
50021229	ALUMINUM WASHER 14,0 x 20,0 x 1,5 MM	4	
50018529	ALUMINUM WASHER 12,0 x 16,0 x 1,5 MM	8	
50012223	COPPER WASHER 8,0 x 12,0 x 1,0 MM	14	

DN11/DS11/DSC11 6 CYLINDERS 24 VALVES 11 LITERS UNIFIED (SERIES 2 /3)

Nº SET		DESCRIPTION		
73710435		FULL GASKET SET DN11/DS11/DSC11 WITH OIL SEAL WITHOUT LINER RINGS	1	
63730435		HEAD GASKET SET DN11/DS11/DSC11 WITHOUT OIL SEAL WITHOUT LINER RINGS	2	
Nº ABR	Nº ORIGINAL	DESCRIPTION		
53725105	373472	CYLINDER HEAD GASKET Ø148MM	2	2
53704850	131103	VALVE COVER GASKET	2	2
53715117	131294	EXHAUST MANIFOLD GASKET	2	2
53715217	131295	EXHAUST MANIFOLD GASKET	2	2
53723616	1109288	EXHAUST MANIFOLD GASKET	2	2
53723716	378264	EXHAUST MANIFOLD GASKET	2	2
53725790	1675584	INTAKE MANIFOLD GASKET	2	2
53725890	1675583	INTAKE MANIFOLD GASKET	2	4
53705785	277632	INTAKE MANIFOLD GASKET	2	2
53709490	2155242	OIL PAN GASKET		1
53707085	139144	FRONT TIMING CASE COVER GASKET		1
53707598	1675602	FRONT TIMING CASE COVER GASKET		1
53706567	287555	FLYWHEEL COVER GASKET		1
53705267	287554	REAR TIMING CASE COVER GASKET	1	1
RE02069S		REAR CRANKSHAFT OIL SEAL 130X160X15MM		1
RE02235S		FRONT CRANKSHAFT OIL SEAL 80X100X12MM		1
52161231		ELBOW TURBOCHARGING GASKET		1
53702867	35161	WATER TUBE GASKET	1	1
53702967	35309	OIL BREATHER GASKET	1	1
53704990	131131	CYLINDER HEAD HOSE GASKET	1	1
53705090	131133	THERMOSTAT GASKET	2	2
53705167	131166	SLIDE COVER GASKET	2	2
53705667	139274	COVER HOUSING GASKET		1
53706667	139044	THERMOSTATIC COVER GASKET	1	1
53706867	277637	OIL FILTER GASKET	1	1
53706985	139123	ROCKER SUPPORT GASKET	6	6
53707165	139146	FRONT CRANKSHAFT GASKET		1
53707265	139149	REAR CRANKSHAFT GASKET		1
53707367	131305	INJECTOR PUMP GASKET	1	1
53708231		ELBOW TURBOCHARGING GASKET		1
53708667	162142	PULLEY BEARING FIXATION GASKET	1	1
53709770	238775	OIL PUMP GASKET		1
53710030	131043	CONNECTING ROD GASKET (SMALL)		3
53710130		CONNECTING ROD GASKET		1
53710630	139493	CONNECTING ROD GASKET (BIG)		1
53710967	131236	WATERPUMP GASKET	1	1
53711331		TURBOCHARGING GASKET		1
53714767		OIL SEAL GASKET	1	1
53714867	170765	OIL FILTER GASKET	1	1
53714967		OIL SEAL GASKET	1	1
53715067	232961	OIL RADIATOR GASKET	1	1
53715367	235610	OIL TUBE GASKET	1	1
53715467	238148	THERMOSTATIC COVER GASKET		1
53715567	283403	OIL FILTER GASKET DE ÓLEO	1	1
53715967		OIL TUBE GASKET		1
53717467	238309	HYDRAULIC PUMP GASKET	1	1
53717667	272793	OIL COVER GASKET	1	1
53720496	142972	WITHPRESSOR GASKET	1	1
53720767		INLET TURBOCHARGING GASKET		1
53725267	292759	INLET WATER TUBE GASKET	1	1
53725967	295050	THERMOSTAT GASKET	1	1
53726067	287559	BREATHER GASKET	2	2
53726167	271238	THERMOSTAT GASKET	1	1
53726267	338332	INTAKE MANIFOLD GASKET	1	1
53726367	277633	SLIDE COVER GASKET	1	1
53726467	287334	THERMOSTAT GASKET	1	1
53726567	287559	EXHAUST MANIFOLD GASKET	1	1
53726667		OIL SEAL GASKET	1	1
53726767		OIL SEAL GASKET	1	1
50029243		LINER RING		
53754440	1302828	LINER SHIM		
83727526		HEAD KIT WASHERS	1	
83727629		KIT WASHERS		1
83727741		KIT RUBBERS		1

• SOLD SEPARATELY

DN11/DS11/DSC11 6 CYLINDERS 24 VALVES 11 LITERS UNIFIED (SERIES 2 / 3)

APPLICATION

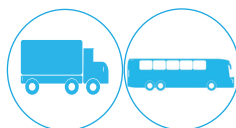

TRUCK 112H 1982/86 ; 112HS 1987/89 ; 112HW 1989/91 ; R113E/R113H 1991/98 ; T113E/T113H 1991/98

BUS S112/K112 1983/91 ; S113 1993/98 ; L113 1993/98 ; K113 1994/98 ;

DN11/DS11/DSC11 6 CYLINDERS 24 VALVES 11 LITERS UNIFIED (SERIES 2 / 3)

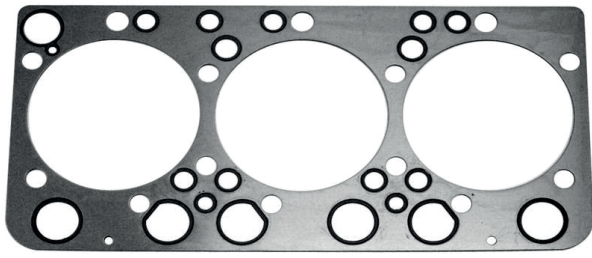

53725105

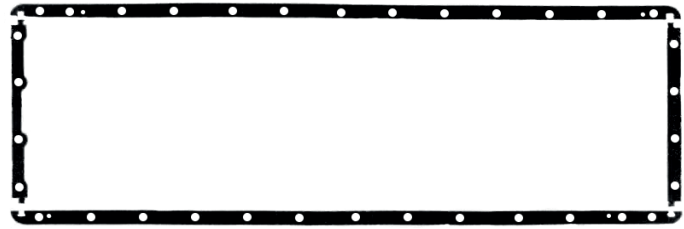

53709490

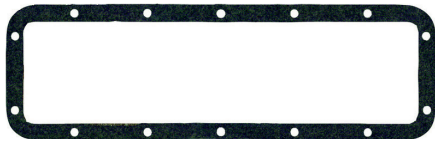

53705167

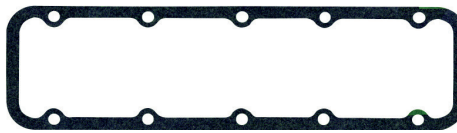

53705790

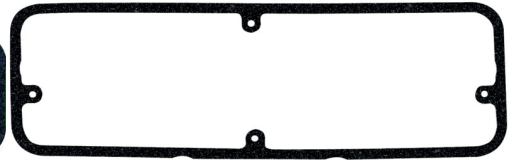

53704850

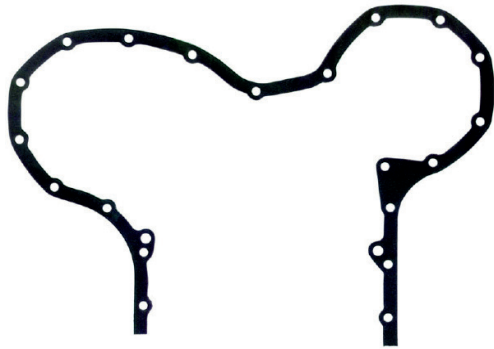

53707085

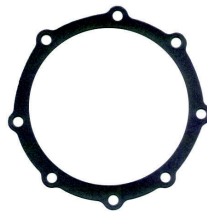

53708667

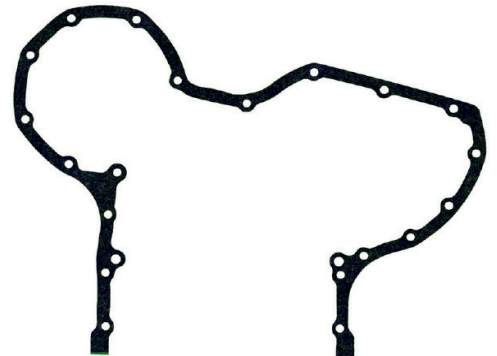

53707567

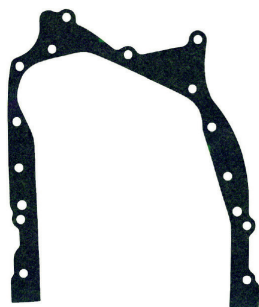

53705267

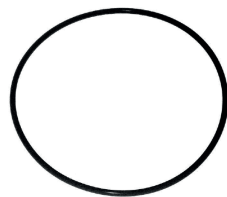

50029243

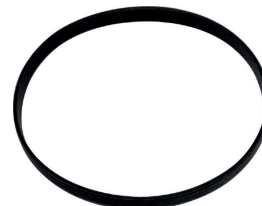

53754440

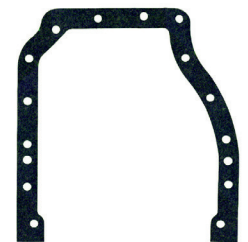

53706567



53704990



53723616



53725890



53725790



53715117



53715217



53725967



53705090

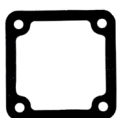

53717667



53726467



53714867



53726267



53715067



53706867



53717467



53726367

DN11/DS11/DSC11 6 CYLINDERS 24 VALVES 11 LITERS UNIFIED (SERIES 2 / 3)

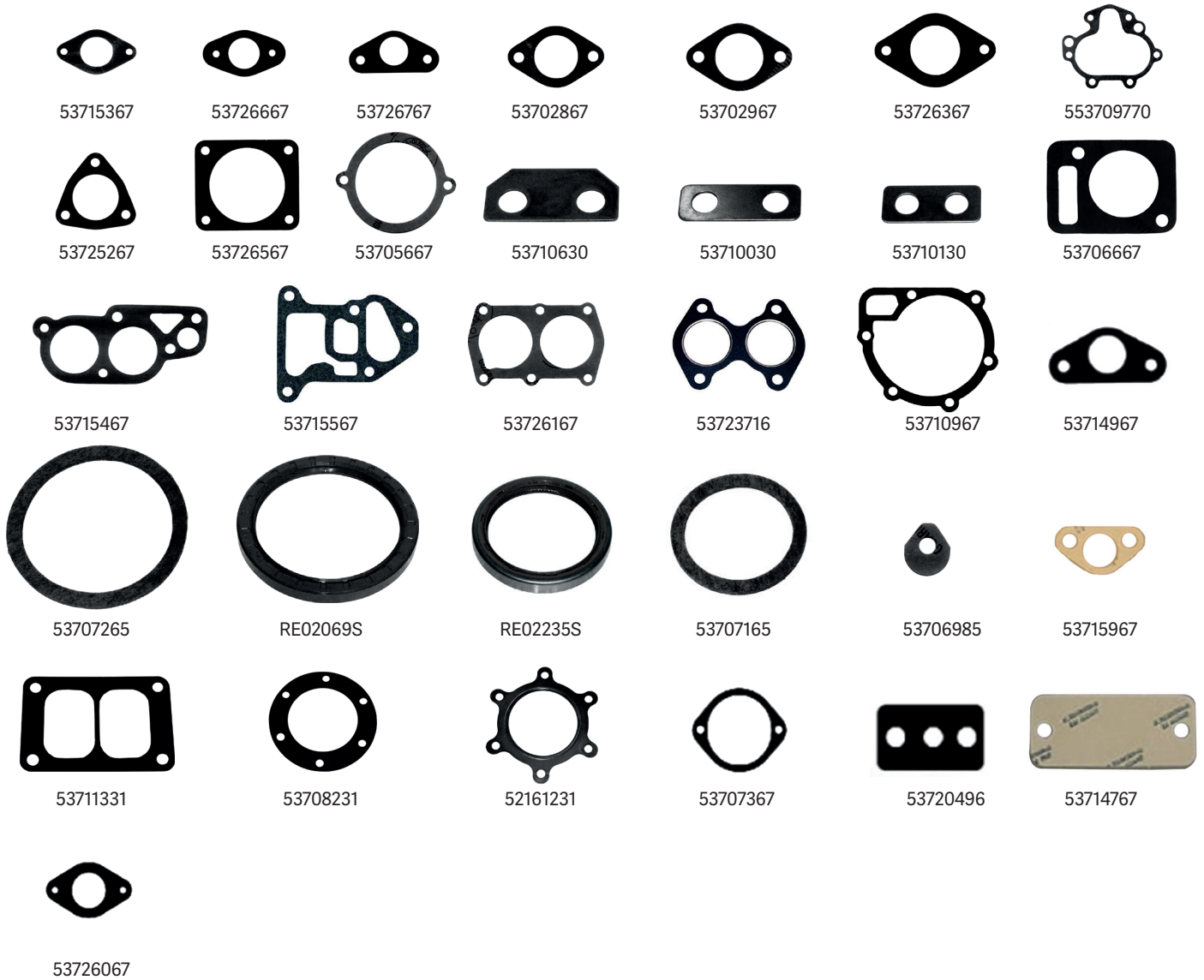

83727741 KIT RUBBERS			
N° ABR	DESCRIPTION		QTD
50028141	SEAL 106,7 X 3,5 MM		1
50027941	SEAL 106,5 X 2,1 MM		1
50005741	SEAL 20,0 X 4,0 MM		3
50010941	SEAL 26,0 X 3,2 MM		2
50009141	SEAL 59,0 X 3,4 MM		1
50028841	SEAL 126,0 X 5,0 MM		1
50029141	SEAL 135,0 X 2,8 MM		2
50030741	SEAL 43,5,0 X 3,4 MM		2
50031441	SEAL 53,0 X 3,3 MM		2
50034241	SEAL 10,2 X 3,2 MM		1
50035841	SEAL 41,5 X 56,3 X 3,5 MM		1
50036941	SEAL 13,0 X 2,5 MM		2
50039641	SEAL 16,0 X 2,4 MM		1
50040541	SEAL 19,0 X 3,2 MM		3
50054541	SEAL 34,5 X 46,0 X 2,5 MM		1
50055141	SEAL 18,0 X 29,0 X 4,3 MM		4
50026841	SEAL 74,2 X 3,5 MM		2
53702441	THERMATATIC SEAL		1
53751041	VALVE COVER SEAL		4

83727629 KIT WASHERS			
N° ABR	DESCRIPTION		QTD
50011323	COPPER WASHER 8,3 X 13,8 X 1,0 MM		1
50014120	STEEL WASHER 9,5 X 20,0 X 2,0 MM		6
50021229	ALUMINUM WASHER 14,0 X 20,0 X 1,5 MM		10
50018529	ALUMINUM WASHER 12,0 X 16,0 X 1,5 MM		8
50011223	COPPER WASHER 8,0 X 12,0 X 1,0 MM		14
50071228	ALUMINUM WASHER 26,4 X 33,7 X 1,0 MM		1
50025829	ALUMINUM WASHER 18,5 X 23,9 X 1,5 MM		1
50015528	ALUMINUM WASHER 10,0 X 16,0 X 1,0 MM		12
	COPPER WASHER 10,2 X 21,3 X 1,8 MM		6
50015429	ALUMINUM WASHER 10,0 X 14,0 X 1,5 MM		4
50026728	ALUMINUM WASHER 20,0 X 26,0 X 1,0 MM		2

83727526 HEAD KIT DE WASHERS			
N° ABR	DESCRIPTION		QTD
50014120	COPPER WASHER 9,5 x 20,0 x 2,0 MM		6
50021229	ALUMINUM WASHER 14,0 x 20,0 x 1,5 MM		4
50018529	ALUMINUM WASHER 12,0 x 16,0 x 1,5 MM		8
50012223	COPPER WASHER 8,0 x 12,0 x 1,0 MM		14

DC11/DSC12 6 CYLINDERS 24 VALVES 11,7 LITERS (SERIE 4)

N° SET		DESCRIPTION						
63710129		FULL GASKET SET DC11 WITHOUT OIL SEAL WITH LINER RINGS	1					
73710129		FULL GASKET SET DC11 WITH OIL SEAL WITH LINER RINGS	2					
63710429		FULL GASKET SET DSC12 WITHOUT OIL SEAL WITH LINER RINGS	3					
73710429		FULL GASKET SET DSC12 WITH OIL SEAL WITH LINER RINGS	4					
63710109		FULL GASKET SET DSC12 WITHOUT OIL SEAL WITH LINER RINGS	5					
73710109		FULL GASKET SET DSC12 WITH OIL SEAL WITH LINER RINGS	6					
N° ABR	N° ORIGINAL	DESCRIPTION						
50014049		FRONT CRANKSHAFT GASKET	1	1	1			
50014149		REAR CRANKSHAFT GASKET	1	1	1			
RE09282F		RETENTOR DA HASTE VÁLVUVAS	1	1	1			
53726805	1468555	CYLINDER HEAD GASKET	6	6				
53751167	1374342	INTAKE MANIFOLD GASKET	1	1	1	1	1	1
53751267	1374346	HYDRAULIC PUMP GASKET	1	1	1	1	1	1
53751367	1374334	TIMING COVER GASKET			1	1	1	1
53751467	1374344	WATER PUMP GASKET	1	1	1	1	1	1
53751567	1374336	TUBE GASKET	1	1	1	1	1	1
53751667	1375992	PIPE OIL GASKET	1	1	1	1	1	1
53751867	1374517	OIL FILTER GASKET DE ÁGUA	1	1	1	1	1	1
53753331	1374340	INTAKE MANIFOLD GASKET			6	6	6	6
53752147	1309051	EXHAUST MANIFOLD GASKET	6	6	6	6	6	6
53752267	1375387	BETWEEN MANIFOLD GASKET	1	1	1	1	1	1
53752367	1374346	HYDRAULIC PUMP GASKET	1	1	1	1	1	1
53752467	1375383	SLIDE COVER GASKET	3	3	3	3	3	3
53752667	1374327	BETWEEN MANIFOLD GASKET	1	1	1	1	1	1
53752767	1374330	OIL DIPSTICK GASKET	1	1	1	1	1	1
53752867	1391726	OIL COOLER GASKET	1	1	1	1	1	1
53752967	1374326	SLIDE COVER GASKET	3	3	3	3	3	3
53753067	1460359	OIL PAN GASKET	1	1	1	1	1	1
53753167	1374333	THERMOSTATIC GASKET	1	1	1	1	1	1
53754540	1445514	SLIDE COVER GASKET	1	1				
53754640	1433886	OIL RADIATOR GASKET	1	1				
53754705	1377039	CYLINDER HEAD GASKET			6	6	6	6
53754867	1403129	TIMING COVER GASKET	1	1				
82160177		KIT TURBOCHARGING	1	1	1	1	1	1
83728640		KIT VALVE COVER					1	1
83728740		KIT VALVE COVER	1	1	1	1		
83728940		KIT RUBBERS	1	1	1	1	1	1
83729029		KIT WASHERS	1	1	1	1	1	1
83728840		KIT RUBBERS			1	1	1	1
83729340		KIT RUBBERS	1	1				

● SOLD SEPARATELY

DC11/DSC12 6 CYLINDERS 24 VALVES 11,7 LITERS (SERIE 4)

APPLICATION

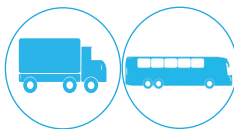

SCANIA DC11 6 CYL 24V 10.60L SERIES 4 MECANICO(EURO 3)

SCANIA TRUCK P114 1998/02 ; P124 1998/00 ; T124 1998/01 ; R114 1998/01 ; T114 1998/01

SCANIA DSC12 6 CYL 24V 11.70L SERIES 4 MECANICO(EURO 3)

SCANIA TRUCK R114 1999/99 ; R124 1998/01 ; T124 1998/01

SCANIA BUS K124 1999/01

SCANIA DSC12 6 CYL 24V 11.70L SERIES 4 ELETTRONICO(EURO 3)

SCANIA TRUCK P114/R114/T114 2002/07 ; P124/R124/T124 2002/07

SCANIA BUS K124 2002/07

DC11/DSC12 6 CYLINDERS 24 VALVES 11,7 LITERS (SERIE 4)



53754705

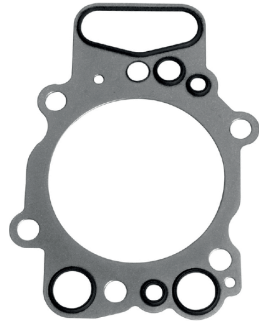

53726805

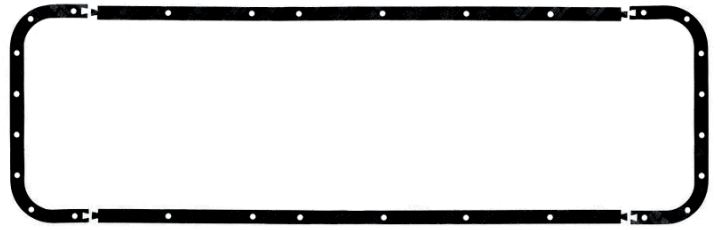

53753067

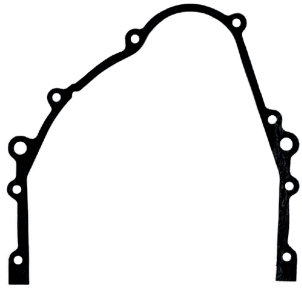

53751367

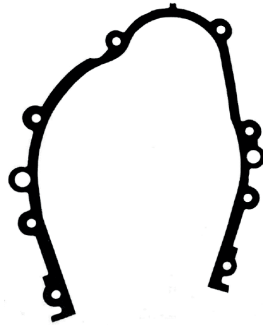

53754867



53752367

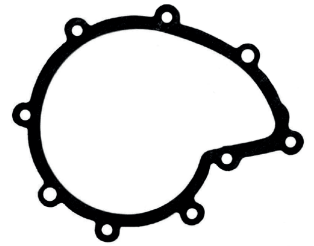

53751467

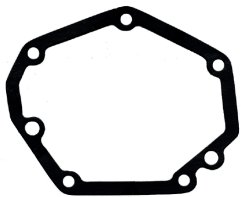

53752367

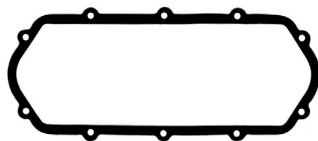

53752467

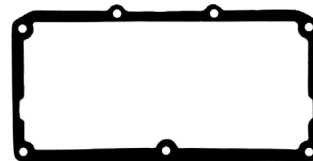

53752967

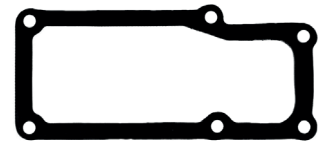

53753167



53751867



53752867

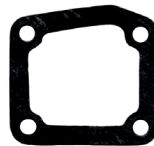

53752767



53752267



53752147



53751667



53751167

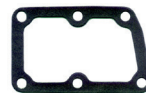

53751267



53753331



53753230

83728640

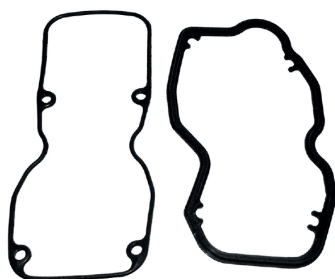

83728740

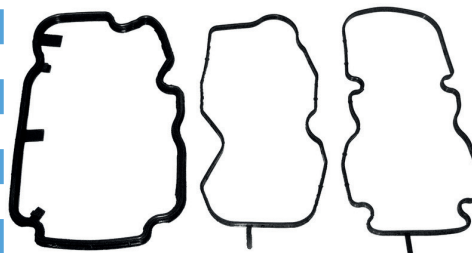

82160177



DC11/DSC12 6 CYLINDERS 24 VALVES 11,7 LITERS (SERIES 4)

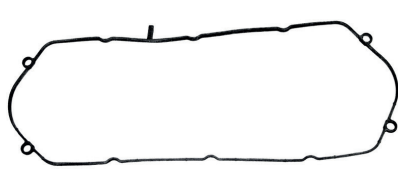
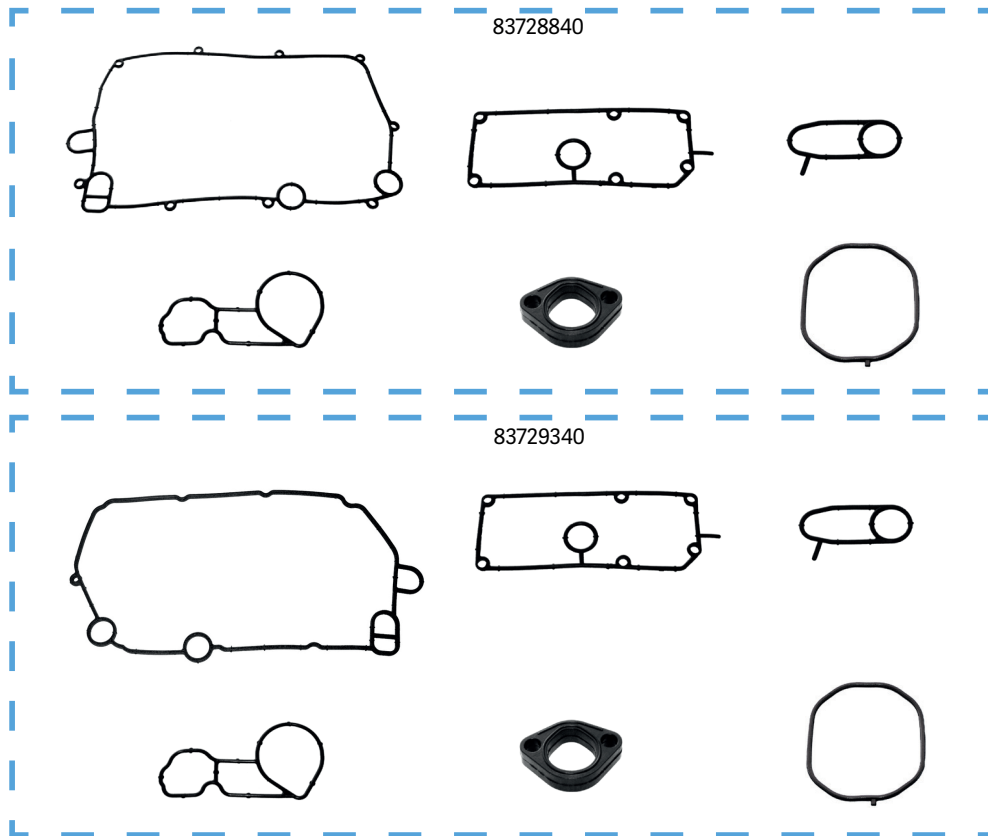

53754540

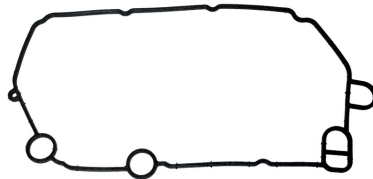

53754640



50014149



50014049



53751567



RE09282F

83728940		KIT RUBBERS	
N° ABR	DESCRIPTION		QTD
50028141	SEAL 106,7 X 3,5 MM		1
50027941	SEAL 106,5 X 2,1 MM		1
50005741	SEAL 20,0 X 4,0 MM		3
50010941	SEAL 26,0 X 3,2 MM		2
50009141	SEAL 59,0 X 3,4 MM		1
50028841	SEAL 126,0 X 5,0 MM		1
50029141	SEAL 135,0 X 2,8 MM		2
50030741	SEAL 43,5,0 X 3,4 MM		2
50031441	SEAL 53,0 X 3,3 MM		2
50034241	SEAL 10,2 X 3,2 MM		1
50035841	SEAL 41,5 X 56,3 X 3,5 MM		1
50036941	SEAL 13,0 X 2,5 MM		2
50039641	SEAL 16,0 X 2,4 MM		1
50040541	SEAL 19,0 X 3,2 MM		3
50054541	SEAL 34,5 X 46,0 X 2,5 MM		1
50055141	SEAL 18,0 X 29,0 X 4,3 MM		4
50026841	SEAL 74,2 X 3,5 MM		2
53702441	THERMATATIC SEAL		1
53751041	VALVE COVER SEAL		4

83729029		KIT WASHERS	
N° ABR	DESCRIPTION		QTD
56114120	COPPER WASHER 9,5 x 20,0 x 2,0 MM		6
50021228	ALUMINIUM WASHER 14,0 x 20,0 x 1,0 MM		20
50018529	ALUMINIUM WASHER 12,0 x 16,0 x 1,5 MM		8
50011228	ALUMINIUM WASHER 8,0 x 12,0 x 1,0 MM		18
50029827	ALUMINIUM WASHER 24,0 x 38,0 x 1,0 MM		1
50072429	ALUMINIUM WASHER 22,5 x 26,7 x 1,5 MM		2
50023329	ALUMINIUM WASHER 16,0 x 22,0 x 1,5 MM		6
50023629	ALUMINIUM WASHER 16,3 x 19,8 x 1,5 MM		8
50015428	ALUMINIUM WASHER 10,0 x 14,0 x 1,0 MM		4

DC11/DSC12 8 CYLINDERS 24 VALVES 11,7 LITERS (EURO 3)

N° SET		DESCRIPTION					
63730121	MONOCYLINDER GASKET SET DC11 WITHOUT OIL SEAL WITHOUT LINER RINGS						1
73730121	MONOCYLINDER GASKET SET DC11 WITH OIL SEAL WITHOUT LINER RINGS						2
63730421	MONOCYLINDER GASKET SET DSC12 WITHOUT OIL SEAL WITHOUT LINER RINGS						3
73730421	MONOCYLINDER GASKET SET DSC12 WITH OIL SEAL WITHOUT LINER RINGS						4
63730101	MONOCYLINDER GASKET SET DSC12 WITHOUT OIL SEAL WITHOUT LINER RINGS						5
73730101	MONOCYLINDER GASKET SET DSC12 WITH OIL SEAL WITHOUT LINER RINGS						6
N° ABR	N° ORIGINAL	DESCRIPTION					
53726805	1468555	CYLINDER HEAD GASKET				1	1
53754705	1377039	CYLINDER HEAD GASKET					1 1 1 1
53753331	1374340	INTAKE MANIFOLD GASKET					1 1 1 1
53753331	1309051	EXHAUST MANIFOLD GASKET				1	1 1 1 1
RE09282F		VALVE STEM SEAL				4	4 4
53753230	1374842	WASHER 9,3X13X1X1,00 MM				6	6 6 6 6
53755340	1340615	INJECTOR TUBE SEAL				4	4 4 4 4
53755340	1368061	FUEL PUMP SEAL				1	1 1 1 1
50014120		INJECTION WASHER NOZZLE				1	1 1 1 1
83728640		VALVE COVER GASKET SET					1 1
83728740		VALVE COVER GASKET SET				1	1 1

● SOLD SEPARATELY

DC11/DSC12 8 CYLINDERS 24 VALVES 11,7 LITERS (EURO 3)

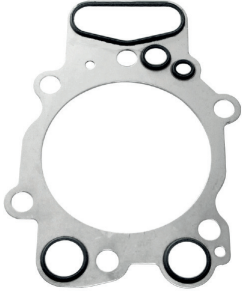

53754705

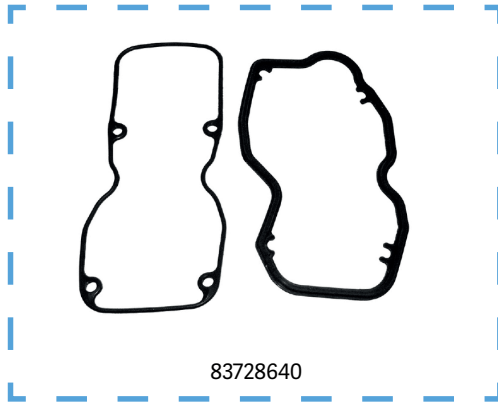

83728640

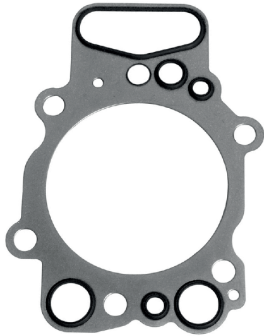

53726805

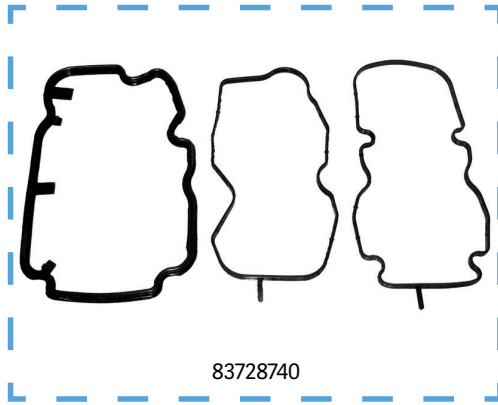

83728740



53752147



53753331



53753230



53755240



53755340



50014120



RE09282F

DS14 - LK140 / LK141 8 CYLINDERS 1974

Nº SET

73712535 FULL GASKET SET DS14/LK141 WITH OIL SEAL WITHOUT LINER RINGS

1

63732535 MONOCYLINDER GASKET SET DS14/LK140/LK141 WITHOUT OIL SEAL WITHOUT LINER RINGS

2

Nº ABR Nº ORIGINAL DESCRIPTION

53711405	170274	CYLINDER HEAD GASKET	1	8
53718898	170702	SLIDE COVER GASKET DAS VALVES		1
53718416	170907	EXHAUST MANIFOLD GASKET		1
53713616	170363	EXHAUST MANIFOLD GASKET	1	8
53718996	170700	OIL PAN GASKET (SECTIONED)		1
RE02069S	2069	REAR CRANKSHAFT OIL SEAL 130,0 X 160,0 X 15,0 MM		1
RE02235S	2235	FRONT CRANKSHAFT OIL SEAL 80,0 X 100,0 X 12,0 MM		1
RE00266N	266	INJECTOR PUMP SEAL		1
53707165	139146	FRONT CRANKSHAFT GASKET		1
53707265	139149	REAR CRANKSHAFT GASKET		1
53710030	131043	CONNECTING ROD GASKET - SMALL		3
53710341	170610	VALVE STEM SEAL	1	8
53710530	131438	DISTRIBUTION GEAR LOCK		2
53710630	139493	CONNECTING ROD GASKET - BIG		1
53713767	170372	REAR TIMING CASE COVER GASKET		1
53716285	170696	FRONT SUPPORT BLOCK GASKET		4
53716385	170686	WATER PUMP SUPPORT GASKET		1
53716467	170966	VENTILATION TUBE GASKET		1
53716590	170368	WATER PUMP GASKET	1	8
53716680	277607	INTAKE MANIFOLD GASKET	1	8
53716780	170675	ROCKER SUPPORT GASKET	2	16
53716867	170916	COVER HOUSING GASKET		1
53716990		GASKET		1
53717067	170937	INLET OIL TUBE GASKET		1
53717190	170804	LUBRIFICANT TUBE GASKET		1
53717290	170366	INTAKE MANIFOLD GASKET LEFT		1
53717390	170687	WATER PUMP HOUSING GASKET - SMALL	1	1
53717467	332598	HYDRAULIC PUMP GASKET		1
53717567	252804	THERMOSTATIC VALVE GASKET		3
53717667	272793	OIL LEVEL GASKET		1
53717767	170765	CHAMBER FILTER GASKET		1
53717867	247990	OIL FILTER GASKET DO ÓLEO		1
53717990	170706	COVER HOUSING GASKET		1
53718090	170627	SLIDE CYLINDER COVER GASKET	1	8
53718190	287559	INTAKE MANIFOLD GASKET		1
53718316	170932	EXHAUST PIPE GASKET - 3 HOLES		2
53718590	170694	SLIDE COVER GASKET		2
53718667	170738	WATER PUMP COVER GASKET		1
53718767	170705	FLYWHEEL COVER GASKET		1
83727829		KIT WASHERS	1	1
83727941		KIT RUBBERS		1

•SOLD SEPARATELY

APPLICATION



SCANIA TRUCK LK140 1975/80 ; LK141 1981/89 ; R142M/R142H/T142M/T142H 1982/86 ; R142HS/R142HW 1987/91 ; T142HS/142HW 1987/91

DS14 - LK140 / LK141 8 CYLINDERS 1974

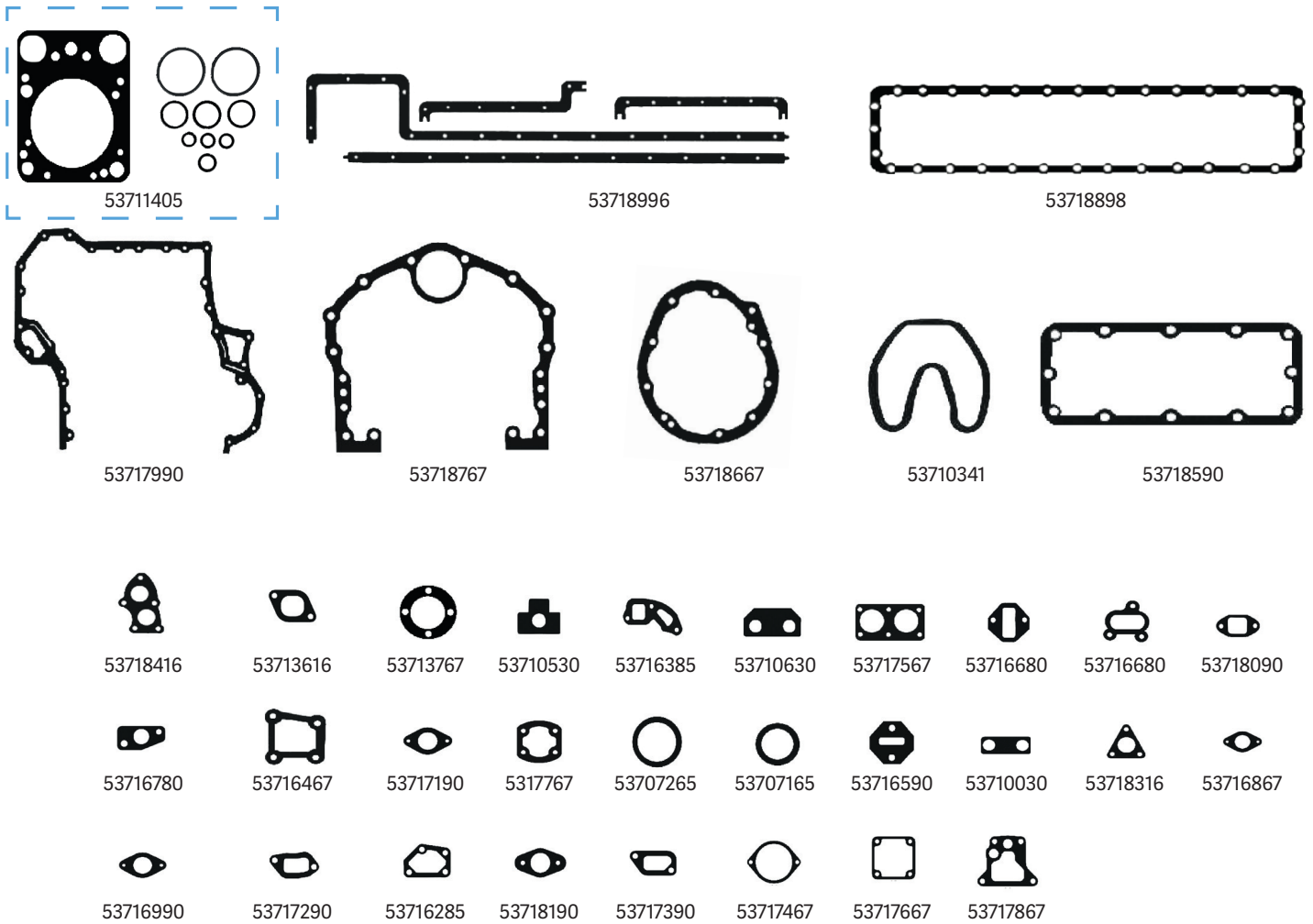

83727941 KIT RUBBERS		
N° ABR	DESCRIPTION	QTD
50000741	SEAL 44,8 X 2,0 MM	1
50005741	SEAL 20,0 X 4,0 MM	8
50006841	SEAL 150,5 X 4,0 MM	1
50010341	SEAL 23,0 X 3,5 MM	1
50010641	SEAL 24,0 X 3,8 MM	2
50010941	SEAL 26,0 X 3,2MM	2
50026241	SEAL 88,8 X 3,0 MM	1
50026841	SEAL 74,2 X 3,5 MM	1
50028141	SEAL 106,7 X 3,5 MM	1
50028841	SEAL 126,0 X 5,0 MM	1
50029141	SEAL 135,0 X 2,8 MM	1
50034241	SEAL 10,2 X 3,2 MM	1
50035141	SEAL 62,3 X 3,1 MM	1
50035841	WASHER RUBBER 41,5 X 56,3 X 3,5 MM	1
50036941	SEAL 13,0 X 2,5 MM	1
50037141	SEAL 14,0 X 3,4 MM	1
50040841	SEAL 20,3 X 3,2 MM	8

KIT WASHERS			
DESCRIPTION	83727829		83728329
	QTD	QTD	
COPPER WASHER 10,3 X 13,8 X 1,0 MM	1		
WASHER DE COBRE 14,1 X 17,8 X 1,0 MM	6		
COPPER WASHER 16,1 X 21,9 X 1,0 MM	2		
COPPER WASHER 21,1 X 27,0 X 1,0 MM	6		
COPPER WASHER 9,6 X 19,9 X 1,5 MM	8		
COPPER WASHER 9,4 X 24,9 X 1,5 MM	8	1	
COPPER WASHER 8,2 X 12,2 X 1,0 MM	25	2	
ALUMINIUM WASHER 15,2 X 19,9 X 2,0 MM	1	5	
ALUMINIUM WASHER 18,2 X 21,9 X 1,0 MM	1		
ALUMINIUM WASHER 16,2 X 21,9 X 1,0 MM	2		
ALUMINIUM WASHER 20,2 X 25,6 X 1,0 MM	2		
ALUMINIUM WASHER 22,0 X 27,0 X 1,5 MM	2		
ALUMINIUM WASHER 10,2 X 14,0 X 1,0 MM	1		
ALUMINIUM WASHER 12,4 X 15,9 X 1,5 MM	4		
ALUMINIUM WASHER 10,0 X 15,9 X 1,0 MM	12		
ALUMINIUM WASHER 6,2 X 9,9 X 1,0 MM	21		
ALUMINIUM WASHER 14,1 X 17,9 X 1,5 MM	31		

//JOHN DEERE

JOHN DEERE

N° ABR	ENGINE	DESCRIPTION	PAGE
60210401	3029D	FULL GASKET SET WITHOUT OIL SEAL	230
70210401	3029D	FULL GASKET SET WITH OIL SEAL	230
60230401	3029D	HEAD GASKET SET WITHOUT OIL SEAL	230
60210301	4045T	FULL GASKET SET WITHOUT OIL SEAL	232
70210301	4045T	FULL GASKET SET WITH OIL SEAL	232
60230301	4045T	HEAD GASKET SET WITHOUT OIL SEAL	232
60210201	6068D	FULL GASKET SET WITHOUT OIL SEAL	234
70210201	6068D	FULL GASKET SET WITH OIL SEAL	234
60230201	6068D	HEAD GASKET SET WITHOUT OIL SEAL	234
60210501	6090T	FULL GASKET SET WITHOUT OIL SEAL	236
60230501	6090T	HEAD GASKET SET WITHOUT OIL SEAL	236

JOHN DEERE 3029D

N° SET		DESCRIPTION			
60210401		FULL GASKET SET JOHN DEERE 3029D WITHOUT OIL SEAL	1		
70210401		FULL GASKET SET JOHN DEERE 3029D WITH OIL SEAL	2		
60230401		HEAD GASKET SET JOHN DEERE 3029D WITHOUT OIL SEAL	3		
N° ABR	N° ORIGINAL	DESCRIPTION			
50203801	R515273	CYLINDER HEAD GASKET	1	1	1
50202950	R75729	VALVE COVER GASKET	1	1	1
RE09138T		REAR CRANKSHAFT OIL SEAL		1	
RE09140T		FRONT CRANKSHAFT OIL SEAL		1	
RE09006S		VALVE STEM SEAL		6	
50203067	R97341	OIL PAN GASKET		1	1
50201647	R521439	EXHAUST MANIFOLD GASKET	3	3	3
50200667	R81275	INTAKE MANIFOLD GASKET	2	2	2
50204032	R90737	TURBOCHANGING GASKET	1	1	1
50203367	R97352	INLET FILTER OIL GASKET		1	1
50201867	R123570	OUTLET OIL FILTER GASKET	1	1	1
50201567	R135896	THERMOSTAT GASKET		1	1
50202567	T20219	THERMOSTAT BLOCK GASKET	1	1	1
50202667	T20243	WATER PUMP GASKET		1	1
50202767	T20273	TIMING CASE COVER GASKET		1	1
50202867	R27285	FUEL PUMP GASKET		1	1
50203167	R97350	FUEL PUMP GASKET		1	1
50203267	R97351	GEARBOX GASKET		1	1
50203467	R97354	INJECTOR FUEL PUMP GASKET		1	1
50203567	R97454	TIMING CASE COVER GASKET		1	1
50203667	R97455	WATER PUMP GASKET		1	1
50203967	R90648	FRONT COVER GASKET		1	1
50204167	T20328	OIL FILTER GASKET		1	1
80002446		KIT RUBBERS		1	1

• SOLD SEPARATELY

APPLICATION



JOHN DEERE 3029D/T 3 CYLINDERS 2.9 LITER ASPIRADO E TURBO

JOHN DEERE TRACTOR 5055E 2011/...5065E/5075E 2010/...5075EF 2012/...5303 2002/11 5403 2002/12

JOHN DEERE 3029D

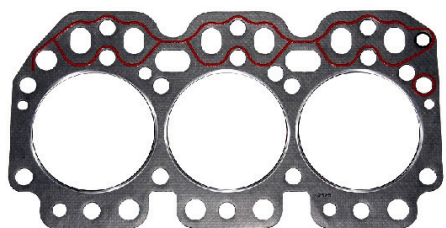

50203801

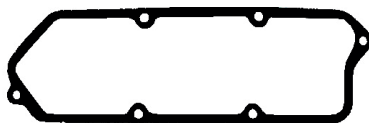

50202950

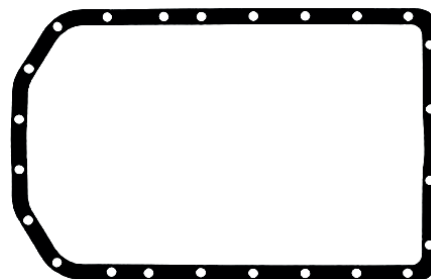

50203067



50203267

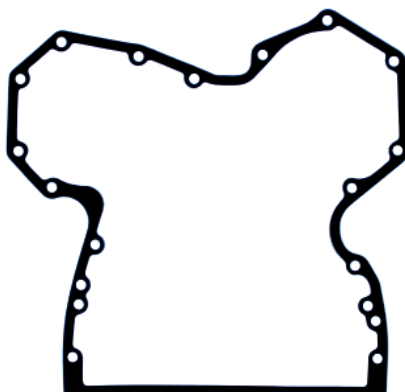

50203567



50203967



50201567



50202567



50201647



50200667



50202867



50203167



50202667

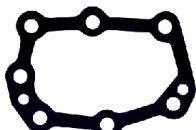

50202767



50204032



50203367



54355544



50203467



50204150



50203667



RE09138T



RE09140T



RE09006S

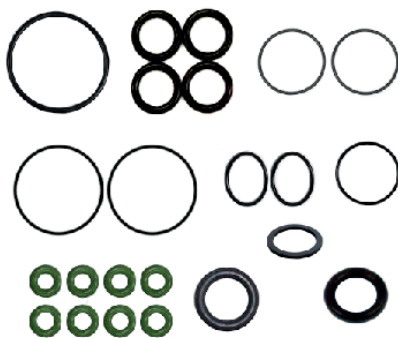

80002446

JOHN DEERE 4045T

N° SET		DESCRIPTION			
60210301		FULL GASKET SET JOHN DEERE 4045T WITHOUT OIL SEAL			1
70210301		FULL GASKET SET JOHN DEERE 4045T WITH OIL SEAL			2
60230301		HEAD GASKET SET JOHN DEERE 4045T WITHOUT OIL SEAL			3
N° ABR	N° ORIGINAL	DESCRIPTION			
50202401	R116515	CYLINDER HEAD GASKET	1	1	1
50200467	R136515	FRONT COVER GASKET		1	1
50200567	R136516	FRONT COVER GASKET		1	1
50200667	R81275	INTAKE MANIFOLD GASKET	1	1	1
50200767	R524480	VALVE COVER GASKET	1	1	1
50200867	R521439	EXHAUST MANIFOLD GASKET	4	4	4
RE09138T		REAR CRANKSHAFT OIL SEAL		1	
RE09140T		FRONT CRANKSHAFT OIL SEAL		1	
RE09006S		VALVE STEM SEAL		8	
50202267	R123353	OIL PAN GASKET		1	1
50200867	R123501	OIL COOLER GASKET		1	1
50201367	R501428	OIL COOLER GASKET		1	1
50200967	R123417	WATER PUMP GASKET		1	1
50201867	R123570	OUTLET TURCHARGING GASKET	1	1	1
50201767	R53108	START ENGINE GASKET		1	1
50201647	R92097	EXHAUST MANIFOLD GASKET	1	1	1
50200767	R501373	THERMOSTAT GASKET		1	1
50201467	R123345	THERMOSTAT GASKET	1	1	1
50201567	R135896	THERMOSTAT GASKET	1	1	1
50201967	R133893	THERMOSTAT GASKET		1	1
50201067	R502864	OIL FILTER GASKET		1	1
50201167	R123525	OIL FILTER GASKET		1	1
50201267	R501484	OIL FILTER GASKET		1	1
50202067	R136495	OIL FILTER GASKET		1	1
80200346		KIT RUBBERS		1	1

● SOLD SEPARATELY

APPLICATION



JOHN DEERE 4045D/T 4 CYLINDERS 4.5 LITER ASPIRADO E TURBO

JOHN DEERE TRACTOR 5078E 2010/...5425N 2006/15 5600 1998/05 5603 2001/12 5605 2002/12 6125J 2009/...5085E/5090E 2010/...

5700 1996/04 5705 2001/11 6110D/6110J/6125D 2009/...6110E/6125E 2010/...6300 1998/04 6405 2002/11 6415 1998/11

JOHN DEERE 4045T

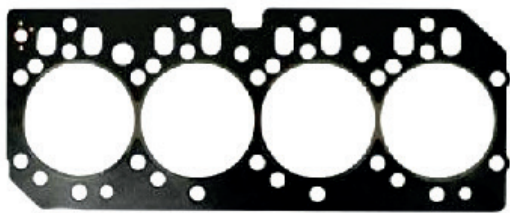

50202401

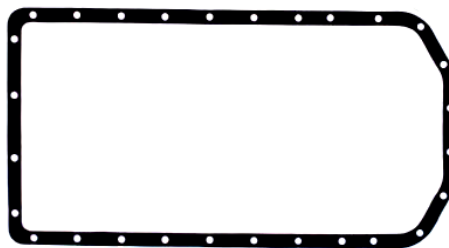

50202340

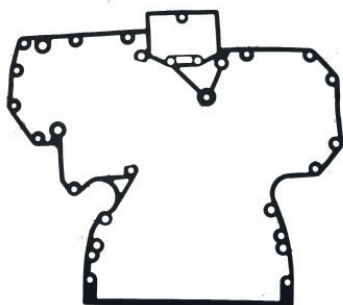

50200667

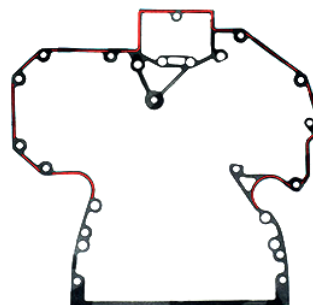

50200567



50202340



50200967

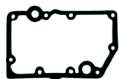

50200867



50201167



50201067



50201367



50201647



50201867



50200667



50201767



50201567



50201467



50201267



50202130



50202067



50201967



50200767



RE09138T



RE09140T



RE09006S

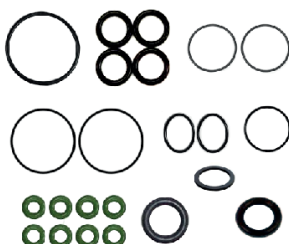

80200346

JOHN DEERE 6068D

N° SET		DESCRIPTION			
60210201	FULL GASKET SET JOHN DEERE 6068D WITHOUT OIL SEAL		1		
70210201	FULL GASKET SET JOHN DEERE 6068D WITH OIL SEAL		2		
60230201	HEAD GASKET SET JOHN DEERE 6068D WITHOUT OIL SEAL		3		
N° ABR	N° ORIGINAL	DESCRIPTION			
50200101	R116516	CYLINDER HEAD GASKET	1	1	1
50200340	R123543	VALVE COVER GASKET	1	1	1
50200267	R123354	OIL PAN GASKET		1	1
RE09139T		REAR CRANKSHAFT OIL SEAL		1	
RE09140T		FRONT CRANKSHAFT OIL SEAL		1	
RE09006S		VALVE STEM SEAL		12	
50201647	R521439	EXHAUST MANIFOLD GASKET	6	6	6
50200667	R81275	INTAKE MANIFOLD GASKET	1	1	1
52161031	R123572	TURBOCHARGING GASKET	1	1	1
50201867	R123570	OUTLET TURBOCHARGING GASKET	1	1	1
50200467	R136515	FRONT COVER GASKET		1	1
50200567	R136516	FRONT COVER GASKET		1	1
50200767	R501373	THERMOSTAT GASKET	1	1	1
50200867	R123501	OIL COOLER GASKET		1	1
50200967	R123417	WATER PUMP GASKET		1	1
50201067	R502864	OIL FILTER GASKET		1	1
50201167	R123525	OIL FILTER GASKET		1	1
50201267	R501484	OIL FILTER GASKET		1	1
50201367	R501428	OIL COOLER GASKET		1	1
50201467	R123345	THERMOSTAT GASKET	1	1	1
50201767	R53108	START ENGINE GASKET		1	1
50201967	R133893	THERMOSTAT GASKET		1	1
50201567	R135896	THERMOSTAT GASKET	1	1	1
50202067	R136495	OIL FILTER GASKET		1	1
50030724		WASHER		1	1
80200246		KIT RUBBERS		1	1

● SOLD SEPARATELY

APPLICATION



JOHN DEERE 6068D/T 6 CYLINDERS 6.8 LITER TURBO

JOHNDEERE TRACTOR 6130J/6145J 2010/...6135J 2009/...7715 2006/11 7810 1998/07 7815 2004/11 6165J 2010/17 6600 1995/04

6180J/6205J 2010/...6605 2002/06 6615 2006/11 7185J 2010/12 7195J/7205J 2009/17 7210J 2009/...7225J 2010/17 7500 1999/03 7505 2001/06 7515 2007/11

COMBINE S430/S440 2017/...S540/S550 2015/...1165 1998/04 1175 1999/17 1185 1999/09 1250/1450 1998/14 1470 2010/17 9470/9570 2010/15

JOHN DEERE 6068D

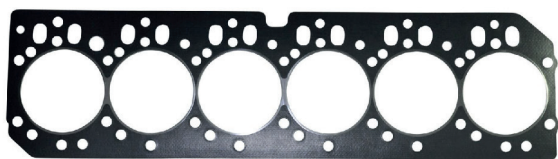

50200101



50200267

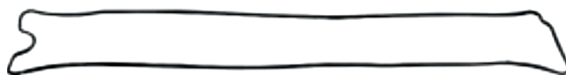

50200340

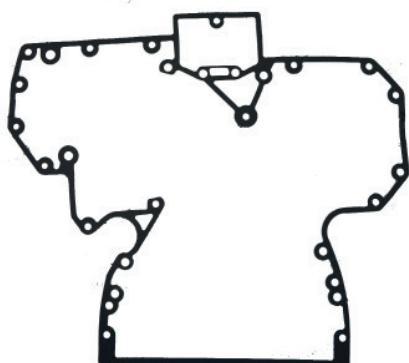

50200467

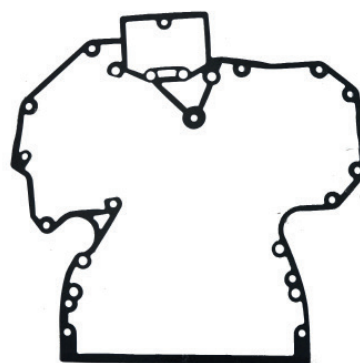

50200567



50201647



50200667



52161031



50201867



50200767



50200867



50200967



50201067



50201167



50201267



50201467



50201767



50201967



50201567



50202067



50201367



50030724



RE09139T



RE09140T



RE09006S

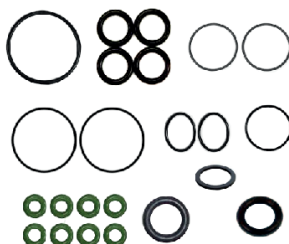

80200246

JOHN DEERE 6090T

N° SET		DESCRIPTION		
60210501		FULL GASKET SET JOHN DEERE 6090T WITHOUT OIL SEAL	1	
60230501		HEAD GASKET SET JOHN DEERE 6090T WITHOUT OIL SEAL	2	
N° ABR	N° ORIGINAL	DESCRIPTION		
50204301	R525541	CYLINDER HEAD GASKET	1	1
50204540	R526607	VALVE COVER GASKET	1	1
50204447	R527884	ROCKER COVER GASKET	1	1
50204867	R100569	OIL PAN BREATHER GASKET	1	1
50204867	RE520777	OIL PAN GASKET		1
50204867	R520844	OIL PAN GASKET		1
50204947	R5208260	INTAKE MANIFOLD GASKET	1	1
50205067	R519414	INTAKE MANIFOLD GASKET	1	1
50205130	R519361	EXHAUST MANIFOLD GASKET	6	6
50202130	R92097	TURBOCHARGING GASKET	1	1
50205247	R521158	OUTLET TURBOCHARGING GASKET	1	1
50205467	R520091	OIL COOLER GASKET	1	1
50205367	R520547	OIL COOLER GASKET		1
50205567	RE524105	OIL COOLER GASKET		1
50205640	R526807	OIL COOLER GASKET		1
50205740	RE516171	OIL COOLER GASKET	2	2
50205830	R518619	GAS RECIRCULATION GASKET	3	3
50201767	R53108	START ENGINE GASKET	1	1
50205967	R119383	INLET WATER PUMP GASKET		1
50206067	R119384	TIMING CASE COVER GASKET		1
50206167	R502011	ALTERNATOR GASKET		1
50206267	R522768	GEARBOX GASKET		1
50206340	R527592	THERMOSTAT GASKET	1	1
RE09135T	RE530121	REAR CRANKSHAFT OIL SEAL		1
RE09136F	RE542195	FRONT CRANKSHAFT OIL SEAL		1
RE09137F	RE529187	VALVE STEM SEAL	24	24

• SOLD SEPARATELY

APPLICATION



JOHN DEERE 6090T 6 CYLINDERS 9.0 LITER TURBO

JOHN DEERE TRACTOR 8245R/8270R 2009/11 8260R 2010/17 8295R/8370R 2015/16 8335R 2011/...8345R 2015/...8320 2008/18

COMBINE W650 2008/15 W660 2008/...S660/S670 2013/17 9670 2010/15 9770 2009/15 CH570/CH670 2015/...3520 2010/15

JOHN DEERE 6090T

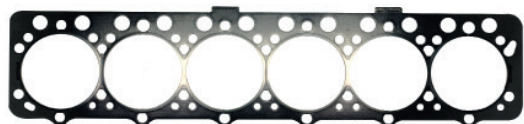

50206067

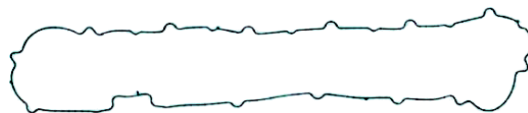

50204540



50206067

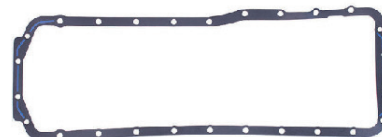

50204767



50206067



50205640



50204947

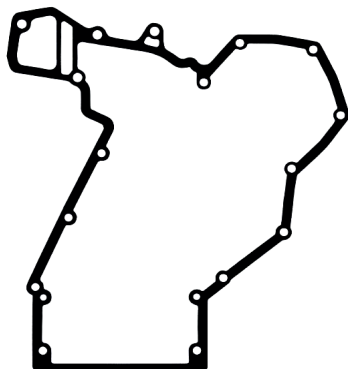

50206067



50205740

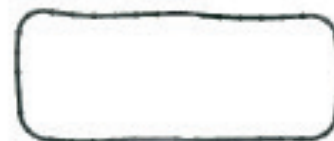

50206340

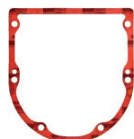

50206267

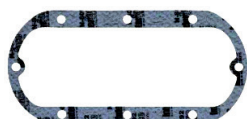

50205567



50205967

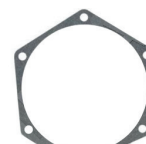

50206167



50205467



50205367



50205247



50201767



50202130



50202130



50204867



50205130



50205830



RE09135T



RE09136F



RE09137F

N° SET		DESCRIPTION		
60210601		FULL GASKET SET JOHN DEERE 6081T WITHOUT OIL SEAL	1	
60230601		HEAD GASKET SET JOHN DEERE 6081T WITHOUT OIL SEAL	2	
N° ABR	N° ORIGINAL	DESCRIPTION		
50206401	R55475	CYLINDER HEAD GASKET	1	1
50206550	R49866	VALVE COVER GASKET	1	1
50204867	R130573	INTAKE MANIFOLD GASKET	3	3
50206667	R88993	INTAKE INTERCOOLER MANIFOLD GASKET	2	2
50206767	R97347	INTAKE INTERCOOLER MANIFOLD GASKET	2	2
50206867	R83020	EXHAUST MONIFOLD GASKET	2	2
50208367	R83021	EXHAUST MONIFOLD GASKET	2	2
50206917	R119384	TIMING CASE COVER GASKET		1
50207017	RE530121	REAR CRANKSHAFT OIL SEAL		1
52161031	RE542195	FRONT CRANKSHAFT OIL SEAL		1
50201867	RE529187	RETENTOR DA HASTE DE VÁLVULA	24	24
50205467	R49377	OIL PAN GASKET		1
50205367	R100569	OIL PAN BREATHER GASKET		1
50205567	R119383	INLET WATER PUMP GASKET		1
50205640	R123570	OUTLET TURBOCHARGING GASKET	1	1
50201767	R123572	TURBOCHARGING GASKET	1	1
50205967	R520547	OIL COOLER GASKET		1
50206067	R520091	OIL COOLER GASKET		1
50206167	RE524105	OIL COOLER GASKET		1
50206267	R526807	OIL COOLER GASKET		1
50207167	R53108	START ENGINE GASKET		1
50207267	R502011	ALTERNATOR GASKET		1
50207367	R522768	GEARBOX GASKET		1
RE09135T	R100911	REAR CRANKSHAFT OIL SEAL	1	1
RE09136F	R119847	OIL FILTER GASKET		1
RE09137F	R109625	VALVE STEM SEAL		1
50207467	R124211	THERMOSTAT GASKET	1	1
50207567	R88397	THERMOSTAT GASKET	2	2
50207640	R124607	THERMOSTAT GASKET	1	1
80200646		KIT RUBBERS	1	1

● SOLD SEPARATELY

APPLICATION

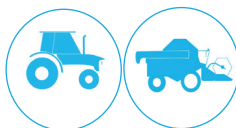

JOHN DEERE TRACTOR 8300 1997/03 8320 2008/12 8400 1998/03 8410 2004/11 8420 2005/11 8430 2007/12

COMBINE 1550 1998/10 1570 2020/15 9650 1998/02 9660 1998/01 9750/9760 2002/11 9780 1999/...3510 2006/10

JOHN DEERE 6081T

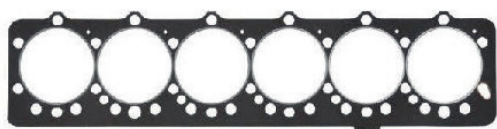

50206401



50206667



50206867



50206550

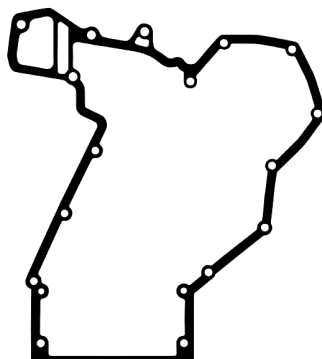

50206067



50208367

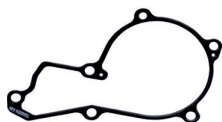

50205967



50206267



50205567

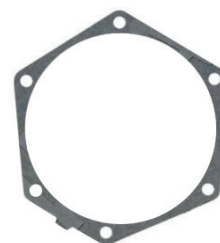

50206167



50201767



50207567



50205640



50207640



50200917



50207167



50207017



50207367



50201867



50207267



52161031



50206767



52161031



50204867



50205367



50205467



RE09136F



RE09137F

N° SET		DESCRIPTION		
60210701		FULL GASKET SET JOHN DEERE 6081T WITHOUT OIL SEAL	1	
60230701		HEAD GASKET SET JOHN DEERE 6081T WITHOUT OIL SEAL	2	
N° ABR	N° ORIGINAL	DESCRIPTION		
50207701	RE47336	CYLINDER HEAD GASKET	1	1
50206550	R49866	VALVE COVER GASKET	1	1
50206767	R130573	INTAKE MANIFOLD GASKET	3	3
50206867	R88993	INTAKE MANIFOLD GASKET	2	2
50206917	R83020	EXHAUST MONIFOLD GASKET	2	2
50207017	R83021	EXHAUST MONIFOLD GASKET	2	2
RE09135T	RE530121	REAR CRANKSHAFT OIL SEAL		1
RE09136F	RE542195	FRONT CRANKSHAFT OIL SEAL		1
RE09137F	RE529187	RETENTOR DO HASTE DA VÁLVULA	24	24
50208167	R71314	TIMING CASE COVER GASKET		1
50208267		TIMING CASE COVER GASKET		1
50208467	R104623	TIMING CASE COVER GASKET		1
50208567	R520543	TIMING CASE COVER GASKET		1
50207867	R520583	OIL PAN GASKET		1
50206667	R49377	OIL PAN GASKET		1
50204867	R100569	OIL PAN BREATHER GASKET		1
50207967	R128557	OIL COOLER GASKET		1
50208067	R128558	OIL COOLER GASKET		1
50207467	R119847	OIL FILTER GASKET		1
50208967	R43774	OIL FILTER GASKET		1
50209467	R520580	WATER PUMP GASKET		1
50209367	R43595	CYLINDER REAR GASKET		1
50207567	R109625	VALVE STEM SEAL		1
50207640	R100911	REAR CRANKSHAFT OIL SEAL	1	1
50208667	R100367	WATER PUMP GASKET		1
50209067	R52049	OIL PUMP GASKET		1
50209167	R97346	INTERCOOLER GASKET		1
50209267	R97348	RETURN TURBOCHARGING GASKET		1
50209567	R93	AUXILIARY DRIVE GASKET		1
52161031	R123572	TURBOCHARGING GASKET	1	1
50201767	R53108	START ENGINE GASKET		1
50201867	R123570	OUTLET TURBOCHARGING GASKET	1	1
50203167	R97350	FUEL PUMP GASKET		1
50205567	RE524105	OIL COOLER GASKET		2
50208867	R50419	OIL COOLER GASKET		1
50206267	R522768	GEARBOX GASKET		1
50207167	R124607	THERMOSTAT GASKET	1	1
50207267	R88397	THERMOSTAT GASKET	2	2
50207367	R124211	THERMOSTAT GASKET	1	1
50209667	R86062	THERMOSTAT GASKET	1	1
80200746		KIT RUBBERS	1	1

● SOLD SEPARATELY

APPLICATION

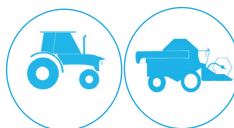

JOHN DEERE TRACTOR 8300 1997/03 8320 2008/12 8400 1998/03 8410 2004/11 8420 2005/11 8430 2007/12

COMBINE 1550 1998/10 1570 2020/15 9650 1998/02 9660 1998/01 9750/9760 2002/11 9780 1999/...3510 2006/10

JOHN DEERE 6076T

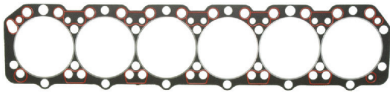

50207701



50206550



50206867

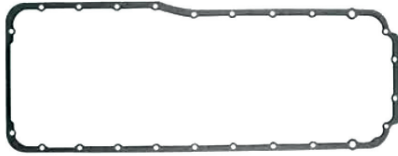

50206667



50207867



50208567

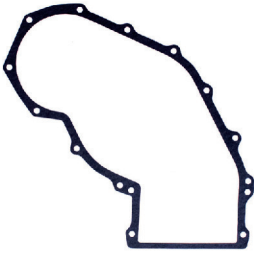

50208567

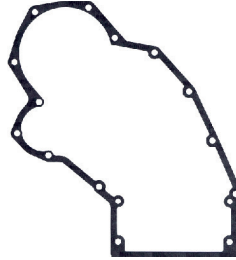

50208467



50207467

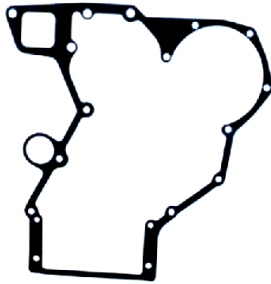

50208167



50208267



50207967



50207567



50208867



50208667



50209067



50208067



50206267

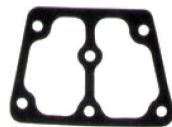

50209367



50207167



50209667



50201767



50209167



50209267



50207017



5020187



50209567



50203167



50204867



50206767



50206917



5216031



50207267



50207640



50207367



52161031



50208967

The image features the Ford logo, which consists of two slanted parallel lines followed by the word "FORD" in a bold, sans-serif font. The entire logo is rendered in a solid blue color. The logo is centered horizontally and vertically within a white rectangular frame defined by blue lines.

FORD

N° ABR	ENGINE	DESCRIPTION	PAGE
64113401	4630	FULL GASKET SET WITHOUT OIL SEAL	244
74113401	4630	FULL GASKET SET WITH OIL SEAL	244
64133401	4630	HEAD GASKET SET WITHOUT OIL SEAL	244
74133401	4630	HEAD GASKET SET WITH OIL SEAL	244
64113301	4600/4610/4810	FULL GASKET SET WITHOUT OIL SEAL	248
74113301	4600/4610/4810	FULL GASKET SET WITH OIL SEAL	248
64133301	4600/4610/4810	HEAD GASKET SET WITHOUT OIL SEAL	248
74133301	4600/4610/4810	HEAD GASKET SET WITH OIL SEAL	248
64113601	F4000/6600/7610	FULL GASKET SET WITHOUT OIL SEAL	252
74113601	F4000/6600/7610	FULL GASKET SET WITH OIL SEAL	252
64133601	F4000/6600/7610	HEAD GASKET SET WITHOUT OIL SEAL	252
6411436	F4000/6600/7610	FULL GASKET SET WITHOUT OIL SEAL	252
64114361	F4000/5610/6600/6610	FULL GASKET SET WITHOUT OIL SEAL	256
64113181	F4000/5610/6600/6610	FULL GASKET SET WITH OIL SEAL	256
74113181	F4000/5610/6600/6610	FULL GASKET SET WITHOUT OIL SEAL	256
64133181	F4000/5610/6600/6610	HEAD GASKET SET WITHOUT OIL SEAL	256
64113651	7630	FULL GASKET SET WITHOUT OIL SEAL	260
74113651	7630	FULL GASKET SET WITH OIL SEAL	260
64133651	7630	FULL GASKET SET WITHOUT OIL SEAL	260
64113501	5030/5630/6630	FULL GASKET SET WITHOUT OIL SEAL	260
74113501	5030/5630/6630	FULL GASKET SET WITH OIL SEAL	260
64133501	7630	FULL GASKET SET WITHOUT OIL SEAL	260
64111093	7830/8030	FULL GASKET SET WITHOUT OIL SEAL	264
74111093	7830/8030	FULL GASKET SET WITH OIL SEAL	264
64133091	7830/8030	HEAD GASKET SET WITHOUT OIL SEAL	264
64111081	PHASE 1	FULL GASKET SET WITHOUT OIL SEAL	266
74111081	PHASE 1	HEAD GASKET SET WITH OIL SEAL	266
64131081	PHASE 1	HEAD GASKET SET WITHOUT OIL SEAL	266
64131061	PHASE 2	HEAD GASKET SET WITHOUT OIL SEAL	266
64111061	PHASE 2	FULL GASKET SET WITHOUT OIL SEAL	266
74111061	PHASE 2	FULL GASKET SET WITH OIL SEAL	266
64115132	TRANSIT 2.4 TDCI	FULL GASKET SET WITHOUT OIL SEAL	270
74115132	TRANSIT 2.4 TDCI	FULL GASKET SET WITH OIL SEAL	270
64135132	TRANSIT 2.4 TDCI	HEAD GASKET SET WITHOUT OIL SEAL	270
74135132	TRANSIT 2.4 TDCI	HEAD GASKET SET WITH OIL SEAL	270
64115142	OUMA 3.2 TDCI	FULL GASKET SET WITHOUT OIL SEAL	272
74115142	OUMA 3.2 TDCI	FULL GASKET SET WITH OIL SEAL	272
64135142	OUMA 3.2 TDCI	HEAD GASKET SET WITHOUT OIL SEAL	272
74135142	OUMA 3.2 TDCI	HEAD GASKET SET WITH OIL SEAL	272
74115282	TRANSIT 2.2	FULL GASKET SET WITH OIL SEAL	274
74118282	TRANSIT 2.2	FULL GASKET SET WITH OIL SEAL	274

N° SET		DESCRIPTION				
64113401	FULL GASKET SET FORD 4630 3 CYLINDERS SERIE 30 WITHOUT OIL SEAL		1			
74113401	FULL GASKET SET FORD 4630 3 CYLINDERS SERIE 30 WITH OIL SEAL		2			
64133401	HEAD GASKET SET FORD 4630 3 CYLINDERS SERIE 30 WITHOUT OIL SEAL		3			
74133401	HEAD GASKET SET FORD 4630 3 CYLINDERS SERIE 30 WITH OIL SEAL		4			
N° ABR	N° ORIGINAL	DESCRIPTION				
50051067	D3NN6336A	GASKET				
54103841	C5NE6571A	VALVE STEM SEAL	6	6	6	6
54128701	D8NN6051AA	CYLINDER HEAD GASKET				
54134150		OIL SEAL GASKET DO INJETOR	3	3	3	3
54134298		THERMOSTATIC GASKET				
54134398	C7NN9435B	INTAKE MANIFOLD GASKET				
54134416	C5NN9435B	EXHAUST MANIFOLD GASKET	1	1	1	1
54134550		VALVE COVER GASKET	1	1	1	1
54134798		OIL PUMP GASKET				
54134890	60,5 X 82,5	NOZZLE GASKET				
54134966		GASKET				
54135090		WATER PUMP GASKET				
54135190	C5NE8507A	WATER PUMP BODY GASKET				
54135290	C5NE9F598	WATER PUMP GASKET				
54135390	C7NN6N008B	FRONT COVER GASKET				
54135454	C5NE6N008B	OIL SEAL COVER GASKET				
54135590	C5NE6C045A	REAR TIMING CASE COVER GASKET				
54135690	C5NE6020A	FRONT TIMING CASE COVER GASKET				
54169267		OIL PAN GASKET (SECTIONED)				
54149016	D3NN56250A	OUTLET EXHAUST GASKET				
54150690	D3NN9439A	INTAKE MANIFOLD GASKET	1	1	1	1
54152798		OIL SEAL GASKET				
54154098		OIL SEAL GASKET				
54161550	E5HN6N305C	REAR PLATE GASKET				
54166898		WATER PUMP GASKET				
54168167	E9NN6N105BB	OIL SEAL COVER GASKET				
54168200	E8NN6051AA	CYLINDER HEAD GASKET	1	1	1	1
54153750		THERMOSTATIC GASKET				
84168340		KIT HEAD WASHERS AND RUBBERS				
84169140		KIT WASHERS AND RUBBERS				
84169740		KIT HEAD WASHERS AND RUBBERS	1	1	1	1
84170890		KIT HEAD WASHERS AND RUBBERS				
RE02448S	84170890	FRONT OIL SEAL	1	1	1	1
RE02449S		REAR OIL SEAL	1	1	1	1

● SOLD SEPARATELY

APPLICATION



FORD BSD333 SERIES 10 3 CYL. 3.3L

FORD TRACTOR 4600 1975/99, 4610 1984/99

FORD GENESIS SERIES 30 3 CYL. 3.3L

FORD TRACTOR 4630 1993/98



FORD 4600/4630 SERIE 30



54128701



54168200



54134398



54134416



54134550

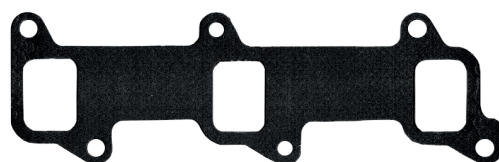

54134416

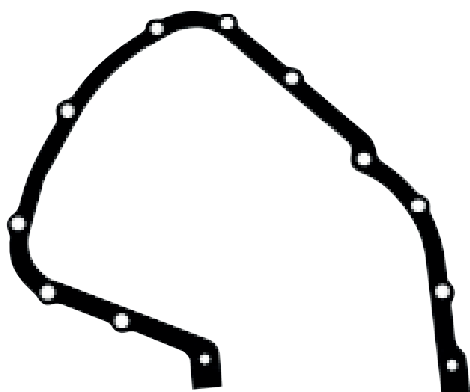

54168167



54135590

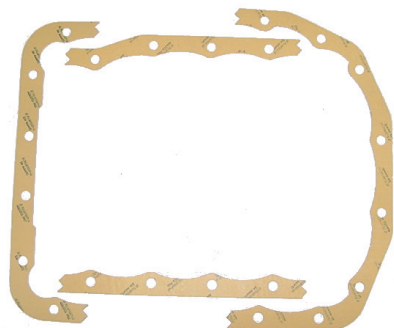

54169267

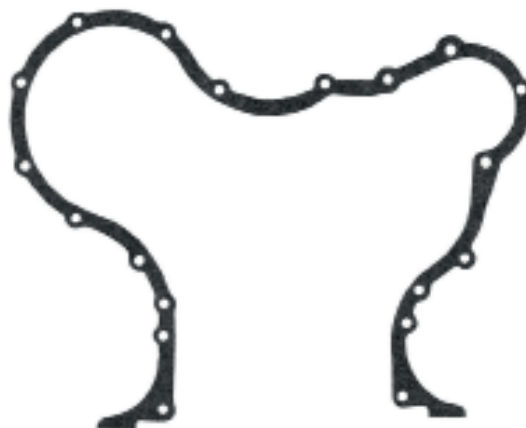

54135690

FORD 4600/4630 SERIE 30



54167947



54134798



54134298

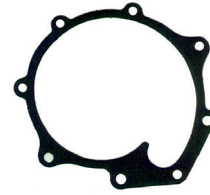

54166898



54149016

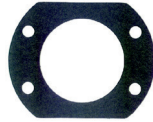

54152798



54135190

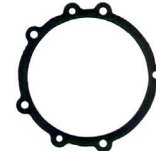

RE02629F



54135090



54153750



54514098

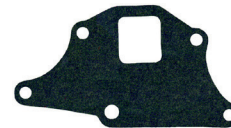

54154098



RE02449S



RE02448S



54134890

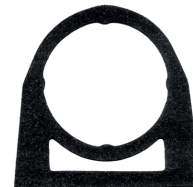

54135454



54161550



54134966



50051067



54134150



54103841

84168340 KIT RUBBERS		
N° ABR	DESCRIPTION	QTD
50003741	WASHERS RUBBER 7,3 X 11,7 X 2,0 MM	3
50009041	SEAL 57,0 X 3,5 MM	1
50011528	ALUMINUM WASHERS 8,0 X 12,0 X 1,0 MM	7
50013824	INJECTOR NOZZLE WASHERS	3
50027341	SEAL 81,5 X 2,5 MM	1
50027366	WASHERS PH 20,5 X 25,9 X 2,0 MM	1
50029041	SEAL 133,0 X 3,3 MM	1
50070166	WASHERS FB 24,0 X 31,0 X 1,5 MM	1

84170890 KIT RUBBERS		
N° ABR	DESCRIPTION	QTD
50003741	WASHERS RUBBERS 7,3 X 11,7 X 2,0 MM	3
50013824	INJECTOR NOZZLE WASHERS	3

84169140 KIT RUBBERS		
N° ABR	DESCRIPTION	QTD
50003741	WASHERS RUBBERS 7,3 X 11,7 X 2,0 MM	3
50009041	SEAL 57,0 X 3,5 MM	3
50011528	ALUMINUM WASHER 8,0 X 12,0 X 1,0 MM	7
50013824	INJECTOR NOZZLE WASHERS	3
50027341	SEAL 81,5 X 2,5 MM	1
50027366	WASHERS PH 20,5 X 25,9 X 2,0 MM	1
50029041	SEAL 133,0 X 3,3 MM	1

84169740 KIT RUBBERS		
N° ABR	DESCRIPTION	QTD
50003741	WASHERS RUBBERS 7,3 X 11,7 X 2,0 MM	3
50013824	INJECTOR NOZZLE WASHERS	3

FORD 4600/4610/4810 SERIE 10

N° SET		DESCRIPTION				
64113301		FULL GASKET SET FORD 4600/4610/4810 SERIE 10 WITHOUT OIL SEAL	1			
74113301		FULL GASKET SET FORD 4600/4610/4810 SERIE 10 WITH OIL SEAL	2			
64133301		HEAD GASKET SET FORD 4600/4610/4810 SERIE 10 WITHOUT OIL SEAL	3			
74133301		HEAD GASKET SET FORD 4600/4610/4810 SERIE 10 WITH OIL SEAL	4			
N° ABR	N° ORIGINAL	DESCRIPTION				
50051067	D3NN6336A	GASKET			2	2
54103841	C5NE6571A	VALVE STEM SEAL	6	6	6	6
54128701	D8NN6051AA	CYLINDER HEAD GASKET	1	1	1	1
54134150		OIL SEAL GASKET DO INJETOR	3	3	3	3
54134298		THERMOSTATIC GASKET		1	1	
54134398	C7NN9435B	INTAKE MANIFOLD GASKET	1	1	1	1
54134416	C5NN9435B	EXHAUST MANIFOLD GASKET	1	1	1	1
54134550		VALVE COVER GASKET	1	1	1	1
54134798		OIL PUMP GASKET			1	1
54134890	60,5 X 82,5	NOZZLE GASKET			1	1
54134966		GASKET			1	1
54135090		WATER PUMP GASKET			1	1
54135190	C5NE8507A	WATER PUMP BODY GASKET			1	1
54135290	C5NE9F598	WATER PUMP GASKET			1	1
54135390	C7NN6N008B	FRONT COVER GASKET			1	1
54135454	C5NE6N008B	OIL SEAL COVER GASKET			1	1
54135590	C5NE6C045A	REAR TIMING CASE COVER GASKET			1	1
54135690	C5NE6020A	FONT TIMING CASE COVER GASKET			1	1
54169267		OIL PAN GASKET (SECTIONED)			1	1
54149016	D3NN56250A	OUTLET EXHAUST GASKET	1	1	1	1
54150690	D3NN9439A	INTAKE MANIFOLD GASKET			1	1
54152798		OIL SEAL GASKET			1	1
54154098		OIL SEAL GASKET			1	1
54161550	E5HN6N305C	REAR PLATE GASKET			1	1
54166898		WATER PUMP GASKET				
54168167	E9NN6N105BB	OIL SEAL COVER GASKET	1			
54168200	E8NN6051AA	CYLINDER HEAD GASKET			1	1
54153750		THERMOSTATIC GASKET			1	1
84168340		KIT HEAD WASHERS AND RUBBERS				
84169140		KIT WASHERS AND RUBBERS				
84169740		KIT HEAD WASHERS AND RUBBERS	1			
84170890		KIT HEAD WASHERS AND RUBBERS		1		
RE02448S	84170890	FRONT OIL SEAL	1		1	
RE02449S		REAR OIL SEAL	1		1	

● SOLD SEPARATELY

APPLICATION



FORD BSD333 SERIES 10 3 CYLINDERS 3.3LITERS

FORD TRACTOR 4600 1975/99, 4610 1984/99

FORD GENESIS SERIES 30 3 CYLINDERS 3.3LITERS

FORD TRATOR 4630 1993/98



FORD 4600/4610/4810 SERIE 10



54128701

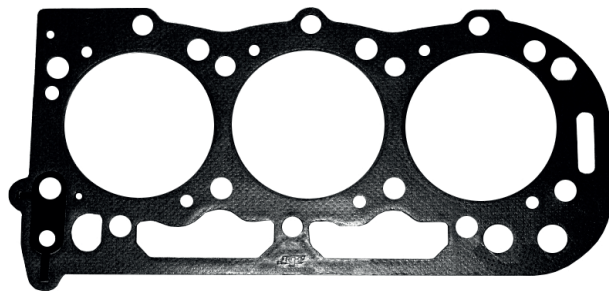

54168200



54134398



54134416



54134550

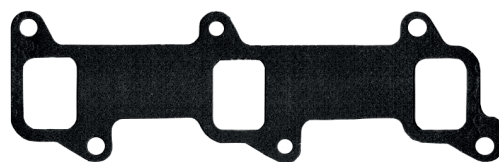

54134416

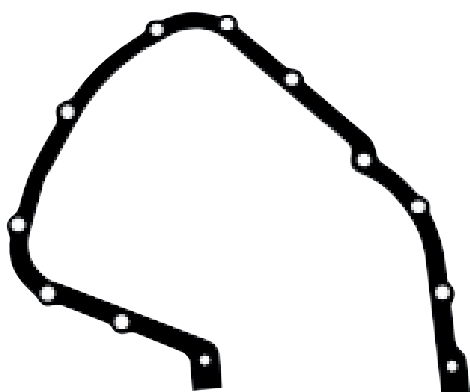

54168167



54135590

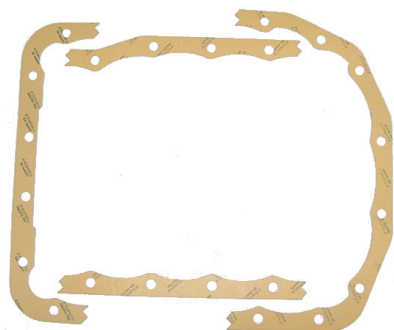

54169267

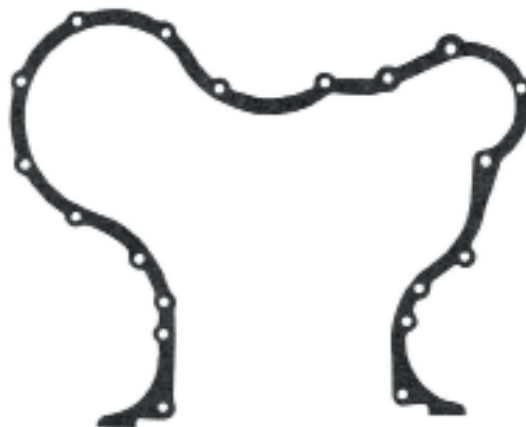

54135690

FORD 4600/4610/4810 SERIE 10



54167947



54134798



54134298

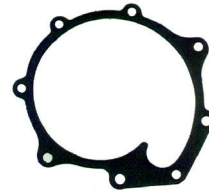

54166898



54149016

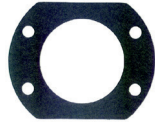

54152798



54135190

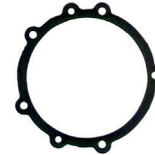

RE02629F



54135090



54153750



54514098



54154098



RE02449S



RE02448S



54134890

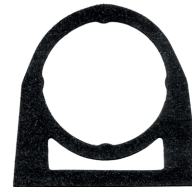

54135454



54161550



54134966



50051067



54134150



54103841

84168340 KIT RUBBERS

N° ABR	DESCRIPTION	QTD
50003741	WASHERS RUBBERS 7,3 X 11,7 X 2,0 MM	3
50009041	SEAL 57,0 X 3,5 MM	1
50011528	ALUMINUM WASHER 8,0 X 12,0 X 1,0 MM	7
50013824	INJECTOR NOZZLE WASHERS	3
50027341	SEAL 81,5 X 2,5 MM	1
50027366	WASHERS PH 20,5 X 25,9 X 2,0 MM	1
50029041	SEAL 133,0 X 3,3 MM	1
50070166	WASHERS FB 24,0 X 31,0 X 1,5 MM	1

84170890 KIT RUBBERS

N° ABR	DESCRIPTION	QTD
50003741	WASHERS RUBBERS 7,3 X 11,7 X 2,0 MM	3
50013824	INJECTOR NOZZLE WASHERS	3

84169140 KIT RUBBERS

N° ABR	DESCRIPTION	QTD
50003741	WASHERS RUBBERS 7,3 X 11,7 X 2,0 MM	3
50009041	SEAL 57,0 X 3,5 MM	3
50011528	ALUMINUM WASHER 8,0 X 12,0 X 1,0 MM	7
50013824	INJECTOR NOZZLE WASHERS	3
50027341	SEAL 81,5 X 2,5 MM	1
50027366	WASHERS PH 20,5 X 25,9 X 2,0 MM	1
50029041	SEAL 133,0 X 3,3 MM	1

84169740 KIT RUBBERS

N° ABR	DESCRIPTION	QTD
50003741	WASHERS RUBBERS 7,3 X 11,7 X 2,0 MM	3
50013824	INJECTOR NOZZLE WASHERS	3

N° SET	DESCRIPTION	
64113601	FULL GASKET SET FORD 7610 4 CYLINDERS SERIE 10 WITHOUT OIL SEAL	1
74113601	FULL GASKET SET FORD 7610 4 CYLINDERS SERIE 10 WITH OIL SEAL	2
64133601	HEAD GASKET SET FORD 7610 4 CYLINDERS SERIE 10 WITHOUT OIL SEAL	3
64114361	FULL GASKET SET FORD F4000 MT FNH WITHOUT OIL SEAL	4

N° ABR	N° ORIGINAL	DESCRIPTION				
50051067	D3NN6336A	GASKET	2			
52111731		TURBOCHARGING GASKET		1	1	1
54103841	C5NE6571A	VALVE STEM SEAL	8	8	8	8
54127201	E0NN6051A	CYLINDER HEAD GASKET	1	1	1	1
54134150		OIL SEAL GASKET DO INJETOR	4	4	4	4
54134298		THERMOSTATIC GASKET	1		1	1
54134798		OIL PUMP GASKET DO CARTER	1		1	1
54134890	60,5X82,5	NOZZLE GASKET	1			
54134966		GASKET	1			
54135090		WATER PUMP GASKET	1	1	1	1
54135190	C5NE8507A	WATER PUMP BODY GASKET	1			
54135290	C5NE9F598	WATER PUMP GASKET	1		1	1
54135390	C7NN6N008B	FRONT COVER GASKET	1		1	1
54135454	C5NE6C045A	OIL SEAL COVER GASKET	1			
54135590	C5NE6020A	REAR TIMING CASE COVER GASKET	1		1	1
54135690	C7NN6584C	FONT TIMING CASE COVER GASKET	1		1	1
54137150		VALVE COVER GASKET	1	1	1	1
54139090	C5NE9448B	INTAKE MANIFOLD GASKET				
54139116		EXHAUST MANIFOLD GASKET	1	1	1	1
54169367	D4NN6710A	OIL PAN GASKET	1			
54139296	D3NN56250A	OIL PAN GASKET			1	1
54149016	D3NN9439B	OUTLEK EXHAUST GASKET	1	1	1	1
54150790	E1TN9439BA	INTAKE MANIFOLD GASKET				
54152198		INTAKE MANIFOLD GASKET	1			
54152798		OIL SEAL GASKET	1			
54153750	C5NE8507A	THERMOSTATIC GASKET	1			
54154098		WATER PUMP GASKET	1			
54155596	E5HN6N40AA	OIL RETURN GASKET	1	1	1	1
54155631		TURBOCHARGING GASKET	1	1	1	1
54155798	E5HN6N305C	INLET OIL GASKET	1	1	1	1
54161550		REAR PLATE GASKET	1		1	1
54166898		WATER PUMP GASKET	1		1	1
54167947		OUTLET EXHAUST GASKET		1	1	1
54169167		INTAKE MANIFOLD GASKET		1	1	1
84168240		KIT WASHERS AND RUBBERS	1			
84169540		KIT WASHERS AND RUBBERS			1	1
84170140		KIT HEAD WASHERS AND RUBBERS		1		
RE02448S		FRONT OIL SEAL				1
RE02449S		REAR OIL SEAL				1

● SOLD SEPARATELY



APPLICATION

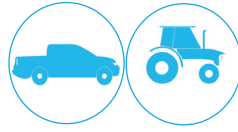

FORD BSD444 SERIES 10 4 CYLINDERS. 4.4 LITERS

FORD TRACTOR 6600 1978/98 ; 5610/6610/6710 1984/98 ; 7610 1985/00

FORD FNH 268 4 CYLINDERS 4.4LITERS

FORD PICK-UP F2000/F4000 1982/89

FORD BSD444T SERIES 10 4 CYLINDERS 4.4LITERS

FORD TRACTOR 7610 1985/00

FORD F4000/6600/7610



50965504

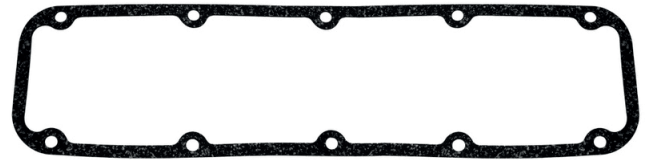

50918655

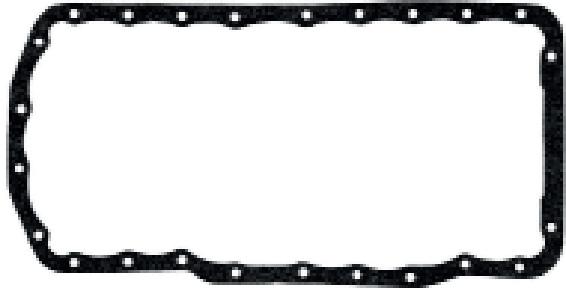

50965504

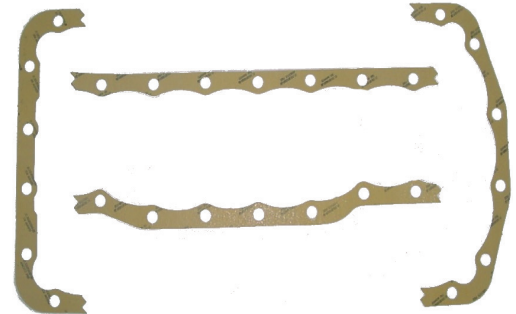

50918655



50965504

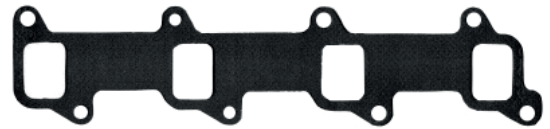

50918655



50965504



50918655



50965504



54370867

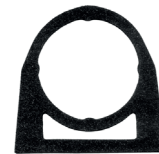

58311632

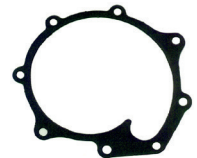

RE02629F



5437067



54370867



58311632



RE02629F

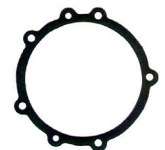

RE02629F



5437067



54370867



58311632



RE02629F



RE02629F



5437067



54370867



58311632

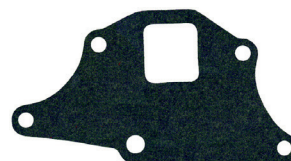

RE02629F



RE02629F

N° SET		DESCRIPTION			
64114361	FULL GASKET SET FORD F4000 MT FNH 268 4 CYLINDERS WITHOUT OIL SEAL		1		
64113181	FULL GASKET SET FORD 5610/6600/6610 4 CYLINDERS SERIE 10 WITHOUT OIL SEAL		2		
74113181	FULL GASKET SET FORD 5610/6600/6610 4 CYLINDERS SERIE 10 WITH OIL SEAL		3		
64133181	HEAD GASKET SET FORD 5610/6600/6610 4 CYLINDERS SERIE 10 WITHOUT OIL SEAL		4		
N° ABR	N° ORIGINAL	DESCRIPTION			
50051067	D3NN6336A	GASKET	2	2	2
52111731		TURBOCHARGING GASKET			
54103841	C5NE6571A	VALVE STEM SEAL	8	8	8
54127201	E0NN6051A	CYLINDER HEAD GASKET	1	1	1
54134150		OIL SEAL GASKET DO INJETOR	4	4	4
54134298		THERMOSTATIC GASKET	1	1	1
54134798		OIL PUMP GASKET DO CARTER	1	1	1
54134890	60,5X82,5	NOZZLE GASKET	1	1	1
54134966		GASKET	1	1	1
54135090		WATER PUMP GASKET	1	1	1
54135190	C5NE8507A	WATER PUMP BODY GASKET	1	1	1
54135290	C5NE9F598	WATER PUMP GASKET	1	1	1
54135390	C7NN6N008B	FRONT COVER GASKET	1	1	1
54135454	C5NE6C045A	OIL SEAL COVER GASKET	1	1	1
54135590	C5NE6020A	REAR TIMING CASE COVER GASKET	1	1	1
54135690	C7NN6584C	FONT TIMING CASE COVER GASKET	1	1	1
54137150		VALVE COVER GASKET	1	1	1
54139090	C5NE9448B	INTAKE MANIFOLD GASKET	1	1	1
54139116		EXHAUST MANIFOLD GASKET	1	1	1
54169367	D4NN6710A	OIL PAN GASKET			1
54139296	D3NN56250A	OIL PAN GASKET	1	1	
54149016	D3NN9439B	OUTLEK EXHAUST GASKET	1	1	1
54150790	E1TN9439BA	INTAKE MANIFOLD GASKET	1	1	1
54152198		INTAKE MANIFOLD GASKET			1
54152798		OIL SEAL GASKET	1	1	1
54153750	C5NE8507A	THERMOSTATIC GASKET	1	1	1
54154098		WATER PUMP GASKET	1	1	1
54155596	E5HN6N40AA	OIL RETURN GASKET			1
54155631		TURBOCHARGING GASKET			1
54155798	E5HN6N305C	INLET OIL GASKET			1
54161550		REAR PLATE GASKET	1	1	1
54166898		WATER PUMP GASKET	1	1	1
54167947		OUTLET EXHAUST GASKET			
54169167		INTAKE MANIFOLD GASKET			
84168240		KIT WASHERS AND RUBBERS	1	1	1
84169540		KIT WASHERS AND RUBBERS			
84170140		KIT HEAD WASHERS AND RUBBERS	1		
RE02448S		FRONT OIL SEAL	1		1
RE02449S		REAR OIL SEAL	1		1

● SOLD SEPARATELY



FORD F4000/5610/6600/6610

APPLICATION

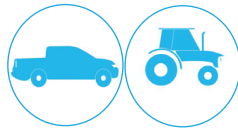

FORD BSD444 SERIES 10 4 CYLINDERS 4.4LITERS

FORD TRACTOR 6600 1978/98 ; 5610/6610/6710 1984/98 ; 7610 1985/00

FORD FNH 268 4 CYLINDERS 4.4LITERS

FORD PICK-UP F2000/F4000 1982/89

FORD BSD444T SERIES 10 4 CYLINDERS 4.4LITERS

FORD TRACTOR 7610 1985/00

FORD F4000/5610/6600/6610



50965504

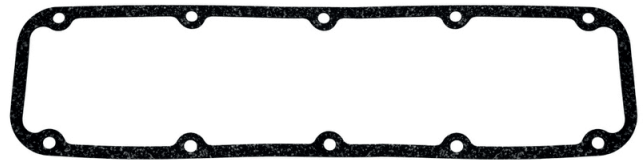

50918655

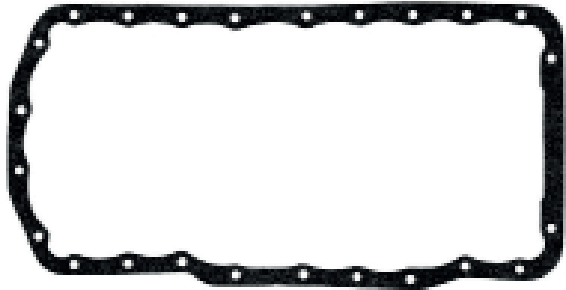

50965504

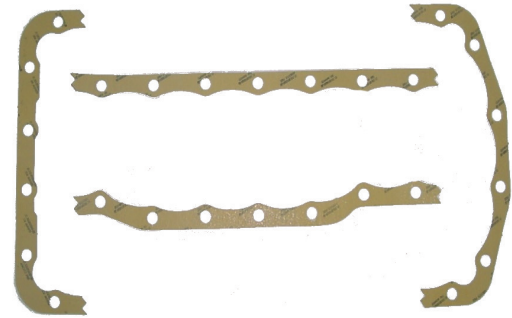

50918655



50965504

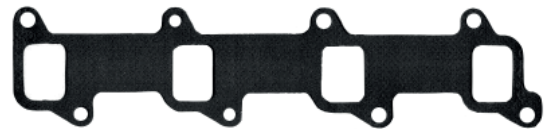

50918655



50965504



50918655



50965504



54370867

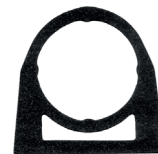

58311632

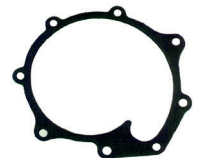

RE02629F



5437067



54370867



58311632



RE02629F

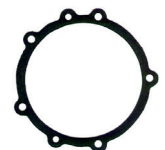

RE02629F



5437067



54370867



58311632



RE02629F



RE02629F



5437067



54370867



58311632

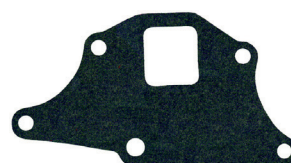

RE02629F



RE02629F

FORD 5630/6630/7630 4 CYLINDERS

Nº SET	DESCRIPTION
64113651	FULL GASKET SET 7630 4 CYLINDERS SERIE30 WITHOUT OIL SEAL
74113651	FULL GASKET SET 7630 4 CYLINDERS SERIE 30 WITH OIL SEAL
64133651	FULL GASKET SET 7630 COM RETIFICA VALVES 4 CYLINDERS SERIE 30 WITHOUT OIL SEAL
64113501	FULL GASKET SET 5030/5630/6630 4 CYLINDERS SERIE 30 WITHOUT OIL SEAL
74113501	FULL GASKET SET 5030/5630/6630 4 CYLINDERS SERIE 30 WITH OIL SEAL
64133501	FULL GASKET SET 7630 COM RETIFICA VÁLVULA 4 CYLINDERS SERIE 30 WITHOUT OIL SEAL

Nº ABR	Nº ORIGINAL	DESCRIPTION	1	2	3	4	5	6
52111731		TURBOCHARGING GASKET	1	1	1	1	1	1
54103841	C5NE6571A	VALVE STEM SEAL	8	8	8	8	8	8
54134150		INJECTION PUMP GASKET	4	4	4	4	4	4
54134298		THERMOSTATIC GASKET		1	1		1	1
54134798		OIL PAN PUMP GASKET		1	1		1	1
54134890		NOZZLE GASKET		1	1		1	1
54135090		WATER PUMP GASKET						1
54135190		WATER PUMP BODY GASKET		1	1		1	1
54135290	C5NE8507A	WATER PUMP GASKET		1	1		1	1
54135390	C5NE9F598	FRONT COVER GASKET		1	1		1	1
54135590	C5NE6C045A	REAR TIMING CASE COVER GASKET		1	1	1	1	1
54135690	CSNE6020A	FRONT TIMING CASE COVER GASKET		1	1	1	1	1
54137150	C7NN6584C	VALVE COVER GASKET	1	1	1	1	1	1
54169337	541169337	OIL PAN GASKET		1	1	1	1	1
54149016	D3NN56250A	OUTLET EXHAUST GASKET	1	1	1	1	1	1
54153750		THERMOSTATIC GASKET		1	1		1	1
54155596		OIL RETURN GASKET DA TURBINA	1	1	1	1	1	1
54155631	ESHN6N640AA	TURBOCHARGING GASKET					1	1
54155798		INLET OIL GASKET DA TURBINA	1	1	1	1	1	1
54166898		WATER PUMP GASKET		1	1		1	1
54167647	E9NN94488A	EXHAUST MANIFOLD GASKET	1	1	1	1	1	1
54168067	F0NN9439AA	INTAKE MANIFOLD GASKET	1	1	1	1	1	1
54168167	E9NN6N105BB	OIL SEAL COVER GASKET		1	1		1	1
54168300	F1NN6051BA	CYLINDER HEAD GASKET	1	1	1	1	1	1
84169340		KIT WASHERS AND RUBBERS		1	1		1	1
84169326	84169326	KIT HEAD WASHERS AND RUBBERS	1	1				
RE02448S	RE02448S	FRONT OIL SEAL				1		1
RE02449S	RE02449S	REAR OIL SEAL				1		1
54139090		INTAKE MANIFOLD GASKET	1	1	1	1	1	1

• SOLD SEPARATELY

APPLICATION



FORD TRACTOR 5030/5630/6630 1993/98

FIAT TRACTOR FB80.2 1996/...

FORD TRACTOR 7630 1995/07 TS100/110 1999/08 TS90 1999/09



FORD 5630/6630/7630 4 CYLINDERS

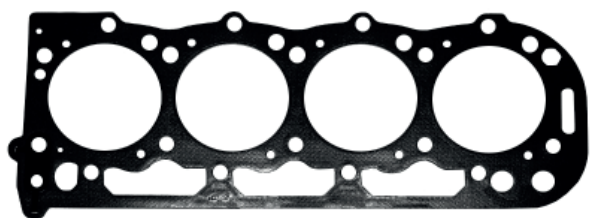

54168300



54137150

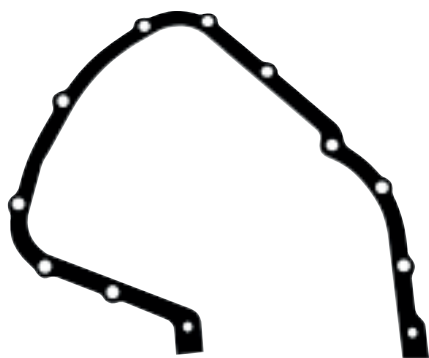

54168167

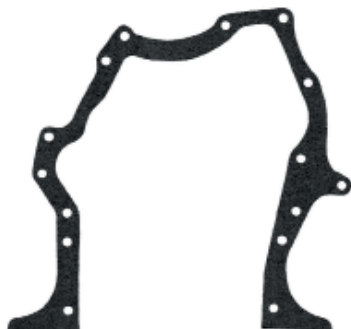

54135590

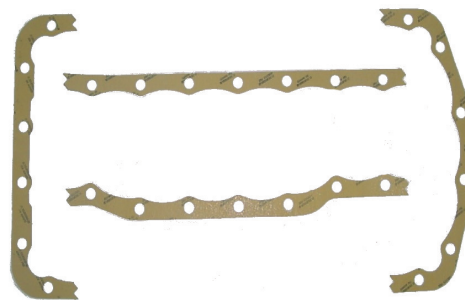

54169367



54168067



54139090



54167647

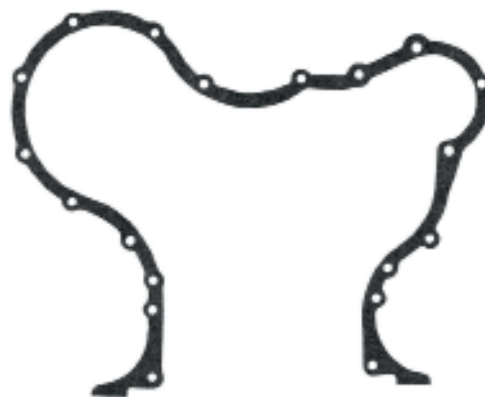

54135690



54155798



54155596



54134798



54149016



54134298



54135190



52111731



54155631



54135290

FORD 5630/6630/7630 4 CYLINDERS



54135090



54153750

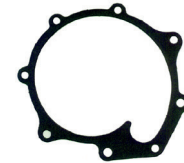

541666898

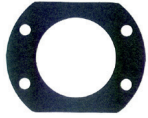

54152798



54134966

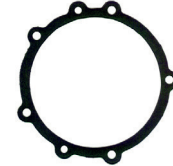

54135390



RE02449S



RE02448S



54134890



50051067



54134150



54103841

84170140 KIT RUBBERS		
Nº ABR	DESCRIPTION	QTD
50003741	WASHERS RUBBERSRACHA 7,3X11,7X2,0 MM	4
50070166	INJECTOR NOZZLE WASHERS	4

84168240 KIT RUBBERS		
Nº ABR	DESCRIPTION	QTD
50003741	WASHERS RUBBERS 7,3X11,7X2,0 MM	4
50009041	SEAL 57,0X3,5 MM	1
50011528	ALUMINUM WASHER 8,0X12,0X1,0 MM	8
50013824	INJECTOR NOZZLE WASHERS	4
50015428	ALUMINUM WASHER 10,0X14,0X1,0 MM	1
50017696	WASHERS PH 11,4X17,9X1,6 MM	4
50027341	SEAL 81,5X2,5 MM	1
50027366	WASHERS PH 20,5X25,9X2,0 MM	4
50029041	SEAL 133,0X3,3 MM	1
50051050	WASHERS CE 21,5X32,5X1,0 MM	4
50070166	WASHERS FB 24,0X31,0X1,5 MM	1

84169740 KIT RUBBERS		
Nº ABR	DESCRIPTION	QTD
50003741	WASHERS RUBBERS 7,3X11,7X2,0 MM	3
50009041	SEAL 57,0X3,5 MM	3
50011528	WASHERS DE ALUMINIO 8,0X12,0X1,0 MM	7
50013824	INJECTOR NOZZLE WASHERS	3
50027341	SEAL 81,5X2,5 MM	1
50027366	WASHERS PH 20,5X25,9X2,0 MM	1
50029041	SEAL 133,0X3,3 MM	1

7830/8030 6 CYLINDERS

N° SET		DESCRIPTION			
64111093	FULL GASKET SET FORD 7830/8030 6 CYLINDERS WITHOUT OIL SEAL		1		
74111093	FULL GASKET SET FORD 7830/8030 6 CYLINDERS WITH OIL SEAL		2		
64133091	HEAD GASKET SET FORD 7830/8030 6 CYLINDERS WITHOUT OIL SEAL		3		
N° ABR	N° ORIGINAL	DESCRIPTION			
52111731		TURBOCHARGING GASKET	1	1	1
54168167	E9NN6N105BB	OIL SEAL COVER GASKET		1	1
54103841	C5NR6571A	VALVE STEM SEAL			
54135690	C5NE6020A	FRONT COVER GASKET	1	1	
54135590	C5NE6C045A	REAR COVER GASKET	1	1	
54135290	C5NE8507A	WATER PUMP GASKET	1	1	
54135390	C5NE9F598	FRONT COVER GASKET	1	1	
54134150		INJECTOR SEAL	6	6	6
54134798		OIL PAN PUMP GASKET	1	1	
54155596		OIL RETURN GASKET DA TURBINA	1	1	1
54155798		INLET OIL GASKET DA TURBINA	1	1	1
54154098	C5NE8507A	WATER PUMP GASKET	1	1	
54154570	ESHN8507AA	WATER PUMP GASKET	1	1	
54166898		WATER PUMP GASKET	1	1	
54153750		THERMOSTATIC GASKET	1	1	
54152450	ESHN6584AA	VALVE COVER GASKET	1	1	
54167718	E9NN9448AA	EXHAUST MANIFOLD GASKET	1	1	1
54167867		INTAKE MANIFOLD GASKET	2	2	2
54172301	E9HN6051BA	CYLINDER HEAD GASKET	1	1	1
54169567	E3HN6710AA	OIL PAN GASKET			
84168840		KIT WASHERS AND RUBBERS	1	1	
84168826		KIT WASHERS AND RUBBERS	1	1	
RE02448S		FRONT OIL SEAL			1
RE02449S		REAR OIL SEAL			1
54134298		THERMOSTATIC OIL SEAL	1	1	

● SOLD SEPARATELY

APPLICATION



FORD TRACTOR 7830 1993/98 8030 1993/07 TM120/130/135/150 2000/08 TM140 1998/08 TM165/180 2001/08 TS120 1999/08

7830/8030 6 CYLINDERS

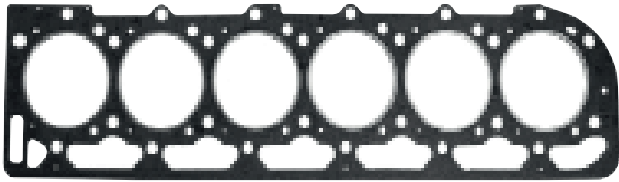

54172301



54152450



54167867

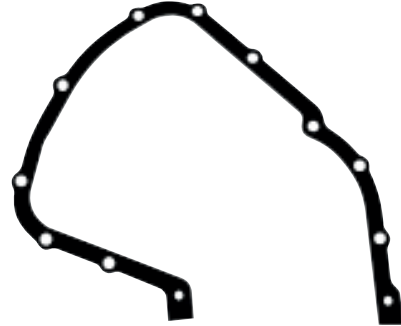

54168167

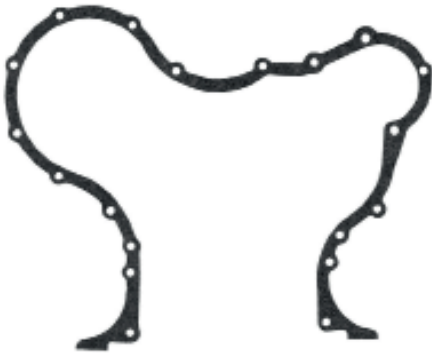

54135690



54135590



54167718



54154098



54154570

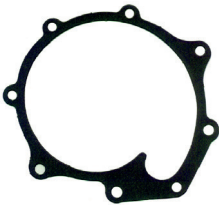

54166898



54135290



54153750



54134798



54134298



54134150



54103841

FORD CARGO PHASE I / II 6

Nº SET	DESCRIPTION
64111081	FULL GASKET SET PHASE I 6 CYLINDERS WITHOUT OIL SEAL
74111081	HEAD GASKET SET PHASE I 6 CYLINDERS WITH OIL SEAL
64131081	HEAD GASKET SET PHASE I 6 CYLINDERS WITHOUT OIL SEAL
64131061	HEAD GASKET SET PHASE II 6 CYLINDERS WITHOUT OIL SEAL
64111061	FULL GASKET SET PHASE II 6 CYLINDERS WITHOUT OIL SEAL
74111061	FULL GASKET SET PHASE II 6 CYLINDERS WITH OIL SEAL

Nº ABR	Nº ORIGINAL	DESCRIPTION	1	2	3	4	5	6
50005449		FRNT OIL SEAL	1					
50051067	D3NN633A	GASKET	2	2				2 2
54103841	CSNE6571A	VALVE STEM SEAL	12	12	12	12	12	12
54134150		INJECTOR GASKET	6	6	6	6	6	6
54134416	C5NE9448A	EXHAUST MANIFOLD GASKET				2	2	2
54134973	60,5X82,5	GASKET	1	1				1 1
54135454	C7NN6N008B	OIL SEAL COVER GASKET	1	1				1 1
54135590	C5NE6C051A	TIMING CASE COVER GASKET	1	1				1 1
54152203	E7HN6051AA	CYLINDER HEAD GASKET	1	1	1	1	1	1 1
54152390	E3HN9439AA	INTAKE MANIFOLD GASKET					1	1 1
54152450	E5HN6584AA	VALVE COVER GASKET	1	1	1	1	1	1 1
54152550	E3HN6710AA	OIL PAN GASKET	1	1				1 1
54153898	E5HN6020AB	TIMING CASE COVER GASKET	1	1				
54154216	E5HN9448AB	INTAKE MANIFOLD GASKET	2	2	2			
54154570	E5HN8507AA	WATER PUMP GASKET	1	1				1 1
54154683		FUEL PUMP GASKET	1	1				1 1
54154952		INJECTION EXHAUST GASKET	1	1				1 1
54155498		WATER PUMP BODY GASKET	1	1				1 1
54155596		OIL RETURN GASKET	1	1	1	1	1	1 1
54155631	E5HN6N640AA	TURBOCHARGING GASKET	1	1	1	1	1	1 1
54155798		INLET OIL GASKET	1	1	1	1	1	1 1
54159998	E5HN9439AA	INTAKE MANIFOLD GASKET	1	1	1			
54161398	E3HN6020AA	TIMING CASE COVER GASKET						1 1
54161550	E5HN6N305C	REAR PLATE GASKET	1	1				1 1
84168040		KIT WASHERS AND RUBBERS	1	1				1 1
84168026		KIT HEAD WASHERS AND RUBBERS			1	1		
RE02448S		FRONT OIL SEAL						1
RE02449S		REAR OIL SEAL	1					1

• SOLD SEPARATELY

APPLICATION



FORD FTO 6 CYL.6.6L(PHASE I)TURBO

FORD TRUCK C-1113/C-1114/C-1117/C-1313/C-1314/C-1317 1985/89 C-1215/C-1218/C-1415/C-1617 1985/91 C-1418/C-1615 1985/90 C-1517 1985/89 C-2217 1985/86

FORD FTO 6 CYL.7.8L(PHASE II)TURBO

FORD TRUCK C-1419/C-1519 1990/92 C-1618 1988/91 C-1619 1988/90 C-1624 1990/90 C-2218 1988/90 C-2319 1990/90 C-2324 1990/91 C-3224 1989/91



FORD CARGO PHASE I / II 6 CYLINDERS



54152203



54152450



54159998



54152390

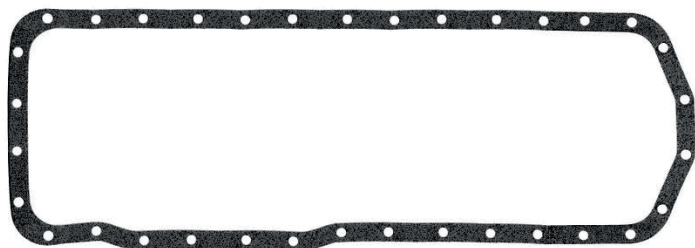

54152550



54135590



54161398



54153898



54154216



54134416

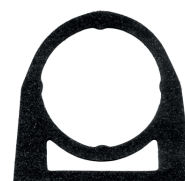

54135454



54154570



54161550

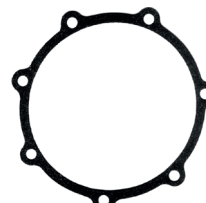

54154952

FORD CARGO PHASE I / II 6 CYLINDERS



54155798



54155596



54154683



54155631



54155498



54134973



RE02449S



RE02448S



5005449



54134150



5005167



54103841

84168040		KIT RUBBERS	
Nº ABR	DESCRIPTION	QTD	
50007841	SEAL 27,0X3,3 MM	4	
50008941	SEAL 55,0X2,0 MM	1	
50900741	SEAL 44,8X2,0 MM	1	
50013824	INJECTOR NOZZLE WASHERS	6	
50011041	SEAL 33,5X3,6 MM	1	
50010641	SEAL 24,0X3,8 MM	1	
50027341	SEAL 81,5X2,5 MM	1	
50010341	SEAL 23,0X3,5 MM	3	
50030041	SEAL 39,4X3,5 MM	3	
50050166	WASHERS FB 20,0X24,0X1,5 MM	1	
54103841	SEAL HASTE VÁLVULA	12	
50009928	ALUMINUM WASHERUMINIO 6,2X10,2X1,0 MM	12	
50040041	SEAL 18,0X2,5 MM	6	
50005141	SEAL 7,65X1,78 MM	2	
50034641	SEAL 11,6X1,5 MM	8	

84168026		KIT RUBBERS	
Nº ABR	DESCRIPTION	QTD	
50008941	SEAL 55,0X2,0 MM	1	
50013824	INJECTOR NOZZLE WASHERS	6	
54103841	SEAL HASTE VÁLVULA	12	
50009928	ALUMINUM WASHER 6,2X10,2X1,0 MM	12	
50040041	SEAL 18,0X2,5 MM	6	
50034641	SEAL 11,6X1,5 MM	8	

FORD DOFA DURATORQ TRANSIT 2.4 TDCI 16 VALVES

N° SET		DESCRIPTION		
64115132		FULL GASKET SET DOFA DURATORQ TRANSIT 2.4 TDCI 16V DOHC 2009 WITHOUT OIL SEAL	1	
74115132		FULL GASKET SET DOFA DURATORQ TRANSIT 2.4 TDCI 16V DOHC 2009 WITH OIL SEAL	2	
64135132		HEAD GASKET SET DOFA DURATORQ TRANSIT 2.4 TDCI 16V DOHC 2009 WITHOUT OIL SEAL	3	
74135132		HEAD GASKET SET DOFA DURATORQ TRANSIT 2.4 TDCI 16V DOHC 2009 WITH OIL SEAL	4	
N° ABR	N° ORIGINAL	DESCRIPTION		
54154602	5C1Q6051AA	CYLINDER HEAD GASKET	1	1
54175640	257Q6260AA	VALVE COVER GASKET	1	1
54175440	X57Q8565AA	INTAKE MANIFOLD GASKET	8	8
54175730	2C1Q9448AB	EXHAUST GASKET	1	1
54175030		THERMOSTATIC GASKET	1	1
54175231		WATER PUMP GASKET	1	1
54175830		REAR COVER GASKET	1	1
54175130		OIL FILTER GASKET	1	1
54176067		INLET OIL GASKET DO TURBO	1	1
54175330		WATER PUMP GASKET	1	1
84171630		OIL PAN GASKET	1	1
84171740		KIT WASHERSS AND RUBBERS	1	1
RE09084T		VALVE STEM SEAL	16	
RE09082T		REAR OIL SEAL	1	
RE09083T		FRONT OIL SEAL	1	

• SOLD SEPARATELY

APPLICATION



FORD TRANSIT TDCI 2009/12

FORD DOFA DURATORQ TRANSIT 2.4 TDCI 16 VALVES

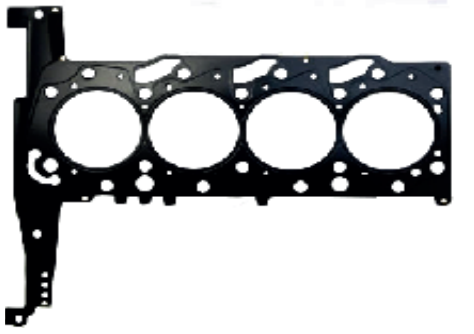

50965504

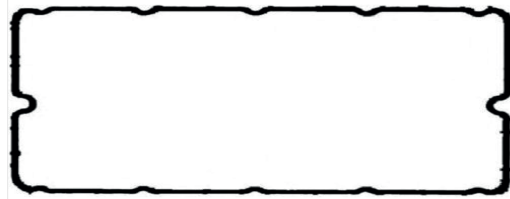

50918655



50965504

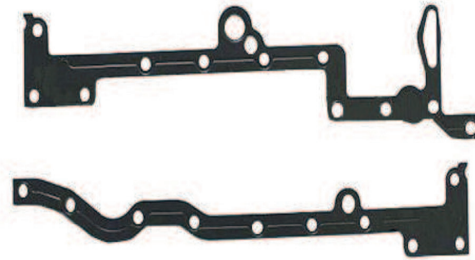

50918655



SSSSSSSS



50923990



SSSSSSSS



SSSSSSSS



50923990



SSSSSSSS

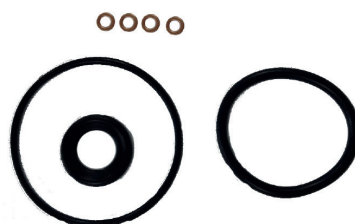

50923990

FORD RANGER DURATORQ TDCI OUMA 3.2 20 VÁLVULA DIESEL

N° SET		DESCRIPTION		
64115142		FULL GASKET SET RANGER DURATORQ 3.2 TDCI WITHOUT OIL SEAL		1
74115142		FULL GASKET SET RANGER DURATORQ 3.2 TDCI WITH OIL SEAL		2
64135142		HEAD GASKET SET RANGER DURATORQ 3.2 TDCI WITHOUT OIL SEAL		3
74135142		HEAD GASKET SET RANGER DURATORQ 3.2 TDCI WITH OIL SEAL		4
N° ABR	N° ORIGINAL	DESCRIPTION		
54174702	7C166051CB	CYLINDER HEAD GASKET	1	1
54174840	BK3Q6K260AA	VALVE COVER GASKET	1	1
84171530		OIL PAN GASKET	1	1
54175440	X57Q856AA	INTAKE MANIFOLD GASKET	10	10
54174930	7C169448AB	EXHAUST GASKET	1	1
54175231	YCH1Q6L50AD	WATER PUMP GASKET	2	2
54175030		THERMOSTATIC GASKET	1	1
54175130		OIL FILTER GASKET	1	1
54175330		WATER PUMP GASKET	1	1
84171640		KIT WASHERS AND RUBBERS	1	1
RE09084T		VALVE STEM SEAL	20	
RE09082T		REAR OIL SEAL	1	
RE09083T		FRNT OIL SEAL	1	

• SOLD SEPARATELY

APPLICATION



FORD RANGER TDCI 2012/...

TROLLER T4 TGV 2013/...

FORD RANGER DURATORQ TDCI OUMA 3.2 20 VÁLVULA DIESEL

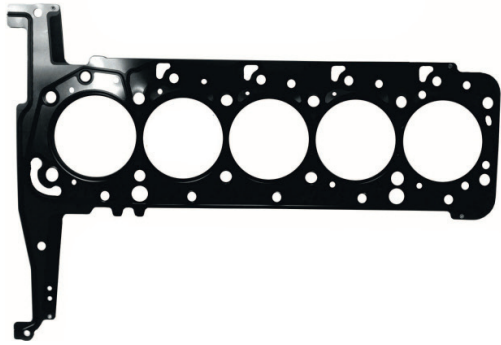

54174702

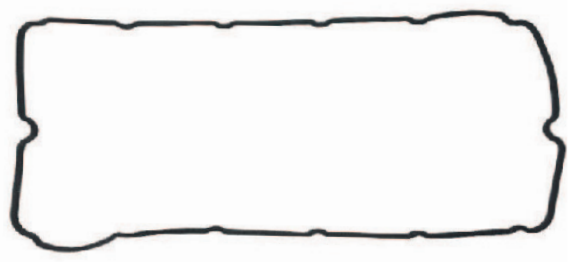

54174840



54174930



84171530



54175030



54175231



54175330



54175130



RE09083T



RE09082T



54175440



RE09084T

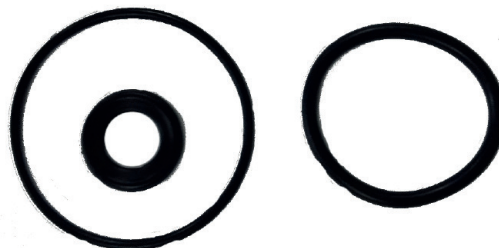

84171640

RANGER TRANSIT 2.2

N° SET		DESCRIPTION	
74115282		FULL GASKET SET TRANSIT 2.2 TDCI 16VALVES 2012/RANGER 2.2 2013 WITH OIL SEAL	1
74185282		FULL GASKET SET TRANSIT 2.2 TDCI 16VALVES 2012/RANGER 2.2 2013 WITH OIL SEAL	2

N° ABR	N° ORIGINAL	DESCRIPTION		
54176702	BK3Q6051A1C	CYLINDER HEAD GASKET		1
54176802	BK3Q6051C1C	CYLINDER HEAD GASKET		1
54176140	BK2Q6K260AA	VALVE COVER GASKET	1	1
54175730	2C1Q9448AB	EXHAUST GASKET	1	1
RE09083T	50X90X8,5/13,5	FRONT OIL SEAL	1	1
RE09117F	36X50X7	REAR OIL SEAL	2	2
RE09084T	5,5X12X18,5	VALVE STEM SEAL	16	16
54175440	XS7Q8565AA	INTAKE MANIFOLD GASKET	8	8
84171630	3S7Q6710AA	OIL PAN GASKET	1	1
RE09082T		REAR OIL SEAL		1
54175930	6C1Q9L461BB	TURBOCHARGING GASKET	1	1
54176067		INLET OIL GASKET DO TURBO	1	1
54175231	YC1Q6L050AD	WATER PUMP GASKET	1	1
84172040		KIT RUBBERS	1	1

• SOLD SEPARATELY

APPLICATION



FORD TRUCK TRANSIT 2012/14 RANGER 2013/

RANGER TRANSIT 2.2

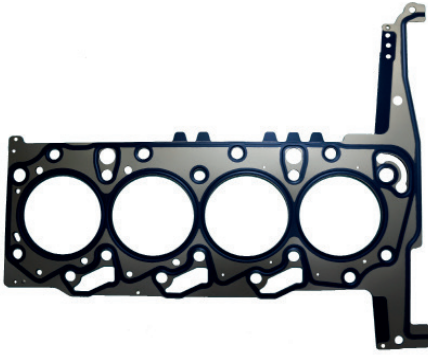

54176702



54176802

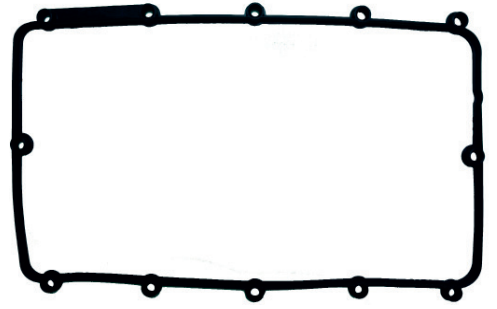

54176140

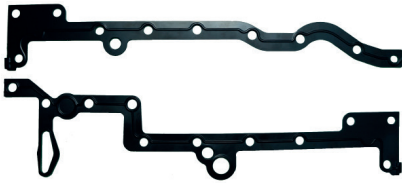

84171630



54175730



RE09083T



54175231



54176067



54175967



84172040



54175440



RE09117F



RE09082T



RE09084T

The VALTRA logo is centered on the page. It features a stylized icon on the left consisting of two parallel diagonal lines slanting upwards from left to right. To the right of this icon, the word "VALTRA" is written in a bold, uppercase, sans-serif font. The entire logo is rendered in a solid blue color. The logo is positioned in the center of the page, which is framed by a blue border that has a gap at the top and bottom.

VALTRA

N° ABR	ENGINE	DESCRIPTION	PAGE
64410121	420 DS	FULL GASKET SET WITHOUT OIL SEAL	274
64410141	420 DS	FULL GASKET SET WITHOUT OIL SEAL	274
64430121	420 DS	HEAD GASKET SET WITHOUT OIL SEAL	274
74410121	420 DS	FULL GASKET SET WITH OIL SEAL	274
74410141	420 DS	FULL GASKET SET WITH OIL SEAL	274
64410131	620 DS	FULL GASKET SET WITHOUT OIL SEAL	278
64410151	620 DS	FULL GASKET SET WITHOUT OIL SEAL	278
64430131	620 DS	HEAD GASKET SET WITHOUT OIL SEAL	278
64410161	620 DS	FULL GASKET SET WITHOUT OIL SEAL	278
64430161	620 DS	HEAD GASKET SET WITHOUT OIL SEAL	278
74410161	620 DS	HEAD GASKET SET WITH OIL SEAL	278

420 DS 4 CYLINDERS ASPIRETED

Nº JOGO	DESCRIPTION				
64410121	FULL GASKET SET 420 DS 4 CYLINDERS ASPIRATED TRACTOR 800/BL88 WITHOUT OIL SEAL				1
64410141	FULL GASKET SET 420 DS 4 CYLINDERS TURBO TRACTOR 900/BM85/BM110/WITHOUT OIL SEAL				2
64430121	HEAD GASKET SET 420 DS 4 CYLINDERS ASPIRATED TURBO TRACTOR 800/900/BM85/110 WITHOUT OIL SEAL				3
74410121	FULL GASKET SET 420 DS 4 CYLINDERS ASPIRATED TRACTOR 800/BL88 WITH OIL SEAL				4
74410141	FULL GASKET SET 420 DS 4 CYLINDERS TURBO TRACTOR 900/BM85/RETBM110 WITH OIL SEAL				5

Nº ABR	Nº ORIGINAL	DESCRIPTION					
54416018	23589880032	TURBOCHARGING GASKET	1	1	1		
54416367	835324277	HYDRAULLIC PUMP GASKET	1	1	1	1	1
54424136	836740277	TURBOCHARGING GASKET	1	1	1		
54423147	836338985	ELBOW TURBOCHARGING GASKET	1	1	1		
54423067	836324580	OUTLET OIL GASKET	1	1	1		
54420367	845008344	OIL RETURN GASKET	1	1	1		
54421967	836008449	OIL TUBE GASKET	1	1	1	1	1
54423667	836122282	OIL PUMP GASKET	1	1	1	1	1
54421867	836008856	PRESSURE VALVE GASKET	1	1	1	1	1
54420667	836647401	FUEL PUMP GASKET	1	1	1	1	1
54424767	836659544	FUEL PUMP GASKET	1	1	1	1	1
54423967	836640335	FUEL PUMP GASKET	1	1	1	1	1
84400826		KIT WASHERS	1	1	1	1	1
84400940		KIT RUBBERS	1	1	1	1	1
84401440		KIT HEAD WASHERS AND RUBBERS			1		
54424236	836316726	TURBOCHARGING GASKET	1	1	1	1	1
54422267	836647866	INJECTOR PUMP GASKET	1	1	1	1	1
54421067	836747595	INTAKE MANIFOLD GASKET	1	1	1	1	1
54421150	836746362	VALVE COVER GASKET	1	1	1	1	1
54420867	836107726	OIL PAN GASKET	1	1	1	1	1
54422450	836107726	OIL PAN GASKET	1	1	1	1	1
54483040	836647503	LINER RING GASKET	12			12	12
54482800	836664155	CYLINDER HEAD GASKET	1	1	1	1	1
54421267	836647419	TIMING CASE COVER GASKET	1	1	1	1	1
54422067	83536796	FRONT TIMING CASE COVER GASKET	1	1	1	1	1
54421667	836119349	THERMOSTATIC HOUSING GASKET	1	1	1	1	1
54421367	836649343	THERMOSTATIC HOUSING GASKET	1	1	1	1	1
54421567	836120128	WATER PUMP GASKET	1	1	1	1	1
54421467	836120129	OIL BREATHER GASKET	1	1	1	1	1
54422167	835336793	BEARING COVER GASKET	1	1	1	1	1
54420567	836129946	FRONT COVER GASKET	1	1	1	1	1
54421771	836014198	OIL PUMP GASKET	1	1	1	1	1
RE00186F		REAR OIL SEAL	1	1			
RE00185F		FRONT OIL SEAL	1	1			

• SOLD SEPARATELY

APPLICATION



VALTRA SISU 420D 4 CYLINDERS 4.4LLITER ASPIRATE

VALTRA TRACTOR 800 2001/06 885S/985S 1994/09 BL88 2006/11

VALTRA SISU 420DS 4 CYLINDERS 4.4LLITER TURBO

VALTRA TRACTOR 900 2001/06 A950 2008/17 BM85/100/110 2002/18 BM15i 2001/17

420 DS 4 CYLINDERS ASPIRETED

APPLICATION



VALTRA SISU 420D 4 CYL.4.4L ASPIRATE

VALTRA TRACTOR 800 2001/06 885S/985S 1994/09 BL88 2006/11

VALTRA SISU 420DS 4 CYL.4.4L TURBO

VALTRA TRACTOR 900 2001/06 A950 2008/17 BM85/100/110 2002/18 BM15i 2001/17

420 DS 4 CYLINDERS ASPIRETED

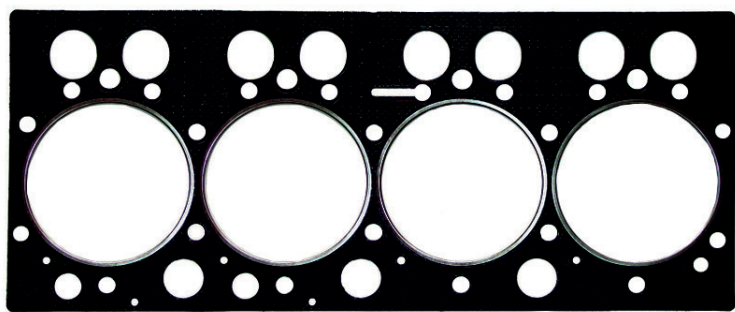

54482800

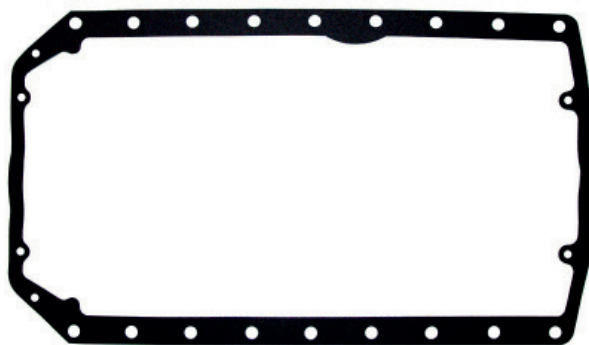

54420867



5442267

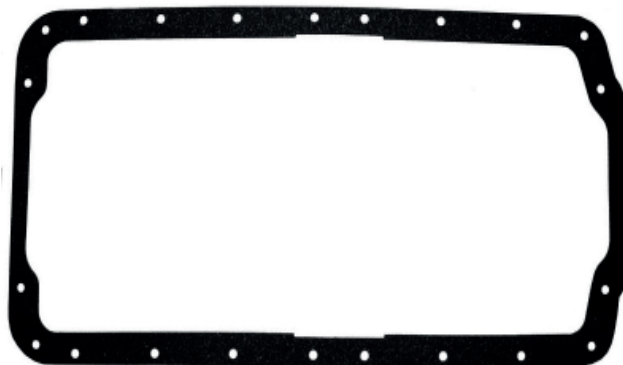

54422450



54421567



54421467

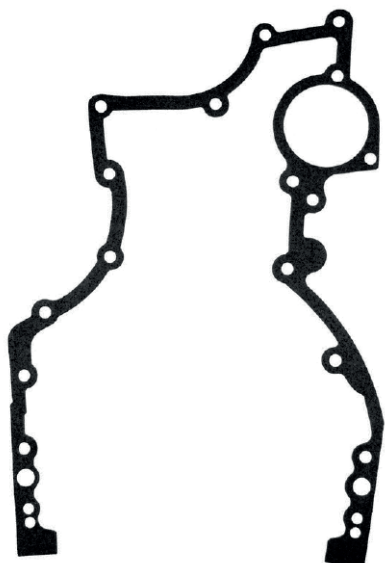

54421267



54421150



54421067

420 DS 4 CYLINDERS ASPIRETED



54482800



54420867



54420367



54423067



54423667



54421867



54421667



54420667



54423967

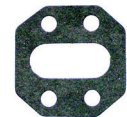

54424767



54421771



54422167



54420367



54416367



54422267



54424136



54424236



54416018

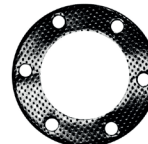

54423147

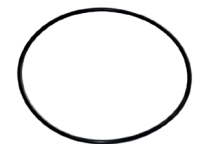

54483040



RE00185F



RE00186F

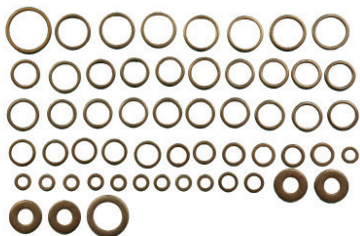

84400826

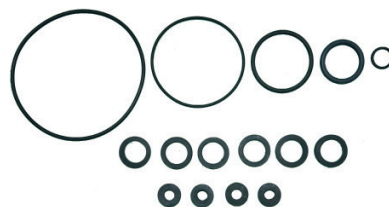

84400940

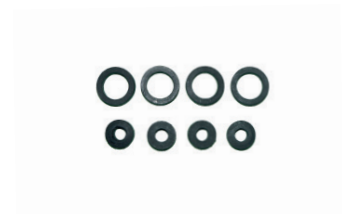

84401440

Nº JOGO	DESCRIPTION
64410131	FULL GASKET SET 620 DS 6 CYLINDERS WITHOUT OIL SEAL
64410151	FULL GASKET SET 620 DS 6 CYLINDERS WITHOUT OIL SEAL
74410151	FULL GASKET SET 620 DS 6 CYLINDERS WITH OIL SEAL
64430131	HEAD GASKET SET 620 DS 6 CYLINDERS WITHOUT OIL SEAL
64410161	FULL GASKET SET 320 DS 3 CYLINDERS WITHOUT OIL SEAL
64430161	HEAD GASKET SET 320 DS 3 CYLINDERS WITHOUT OIL SEAL
74410161	FULL GASKET SET 320 DS 3 CYLINDERS WITH OIL SEAL

Nº ABR	Nº ORIGINAL	DESCRIPTION								
54416018	2358980032	TURBOCHARGING GASKET	1	1	1					
54416367	835324277	HYDRAULIC PUMP GASKET				1	1	1	1	
54420367	845008344	OIL RETURN GASKET				1	1	1		
54420567	836129946	FRONT COVER GASKET	1		1			1	1	1
54420667	836647401	FUEL PUMP GASKET						1	1	1
54421267	836647419	TIMING CASE COVER GASKET	1		1			1	1	1
54421367	836649393	THERMOSTATIC HOUSING GASKET	1	1	1	1	1	1	1	1
54421467	836120129	OIL BREATHER GASKET	1		1					
54421537	836120128	WATER PUMP GASKET	1		1					
54421667	836119849	THERMOSTATIC GASKET	1	1	1	1	1	1	1	1
54421771	836014198	OIL PUMP GASKET	1		1			1	1	1
54421867	836008856	PRESSURE VALVE GASKET						1	1	1
54421967	836008449	OIL TUBE GASKET	1		1			2	2	2
54422067	83536796	FRONT TIMING CASE COVER GASKET	1		1			1	1	1
54422167	835336793	BEARING COVER GASKET	1		1			1	1	1
54422267	836647866	INJECTOR PUMP GASKET	1		1			1	1	1
54423567		OIL PAN GASKET						2	2	2
54422567	836846304	WATER PUMP GASKET						1	1	1
54422667	836846305	WATER PUMP GASKET						1	1	1
54422867	836847496	INTAKE MANIFOLD GASKET	1	1	1	2	2	2	2	2
54422950	836646360	VALVE COVER GASKET	1	1	1	2	2	2	2	2
54423067	836324580	OUTLET OIL GASKET				1	1	1		
54423147	836338985	ELBOW TURBOCHARGING GASKET				1	1	1		
54423367	836847532	OUTLET MANIFOLD GASKET				1	1	1	1	1
54423467		REAR COVER GASKET						1	1	1
54423567	836322183	OIL PAN GASKET						1	1	1
54423667	836122282	OIL PUMP GASKET						1	1	1
54423967	836640335	FUEL PUMP GASKET	1		1			1	1	1
54424236	836316726	TURBOCHARGING GASKET				1	1	1		
54424767	836659544	FUEL PUMP GASKET						1	1	1
54424867	836855417	REAR COVER CYLINDER HEAD GASKET	2	2	2	2	2	2	2	2
54424967		OIL PAN GASKET	1		1			1	1	1
54425067	836855418	PLATE CONECTION GASKET				1	1	1	1	1
54425550	836006704	OIL PAN GASKET	1		1					
54482900	836647503	CYLINDER HEAD GASKET	1	1	1	2	2	2	2	2
54483040		LINER RING	9		9			18	18	18
84400440		KIT RUBBERS						1	1	1
84400520		KIT RUBBERS						1	1	1
84401140		KIT WASHERS						1		
84401226		KIT WASHERS						1		
84401340		KIT HEAD WASHERS			1					
84401540		KIT HEAD WASHERS AND RIBBERS						1		
RE00186F		REAR OIL SEAL	1					1		
RE00185F		FRONT OIL SEAL	1					1		
RE09110F		VALVE STEM SEAL						24		

● SOLD SEPARATELY

APPLICATION

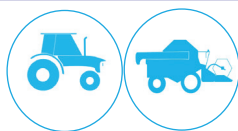

VALTRA SISU 320D ASPIRATE/320 DS 3 CYLINDERS.3.3L TURBO

VALTRA TRACTOR A650F/750F/850F/950F 2009/17 A650/750 2007/17 A850 2008/17 BF65 2005/13 BF75/77 2008/14 BL77 2006/11 700 1994/06

VALTRA SISU 620D 6 CYLINDERS 6.6L ASPIRATE

VALTRA TRACTOR 1180S 1996/08 1380S 1994/09 1680 1997/08 1880S 1996/09 BM120 2001/11

VALTRA SISU 620DS 6 CYLINDERS 6.6L TURBO

M.FERGUSON TRACTOR MF 6350 2003/10 MF 7390 2008/16 MF 7140/7150/7170/7180/7350/7370 2008/18

M.FERGUSON COLHEITADEIRA MF32 2009/16 MF 5650 1997/16

VALTRA TRACTOR BH145 900 2004/16 BH160 2001/10 BH165 2004/16 BH180 2003/17 BH180i 2003/14

BM185i 2001/17 BH205i 2008/16 BH210i 2007/16 BT150 2008/17 BT170/190 2010/17 BH140 2002/12

VALTRA COLHEITADEIRA BC4500 2007/15

VALTRA 620 DS G CYLINDERS / 320 DS 3 CYLINDERS

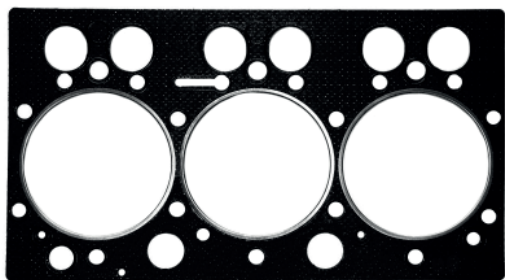

54482900

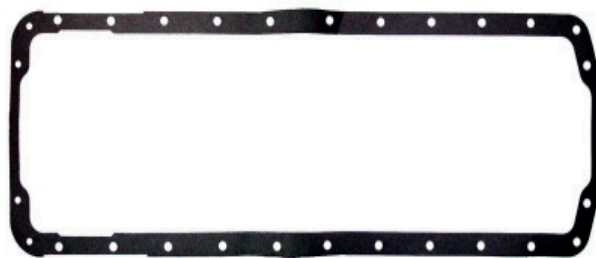

54423567



5442267

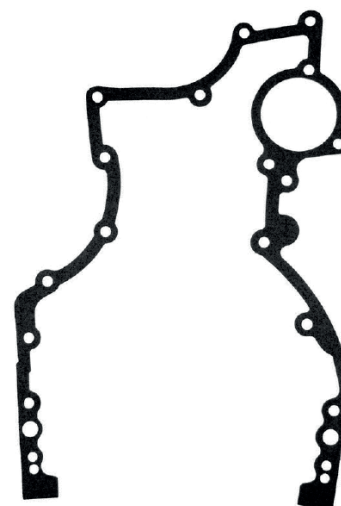

54421267

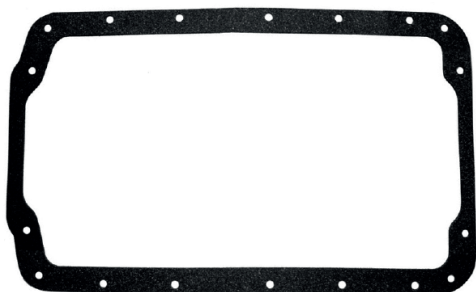

54425550



54422867



54422950



54422567



54422667



54421567

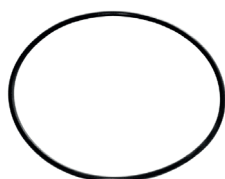

54483040

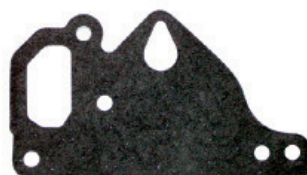

54421467



54424236

VALTRA 620 DS G CYLINDERS / 320 DS 3 CYLINDERS



84400440		KIT RUBBERSS	
N° ABR	DESCRIPTION	QTD	
50037341	OIL SEAL 15,0X2,5 MM	1	
54387340	OIL SEAL 80,0X2,5 MM	1	
50096240	OIL SEAL 10,0X21,0X8,0 MM	2	
50096340	OIL SEAL 20,0X58,0X7,0 MM	3	

84401340		KIT RUBBERSS	
N° ABR	DESCRIPTION	QTD	
50096240	OIL SEAL 10,0 X 21,0 X 8,0 MM	2	
50096340	OIL SEAL 20,0 X 28,6 X 7,0 MM	3	
50019723	COPPER WASHER 13,0 X 17,0 X 1,0 MM	6	
50021124	COPPER WASHER 14,0 X 18,0 X 1,5 MM	1	
50014120	COPPER WASHER 9,5 X 20,0 X 2,0 MM	3	
50069224	COPPER WASHER 18,0 X 22,0 X 1,5 MM	2	
50023624	COPPER WASHER 16,0 X 20,0 X 1,5 MM	2	
50092723	COPPER WASHER 12,0 X 16,0 X 1,0 MM	1	
50009923	COPPER WASHER 6,0 X 10,0 X 1,0 MM	7	

84400526		KIT RUBBERSS	
N° ABR	DESCRIPTION	QTD	
50029720	COPPER WASHER 24,0 X 29,0 X 2,0 MM	1	
50019723	COPPER WASHER 13,0 X 17,0 X 1,0 MM	3	
50021124	COPPER WASHER 14,0 X 18,0 X 1,5 MM	1	
50014120	COPPER WASHER 9,5 X 20,0 X 2,0 MM	6	
50069224	COPPER WASHER 18,0 X 22,0 X 1,5 MM	10	
50015722	COPPER WASHER 10,0 X 13,8 X 0,8 MM	7	
50023624	COPPER WASHER 16,0 X 20,0 X 1,5 MM	3	
50009923	COPPER WASHER 6,0 X 10,0 X 1,0 MM	14	

84401226		KIT RUBBERSS	
N° ABR	DESCRIPTION	QTD	
50019723	COPPER WASHER 13,0 X 17,0 X 1,0 MM	6	
50021124	COPPER WASHER 14,0 X 18,0 X 1,5 MM	15	
50014120	COPPER WASHER 9,5 X 20,0 X 2,0 MM	3	
50069224	COPPER WASHER 18,0 X 22,0 X 1,5 MM	6	
50015722	COPPER WASHER 10,0 X 13,8 X 0,8 MM	4	
50023624	COPPER WASHER 16,0 X 20,0 X 1,5 MM	2	
50092723	COPPER WASHER 12,0 X 16,0 X 1,0 MM	1	
50009923	COPPER WASHER 6,0 X 10,0 X 1,0 MM	7	

84401540		KIT RUBBERSS	
N° ABR	DESCRIPTION	QTD	
50095640	SEAL 30,0 X 5,0 MM	2	
50096240	SEAL 10,0 X 21,0 X 8,0 MM	4	
50096340	SEAL 20,0 X 28,6 X 7,0 MM	6	
50021124	COPPER WASHER 14,0 X 18,0 X 1,5 MM	1	
50014120	COPPER WASHER 9,5 X 20,0 X 2,0 MM	6	
50069224	COPPER WASHER 18,0 X 22,0 X 1,5 MM	2	
50009923	COPPER WASHER 6,0 X 10,0 X 1,0 MM	14	

84400440		KIT RUBBERSS	
N° ABR	DESCRIPTION	QTD	
50037341	OIL SEAL 15,0 X 2,5 MM	1	
50095640	OIL SEAL 30,0 X 5,0 MM	2	
50095740	OIL SEAL 47,0 X 4,0 MM	1	
50087340	OIL SEAL 80,0 X 2,5 MM	1	
50096240	OIL SEAL 10,0 X 21,0 X 8,0 MM	4	
50096340	OIL SEAL 20,0 X 28,6 X 7,0 MM	6	

// FIAT

// GM

// HYUNDAI

// VOLKSWAGHEN

// NISSAN

// NEW RELEASES

// MAN

// MITSUBISHI

// VALTRA

// TOYOTA

// FORD

// KIA-ASIA

CHEVROLET XLD28 DURAMAX 2.8 LITER 16 VALVE

N° SET		DESCRIPTION		
74012532	FULL GASKET SET 2.8 LITER 16 VALVE WITH OIL SEAL		1	
74032532	HEAD GASKET SET 2.8 LITER 16 VALVE WITH OIL SEAL		2	
N° ABR	N° ORIGINAL	DESCRIPTION		
54036602	12625493	HEAD CYLINDER GASKET	1	1
54037030	12642186	EXHAUST MANIFOLD GASKET	1	1
54036940	12637739	INTAKE MANIFOLD GASKET	1	1
54037630	12625684	INTAKE MANIFOLD GASKET	1	1
84037240	12643582	VALVE COVER GASKET	1	1
54037130	12644922	FRONT COVER GASKET		1
54036725	12625698	OIL PAN GASKET		1
54036825	12629737	REAR OIL PAN GASKET		1
RE05832F	12643566	REAR CRANKSHAFT OIL SEAL		1
RE05831F	12642203	FRONT CRANKSHAFT OIL SEAL		1
RE05834F	12643564	CAMSHAFT SEAL(PLUG)		1
RE05833F	12643563	CAMSHAFT SEAL	1	1
UE09203F	90410741	VALVE STEM SEAL	16	16
54037318	94721659	EXHAUST TUBE GASKET	1	1
54037567	12641665	ERGONOMIC VALVE GASKET	1	1
54037467	12641663	ERGONOMIC VALVE GASKET	1	1
84037740		KIT RUBBERS	1	1

• SOLD SEPARATELY

APPLICATION



CHEVROLET XLD28 DURAMAX 2.8 LITER 16 VALVE
CHEVROLET S10/TRAILBLAZER 2012/...

CHEVROLET XLD28 DURAMAX 2.8 LITER 16 VALVE

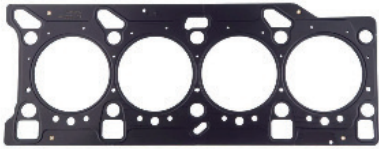

54036602-ESPESSURA 1,10MM

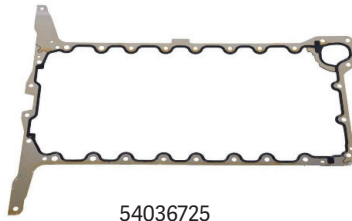

54036725



84037240



54037630



54037030



540336940



54037130



54036825



54037567



54037318



54037467



RE05834F



RE05832F



RE05833F



RE05831F



RE09203F

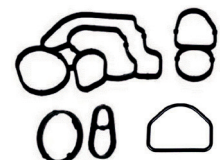

84037740



ROAD DAS CASTANHEIRAS 200 - GALPÃO 34 - JARDIM SÃO PAULO -

HORTOLÂNDIA TELEPHONE : 19 3116-0145

E-MAIL : CONTATO@ABR.IND.BR

WWW.ABR.IND.BR

2022